

RECKNAGEL

Katalog 10



150 Jahre

1867 - 2017

Aufkippmontagen

Slide-off mounts

Montages à glissièreSeiten 2 - 43

Einhakmontagen

German claw mounts

Montages à crochetsSeiten 44 - 51

Brückenmontagen

One piece swing mounts

Montages „pont“Seiten 52 - 60

Schwenkmontagen

Swing mounts

Montages pivotantsSeiten 61 - 140

Schwenkmontagenzubehör

Accessories for swing mounts

Pièces détachées pour montages pivotantsSeiten 141 - 152

Werkstattzubehör

Tools and screws

OutillageSeiten 153 - 160

© Copyright RECKNAGEL GmbH & Co. KG 2017

Nachdruck, auch auszugsweise, nur mit unserer
Genehmigung gestattet.

Katalog 10 - 03/2017

Layout und Satz: kraus print u. media
Fotos: Peter Leutsch

Technische Änderungen und Irrtümer vorbehalten.

1867

In Albrechts (bei Suhl in Thüringen) fängt alles an. Der Gewehrschlosser Adolf Recknagel wagt den Schritt in die Selbständigkeit, um sein bei J.P. Sauer & Sohn erlerntes Wissen in eigene Produkte umzusetzen. Er fertigt zunächst Visierungen und andere Teile für Suhler Gewehrfabriken. Mit dem Einstieg seines Sohnes und des Schwiegersohnes wird die Firma zu Reitz & Recknagel.

1933

Christian Recknagel, Enkel des Gründers Adolf Recknagel, führt nun die Firma. Die Familie Reitz scheidet aus. Der Firmenname bleibt.

1945

Reitz & Recknagel fällt der Demontage durch die sowjetische Besatzungsmacht zum Opfer. Der Privatbesitz wird enteignet. Christian Recknagel verlässt Thüringen und findet eine neue Heimat in Bayern.

1948

Neubeginn in Schweinfurt. Christian Recknagel fertigt zunächst Haushaltsartikel. Nach Neu-Erteilung der Genehmigung Waffenteile herzustellen wird die Fertigung von Visiereinrichtungen wieder aufgenommen.

1950

Erich Recknagel, Sohn von Christian Recknagel wird Teilhaber in der Firma seines Vaters.

1961

Nach dem Tod von Christian Recknagel bezieht Erich Recknagel sein neues Firmengebäude in Schweinfurt.

1969

Georg Recknagel, Sohn von Erich Recknagel, wird Teilhaber und übernimmt später die Firma, welche sich jetzt „G. C. Recknagel Feintechnik“ nennt.

2000

Georg Recknagel übergibt seine Firma in 6. Generation an seine Tochter Gabriele Recknagel.

2006

Umzug von Schweinfurt nach Bergheinfeld, wo ein größeres Firmengebäude ausreichend Platz für eine wachsende Zahl an Mitarbeitern und Maschinen bietet.

2010

Recknagel bringt unter dem Markennamen „ERATAC“ taktische Montagen und Zubehör für den zivilen und behördlichen Sektor auf den Markt.

2016

Recknagel erweitert ihre umfangreiche Produktpalette um moderne, leichte Jagdschalldämpfer.

2017

Unter der Führung von Gabriele Recknagel begeht die Firma ihr 150 jähriges Firmenjubiläum!

It all begins in 1867,

in Albrechts (near Suhl in Thuringia). The gunsmith Adolf Recknagel takes his first step into self-employment by putting the knowledge he acquired from J.P. Sauer & Son into his own products. He initially manufactures sights and further items for gun factories in Suhl. His son and son-in-law join the company, which is now named Reitz & Recknagel.

1933

Christian Recknagel, grandson of the founder, runs the company. The Reitz Family is no longer involved. The company name remains unchanged.

1945

Reitz & Recknagel cease to exist as a result of the dismantlement by the Russian occupying powers. All private property is expropriated. Christian Recknagel leaves Thuringia and finds a new home in Bavaria.

1948

New beginnings in Schweinfurt. Christian Recknagel produces household goods. After receiving a new license for manufacturing rifle parts, he starts to produce sights again.

1950

Erich Recknagel, son of Christian Recknagel, becomes shareholder in his father's company.

1961

After the death of Christian Recknagel, Erich Recknagel moves into another company building in Schweinfurt.

1969

Georg Recknagel, son of Erich Recknagel, becomes a shareholder and takes over 100% later on. The company is now named "G. C. Recknagel Feintechnik".

2000

Georg Recknagel hands over his shares to his daughter Gabriele Recknagel, the 6th generation.

2006

The company moves from Schweinfurt to Bergheinfeld, where a bigger company building provides enough space for a growing number of employees and machinery.

2010

Recknagel launches a new product line. Under the name "ERATAC", the company manufactures tactical mounts and accessories for the civil and the military sector.

2016

Recknagel extends the comprehensive product portfolio with modern, light-weight hunting silencers.

2017

Under the leadership of Gabriele Recknagel the company celebrates its 150th anniversary!

Slide-off / tip-off mounts for 11 mm dovetail / Montages à glissière et basculants pour 11 mm de prisme



Aufkippmontage aus Aluminium, mit Klemmbacken und Rändelschrauben.
Bauhöhe: 14 mm

ø 1"/26 mm

40226-1400



Aufschubmontage aus Aluminium, mit Rändelmutter und Durchsicht.
Bauhöhe: 18 mm

ø 1"/26 mm

40426-1800



Aufkippmontage aus Aluminium, mit Klemmbacken und großer Durchsicht.
Bauhöhe: 26,5 mm

ø 1"/26 mm

40626-2650



Aufschubmontage aus Stahl mit federnden, einstellbaren Gegendruck-Klemmschiebern; ohne Support. Bauhöhe: 20 mm

ø 30 mm

41330-2000



Aufschubmontage aus Stahl, mit federnden, einstellbaren Gegendruck-Klemmschiebern; mit Support. Bauhöhe: 20 mm

ø 30 mm

41430-2000



Aufkippmontage mit federnden, einstellbaren Gegendruck-Klemmschiebern und schräggeteilten Ringen.



Aufkippmontage mit federnden, einstellbaren Gegendruck-Klemmschiebern u. 70°-Aufnahmeprismen für Zielfernrohre mit Mittelrohrschiene.

BH [mm]	ohne Support ø 1"/26 mm	ohne Support ø 30 mm	ohne Support ø 34 mm	ohne Support ø 36 mm	ohne Support ø 40 mm
17,0	42226-0500	42230-0500	42234-0500	42236-0500	42240-0500
22,0	42226-1000	42230-1000	42234-1000	42236-1000	42240-1000
30,0	42226-1800	42230-1800	42234-1800	42236-1800	

BH [mm]	mit Support ø 1"/26 mm	mit Support ø 30 mm	mit Support ø 34 mm	mit Support ø 36 mm	mit Support ø 40 mm
17,0	42326-0500	42330-0500	42334-0500	42336-0500	42340-0500
22,0	42326-1000	42330-1000	42334-1000	42336-1000	42340-1000
30,0	42326-1800	42330-1800	42334-1800	42336-1800	

BH [mm]	ohne Support	mit Support
16,0	42270-0400	42370-0400
21,0	42270-0900	42370-0900

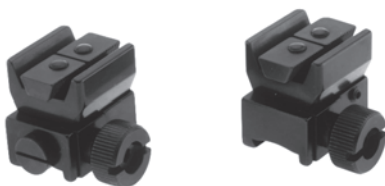

Aufkippmontage mit federnden, einstellbaren Gegendruck-Klemmschiebern und 45°-Aufnahmeprismen.



Aufkippmontage mit federnden, einstellbaren Gegendruck-Klemmschiebern für Swarovski SR-Zielfernrohre mit Innenschiene und Zahnprofil.



Aufkippmontage mit federnden, einstellbaren Gegendruck-Klemmschiebern für S&B-Convex-Schiene.

BH [mm]	ohne Support	mit Support
18,0	42245-0600	42345-0600

BH [mm]	ohne Support	mit Support
17,0	42253-0500	42353-0500

BH [mm]	ohne Support	mit Support
15,0	42267-0300	42367-0300

AUFSCHUBMONTAGEN für KIPPLAUFWAFFEN mit 14,5 mm Prisma



Slide-off mounts for break open guns for 14,5 mm dovetail / Montages à glissière pour 14,5 mm de prisme

Aufschubmontagen mit Support und zwei federnden Klemmschiebern, für Brüner und Heym BBF. Diese Montagen können sowohl mit Ringen als auch mit Aufnahmeprisma geliefert werden.



BH [mm]	ø 1"/26 mm	ø 30 mm	ø 34 mm	ø 36 mm	ø 40 mm
17,5	46226-0500	46230-0500	46234-0500	46236-0500	46240-0500
22,5	46226-1000	46230-1000	46234-1000	46236-1000	46240-1000
30,5	46226-1800	46230-1800	46234-1800	46236-1800	

BH [mm]	70°	BH [mm]	45°	BH [mm]	Swarovski SR	BH [mm]	S&B-Convex
16,5	46270-0400	18,5	46245-0600	17,5	46253-0500	15,5	46267-0300
21,5	46270-0900						

AUFKIPPMONTAGEN für 16 mm Prisma



Tip-off mounts for 16 mm dovetail / Montages basculants pour 16 mm de prisme



Aufkippmontage aus Aluminium, ohne Support, mit Anschlag, Rändelschrauben und federnden Gegendruck-Klemmschiebern. Bauhöhe: 15 mm. Für die Repetierbüchsen Brüner Modell Fox und Tikka Modelle 55 / 65 / 558 / 658.

ø 1"/26 mm	ø 30 mm
43026-1500	43030-1500

Aufkippmontagen für 16 mm Prisma mit Rändelschrauben und federnden, einstellbaren Gegendruck-Klemmschiebern. Für die Repetierbüchsen Brüner Modell Fox und Tikka Modelle 55 / 65 / 558 / 658. Die Klemmringe und Aufnahmeprismen können ausgetauscht werden. Montagefüße aus Stahl gibt es in kurzer und verlängerter Ausführung sowie jeweils mit und ohne Support.

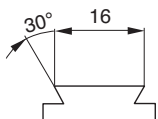

	BH [mm]	ø 1"/26 mm	ø 30 mm	ø 34 mm	ø 36 mm	ø 40 mm	BH [mm]	Aufnahmeprisma 70°
kurze Ausführung, ohne Support	14,0	44026-0500	44030-0500	44034-0500	44036-0500	44040-0500	13,0	44070-0400
	19,0	44026-1000	44030-1000	44034-1000	44036-1000	44040-1000	18,0	44070-0900
	27,0	44026-1800	44030-1800	44034-1800	44036-1800			
kurze Ausführung, mit Support	14,0	44126-0500	44130-0500	44134-0500	44136-0500	44140-0500	13,0	44170-0400
	19,0	44126-1000	44130-1000	44134-1000	44136-1000	44140-1000	18,0	44170-0900
	27,0	44126-1800	44130-1800	44134-1800	44136-1800			
um 10,5 mm verlängerte Ausführung, ohne Support	14,0	44226-0500	44230-0500	44234-0500	44236-0500	44240-0500	13,0	44270-0400
	19,0	44226-1000	44230-1000	44234-1000	44236-1000	44240-1000	18,0	44270-0900
	27,0	44226-1800	44230-1800	44234-1800	44236-1800			
um 10,5 mm verlängerte Ausführung, ohne Support	14,0	44326-0500	44330-0500	44334-0500	44336-0500	44340-0500	13,0	44370-0400
	19,0	44326-1000	44330-1000	44334-1000	44336-1000	44340-1000	18,0	44370-0900
	27,0	44326-1800	44330-1800	44334-1800	44336-1800			

Tip-off mounts for 16 mm dovetail / Montages basculants pour 16 mm de prisme

Aufkippmontage mit federnden, einstellbaren Gegendruck-Klemmschiebern



BH [mm]	Aufnahmeprisma 45°		BH [mm]	Swarovski SR		BH [mm]	S&B-Convex	
	ohne Support	mit Support		ohne Support	mit Support		ohne Support	mit Support
15,0 / kurz	44045-0600	44145-0600	14,0 / kurz	44053-0500	44153-0500	12,0 / kurz	44067-0300	44167-0300
15,0 / verlängert	44245-0600	44345-0600	14,0 / verlängert	44253-0500	44353-0500	12,0 / verlängert	44267-0300	44367-0300

AUFKIPPMONTAGEN mit 19,5 mm Prisma für Brüner-ZKK

Tip-off mounts for 19,5 mm dovetail for Brüner ZKK / Montages basculants pour 19,5 mm de prisme Brüner ZKK

Montagefüsse aus Aluminium, verlängerte Ausführung, mit federnden Klemmschiebern und Rändelmutter, seitlich verstellbar.

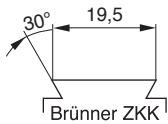

BH [mm]	ø 1"/26 mm	ø 30 mm	ø 34 mm	ø 36 mm	ø 40 mm	BH [mm]	Aufnahmeprisma 70°		
							um 15,0 mm verlängerte Ausführung	17,0	45026-0563
								21,0	45070-0963



BH [mm]	Aufnahmeprisma 45°		BH [mm]	Swarovski SR	BH [mm]	S&B-Convex
	um 15,0 mm verlängerte Ausführung	18,0				

AUFKIPPMONTAGEN für Steyr SSG 69

Tip-off mounts for Steyr SSG 69 / Montages basculants pour Steyr SSG 69

Montagefüsse aus Stahl, mit federnden Klemmschiebern, seitlich Verstellbar, Befestigung über Rändelschrauben.



BH [mm]	ø 1"/26 mm	ø 30 mm	ø 34 mm	ø 36 mm	ø 40 mm	BH [mm]	Aufnahmeprisma 70°
							14,0
19,0	43126-1000	43130-1000	43134-1000	43136-1000	43140-1000	18,0	43170-0900
27,0	43126-1800	43130-1800	43134-1800	43136-1800			



BH [mm]	Aufnahmeprisma 45°		BH [mm]	Swarovski SR	BH [mm]	S&B-Convex
	15,0	43145-0600				

AUFKIPPMONTAGEN mit BASEN für Repetierbüchsen

Tip-off mounts with bases for bolt action rifles / Montages basculants avec embasses pour carabine à répétition

Aufkippmontagen mit einstellbaren, federnden Gegendruck-Klemmschiebern, 16 mm Prisma und Basen zur Befestigung auf der Hülse.
Die Montagen sind lieferbar in kurzer und verlängerter Ausführung jeweils ohne und mit Support.
Sie erhalten diese wahlweise mit Klemmrings bzw. für verschiedene Zielfernrohrschienen.

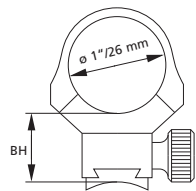

kurze Ausführung



Fabrikat	Modell	ohne Support			mit Support		
		BH 17,5 mm	BH 22,5 mm	BH 30,5 mm	BH 17,5 mm	BH 22,5 mm	BH 30,5 mm
Anschütz	1780 /1781	45426-052B	45426-102B	45426-182B	45526-052B	45526-102B	45526-182B
Benelli	ARGO	45426-0576	45426-1076	45426-1876	45526-0576	45526-1076	45526-1876
FN Browning	A-Bolt	45426-0520	45426-1020	45426-1820	45526-0520	45526-1020	45526-1820
	A-Bolt III	45426-052T	45426-102T	45426-182T	45526-052T	45526-102T	45526-182T
	BAR	45426-0503	45426-1003	45426-1803	45526-0503	45526-1003	45526-1803
	Maral	45426-052J	45426-102J	45426-182J	45526-052J	45526-102J	45526-182J
Haenel	Jäger 10 (ab Serien-Nr. JX-000921)	45426-052C	45426-102C	45426-182C	45526-052C	45526-102C	45526-182C
	SLB 2000+	45426-052I	45426-102I	45426-182I	45526-052I	45526-102I	45526-182I
H&K	SLB 2000	45426-0508	45426-1008	45426-1808	45526-0508	45526-1008	45526-1808
Howa	1500	45426-0559	45426-1059	45426-1859	45526-0559	45526-1059	45526-1859
Mauser	K 98 (und Nachbauten)	45426-0510	45426-1010	45426-1810	45526-0510	45526-1010	45526-1810
	M 12	45426-052L	45426-102L	45426-182L	45526-052L	45526-102L	45526-182L
Merkel	SR1 Basic	45426-052D	45426-102D	45426-182D	45526-052D	45526-102D	45526-182D
Remington	700 (Gewinde UNS 6-48)	45426-0512	45426-1012	45426-1812	45526-0512	45526-1012	45526-1812
	7400/7600/750	45426-0513	45426-1013	45426-1813	45526-0513	45526-1013	45526-1813
RWS-Röbler	Titan 3 / Titan 6 / Titan α	45426-0592	45426-1092	45426-1892	45526-0592	45526-1092	45526-1892
	Titan 16	45426-052G	45426-102G	45426-182G	45526-052G	45526-102G	45526-182G
Sauer	101	45426-052K	45426-102K	45426-182K	45526-052K	45526-102K	45526-182K
	200	45426-0516	45426-1016	45426-1816	45526-0516	45526-1016	45526-1816
	202	45426-0580	45426-1080	45426-1880	45526-0580	45526-1080	45526-1880
Steyr-Mannlicher	SBS-96 Exp./Pro Hunter/Classic/SM12/CLII	45426-0588	45426-1088	45426-1888	45526-0588	45526-1088	45526-1888
Winchester	70 short/long action (hint. BA:21,9 mm)	45426-0524	45426-1024	45426-1824	45526-0524	45526-1024	45526-1824

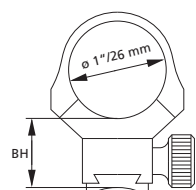

um 10,5 mm verlängerte Ausführung



Fabrikat	Modell	ohne Support			mit Support		
		BH 17,5 mm	BH 22,5 mm	BH 30,5 mm	BH 17,5 mm	BH 22,5 mm	BH 30,5 mm
Anschütz	1780 /1781	45826-052B	45826-102B	45826-182B	45926-052B	45926-102B	45926-182B
Benelli	ARGO	45826-0576	45826-1076	45826-1876	45926-0576	45926-1076	45926-1876
FN Browning	A-Bolt	45826-0520	45826-1020	45826-1820	45926-0520	45926-1020	45926-1820
	A-Bolt III	45826-052T	45826-102T	45826-182T	45926-052T	45926-102T	45926-182T
	BAR	45826-0503	45826-1003	45826-1803	45926-0503	45926-1003	45926-1803
	Maral	45826-052J	45826-102J	45826-182J	45926-052J	45926-102J	45926-182J
Haenel	Jäger 10 (ab Serien-Nr. JX-000921)	45826-052C	45826-102C	45826-182C	45926-052C	45926-102C	45926-182C
	SLB 2000+	45826-052I	45826-102I	45826-182I	45926-052I	45926-102I	45926-182I
H&K	SLB 2000	45826-0508	45826-1008	45826-1808	45926-0508	45926-1008	45926-1808
Howa	1500	45826-0559	45826-1059	45826-1859	45926-0559	45926-1059	45926-1859
Mauser	K 98 (und Nachbauten)	45826-0510	45826-1010	45826-1810	45926-0510	45926-1010	45926-1810
	M 12	45826-052L	45826-102L	45826-182L	45926-052L	45926-102L	45926-182L
Merkel	SR1 Basic	45826-052D	45826-102D	45826-182D	45926-052D	45926-102D	45926-182D
Remington	700 (Gewinde UNS 6-48)	45826-0512	45826-1012	45826-1812	45926-0512	45926-1012	45926-1812
	7400/7600/750	45826-0513	45826-1013	45826-1813	45926-0513	45926-1013	45926-1813
RWS-Röbler	Titan 3 / Titan 6 / Titan α	45826-0592	45826-1092	45826-1892	45926-0592	45926-1092	45926-1892
	Titan 16	45826-052G	45826-102G	45826-182G	45926-052G	45926-102G	45926-182G
Sauer	101	45826-052K	45826-102K	45826-182K	45926-052K	45926-102K	45926-182K
	200	45826-0516	45826-1016	45826-1816	45926-0516	45926-1016	45926-1816
	202	45826-0580	45826-1080	45826-1880	45926-0580	45926-1080	45926-1880
Steyr-Mannlicher	SBS-96 Exp./Pro Hunter/Classic/SM12/CLII	45826-0588	45826-1088	45826-1888	45926-0588	45926-1088	45926-1888
Winchester	70 short/long action (hint. BA:21,9 mm)	45826-0524	45826-1024	45826-1824	45926-0524	45926-1024	45926-1824

Tip-off mounts with bases for bolt action rifles / Montages basculants avec embasses pour carabine à répétition

Aufkippmontagen mit einstellbaren, federnden Gegendruck-Klemmschiebern, 16 mm Prisma und Basen zur Befestigung auf der Hülse.
Die Montagen sind lieferbar in kurzer und verlängerter Ausführung jeweils ohne und mit Support.
Sie erhalten diese wahlweise mit Klemmrings bzw. für verschiedene Zielfernrohrschienen.

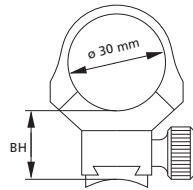

kurze Ausführung



Fabrikat	Modell	ohne Support			mit Support		
		BH 17,5 mm	BH 22,5 mm	BH 30,5 mm	BH 17,5 mm	BH 22,5 mm	BH 30,5 mm
Anschütz	1780 /1781	45430-052B	45430-102B	45430-182B	45530-052B	45530-102B	45530-182B
Benelli	ARGO	45430-0576	45430-1076	45430-1876	45530-0576	45530-1076	45530-1876
FN Browning	A-Bolt	45430-0520	45430-1020	45430-1820	45530-0520	45530-1020	45530-1820
	A-Bolt III	45430-052T	45430-102T	45430-182T	45530-052T	45530-102T	45530-182T
	BAR	45430-0503	45430-1003	45430-1803	45530-0503	45530-1003	45530-1803
	Maral	45430-052J	45430-102J	45430-182J	45530-052J	45530-102J	45530-182J
Haenel	Jäger 10 (ab Serien-Nr. JX-000921)	45430-052C	45430-102C	45430-182C	45530-052C	45530-102C	45530-182C
	SLB 2000+	45430-052I	45430-102I	45430-182I	45530-052I	45530-102I	45530-182I
H&K	SLB 2000	45430-0508	45430-1008	45430-1808	45530-0508	45530-1008	45530-1808
Howa	1500	45430-0559	45430-1059	45430-1859	45530-0559	45530-1059	45530-1859
Mauser	K 98 (und Nachbauten)	45430-0510	45430-1010	45430-1810	45530-0510	45530-1010	45530-1810
	M 12	45430-052L	45430-102L	45430-182L	45530-052L	45530-102L	45530-182L
Merkel	SR1 Basic	45430-052D	45430-102D	45430-182D	45530-052D	45530-102D	45530-182D
Remington	700 (Gewinde UNS 6-48)	45430-0512	45430-1012	45430-1812	45530-0512	45530-1012	45530-1812
	7400/7600/750	45430-0513	45430-1013	45430-1813	45530-0513	45530-1013	45530-1813
RWS-Röbler	Titan 3 / Titan 6 / Titan α	45430-0592	45430-1092	45430-1892	45530-0592	45530-1092	45530-1892
	Titan 16	45430-052G	45430-102G	45430-182G	45530-052G	45530-102G	45530-182G
Sauer	101	45430-052K	45430-102K	45430-182K	45530-052K	45530-102K	45530-182K
	200	45430-0516	45430-1016	45430-1816	45530-0516	45530-1016	45530-1816
	202	45430-0580	45430-1080	45430-1880	45530-0580	45530-1080	45530-1880
Steyr-Mannlicher	SBS-96 Exp./Pro Hunter/Classic/SM12/CLII	45430-0588	45430-1088	45430-1888	45530-0588	45530-1088	45530-1888
Winchester	70 short/long action (hint. BA:21,9 mm)	45430-0524	45430-1024	45430-1824	45530-0524	45530-1024	45530-1824

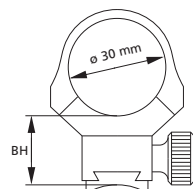

um 10,5 mm verlängerte Ausführung



Fabrikat	Modell	ohne Support			mit Support		
		BH 17,5 mm	BH 22,5 mm	BH 30,5 mm	BH 17,5 mm	BH 22,5 mm	BH 30,5 mm
Anschütz	1780 /1781	45830-052B	45830-102B	45830-182B	45930-052B	45930-102B	45930-182B
Benelli	ARGO	45830-0576	45830-1076	45830-1876	45930-0576	45930-1076	45930-1876
FN Browning	A-Bolt	45830-0520	45830-1020	45830-1820	45930-0520	45930-1020	45930-1820
	A-Bolt III	45830-052T	45830-102T	45830-182T	45930-052T	45930-102T	45930-182T
	BAR	45830-0503	45830-1003	45830-1803	45930-0503	45930-1003	45930-1803
	Maral	45830-052J	45830-102J	45830-182J	45930-052J	45930-102J	45930-182J
Haenel	Jäger 10 (ab Serien-Nr. JX-000921)	45830-052C	45830-102C	45830-182C	45930-052C	45930-102C	45930-182C
	SLB 2000+	45830-052I	45830-102I	45830-182I	45930-052I	45930-102I	45930-182I
H&K	SLB 2000	45830-0508	45830-1008	45830-1808	45930-0508	45930-1008	45930-1808
Howa	1500	45830-0559	45830-1059	45830-1859	45930-0559	45930-1059	45930-1859
Mauser	K 98 (und Nachbauten)	45830-0510	45830-1010	45830-1810	45930-0510	45930-1010	45930-1810
	M 12	45830-052L	45830-102L	45830-182L	45930-052L	45930-102L	45930-182L
Merkel	SR1 Basic	45830-052D	45830-102D	45830-182D	45930-052D	45930-102D	45930-182D
Remington	700 (Gewinde UNS 6-48)	45830-0512	45830-1012	45830-1812	45930-0512	45930-1012	45930-1812
	7400/7600/750	45830-0513	45830-1013	45830-1813	45930-0513	45930-1013	45930-1813
RWS-Röbler	Titan 3 / Titan 6 / Titan α	45830-0592	45830-1092	45830-1892	45930-0592	45930-1092	45930-1892
	Titan 16	45830-052G	45830-102G	45830-182G	45930-052G	45930-102G	45930-182G
Sauer	101	45830-052K	45830-102K	45830-182K	45930-052K	45930-102K	45930-182K
	200	45830-0516	45830-1016	45830-1816	45930-0516	45930-1016	45930-1816
	202	45830-0580	45830-1080	45830-1880	45930-0580	45930-1080	45930-1880
Steyr-Mannlicher	SBS-96 Exp./Pro Hunter/Classic/SM12/CLII	45830-0588	45830-1088	45830-1888	45930-0588	45930-1088	45930-1888
Winchester	70 short/long action (hint. BA:21,9 mm)	45830-0524	45830-1024	45830-1824	45930-0524	45930-1024	45930-1824

AUFKIPPMONTAGEN mit BASEN für Repetierbüchsen

Tip-off mounts with bases for bolt action rifles / Montages basculants avec embasses pour carabine à répétition

Aufkippmontagen mit einstellbaren, federnden Gegendruck-Klemmschiebern, 16 mm Prisma und Basen zur Befestigung auf der Hülse.
Die Montagen sind lieferbar in kurzer und verlängerter Ausführung jeweils ohne und mit Support.
Sie erhalten diese wahlweise mit Klemmrings bzw. für verschiedene Zielfernrohrschienen.

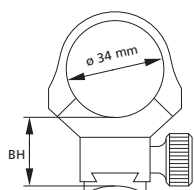

kurze Ausführung



Fabrikat	Modell	ohne Support			mit Support		
		BH 17,5 mm	BH 22,5 mm	BH 30,5 mm	BH 17,5 mm	BH 22,5 mm	BH 30,5 mm
Anschütz	1780 /1781	45434-052B	45434-102B	45434-182B	45534-052B	45534-102B	45534-182B
Benelli	ARGO	45434-0576	45434-1076	45434-1876	45534-0576	45534-1076	45534-1876
FN Browning	A-Bolt	45434-0520	45434-1020	45434-1820	45534-0520	45534-1020	45534-1820
	A-Bolt III	45434-052T	45434-102T	45434-182T	45534-052T	45534-102T	45534-182T
	BAR	45434-0503	45434-1003	45434-1803	45534-0503	45534-1003	45534-1803
	Maral	45434-052J	45434-102J	45434-182J	45534-052J	45534-102J	45534-182J
Haenel	Jäger 10 (ab Serien-Nr. JX-000921)	45434-052C	45434-102C	45434-182C	45534-052C	45534-102C	45534-182C
	SLB 2000+	45434-052I	45434-102I	45434-182I	45534-052I	45534-102I	45534-182I
H&K	SLB 2000	45434-0508	45434-1008	45434-1808	45534-0508	45534-1008	45534-1808
Howa	1500	45434-0559	45434-1059	45434-1859	45534-0559	45534-1059	45534-1859
Mauser	K 98 (und Nachbauten)	45434-0510	45434-1010	45434-1810	45534-0510	45534-1010	45534-1810
	M 12	45434-052L	45434-102L	45434-182L	45534-052L	45534-102L	45534-182L
Merkel	SR1 Basic	45434-052D	45434-102D	45434-182D	45534-052D	45534-102D	45534-182D
Remington	700 (Gewinde UNS 6-48)	45434-0512	45434-1012	45434-1812	45534-0512	45534-1012	45534-1812
	7400/7600/750	45434-0513	45434-1013	45434-1813	45534-0513	45534-1013	45534-1813
RWS-Röbler	Titan 3 / Titan 6 / Titan α	45434-0592	45434-1092	45434-1892	45534-0592	45534-1092	45534-1892
	Titan 16	45434-052G	45434-102G	45434-182G	45534-052G	45534-102G	45534-182G
Sauer	101	45434-052K	45434-102K	45434-182K	45534-052K	45534-102K	45534-182K
	200	45434-0516	45434-1016	45434-1816	45534-0516	45534-1016	45534-1816
	202	45434-0580	45434-1080	45434-1880	45534-0580	45534-1080	45534-1880
Steyr-Mannlicher	SBS-96 Exp./Pro Hunter/Classic/SM12/CLII	45434-0588	45434-1088	45434-1888	45534-0588	45534-1088	45534-1888
Winchester	70 short/long action (hint. BA:21,9 mm)	45434-0524	45434-1024	45434-1824	45534-0524	45534-1024	45534-1824

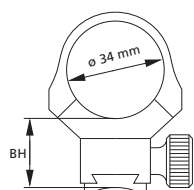

um 10,5 mm verlängerte Ausführung



Fabrikat	Modell	ohne Support			mit Support		
		BH 17,5 mm	BH 22,5 mm	BH 30,5 mm	BH 17,5 mm	BH 22,5 mm	BH 30,5 mm
Anschütz	1780 /1781	45834-052B	45834-102B	45834-182B	45934-052B	45934-102B	45934-182B
Benelli	ARGO	45834-0576	45834-1076	45834-1876	45934-0576	45934-1076	45934-1876
FN Browning	A-Bolt	45834-0520	45834-1020	45834-1820	45934-0520	45934-1020	45934-1820
	A-Bolt III	45834-052T	45834-102T	45834-182T	45934-052T	45934-102T	45934-182T
	BAR	45834-0503	45834-1003	45834-1803	45934-0503	45934-1003	45934-1803
	Maral	45834-052J	45834-102J	45834-182J	45934-052J	45934-102J	45934-182J
Haenel	Jäger 10 (ab Serien-Nr. JX-000921)	45834-052C	45834-102C	45834-182C	45934-052C	45934-102C	45934-182C
	SLB 2000+	45834-052I	45834-102I	45834-182I	45934-052I	45934-102I	45934-182I
H&K	SLB 2000	45834-0508	45834-1008	45834-1808	45934-0508	45934-1008	45934-1808
Howa	1500	45834-0559	45834-1059	45834-1859	45934-0559	45934-1059	45934-1859
Mauser	K 98 (und Nachbauten)	45834-0510	45834-1010	45834-1810	45934-0510	45934-1010	45934-1810
	M 12	45834-052L	45834-102L	45834-182L	45934-052L	45934-102L	45934-182L
Merkel	SR1 Basic	45834-052D	45834-102D	45834-182D	45934-052D	45934-102D	45934-182D
Remington	700 (Gewinde UNS 6-48)	45834-0512	45834-1012	45834-1812	45934-0512	45934-1012	45934-1812
	7400/7600/750	45834-0513	45834-1013	45834-1813	45934-0513	45934-1013	45934-1813
RWS-Röbler	Titan 3 / Titan 6 / Titan α	45834-0592	45834-1092	45834-1892	45934-0592	45934-1092	45934-1892
	Titan 16	45834-052G	45834-102G	45834-182G	45934-052G	45934-102G	45934-182G
Sauer	101	45834-052K	45834-102K	45834-182K	45934-052K	45934-102K	45934-182K
	200	45834-0516	45834-1016	45834-1816	45934-0516	45934-1016	45934-1816
	202	45834-0580	45834-1080	45834-1880	45934-0580	45934-1080	45934-1880
Steyr-Mannlicher	SBS-96 Exp./Pro Hunter/Classic/SM12/CLII	45834-0588	45834-1088	45834-1888	45934-0588	45934-1088	45934-1888
Winchester	70 short/long action (hint. BA:21,9 mm)	45834-0524	45834-1024	45834-1824	45934-0524	45934-1024	45934-1824

ERA AUFKIPPMONTAGEN mit BASEN für Repetierbüchsen

Tip-off mounts with bases for bolt action rifles / Montages basculants avec embasses pour carabine à répétition

Aufkippmontagen mit einstellbaren, federnden Gegendruck-Klemmschiebern, 16 mm Prisma und Basen zur Befestigung auf der Hülse.
Die Montagen sind lieferbar in kurzer und verlängerter Ausführung jeweils ohne und mit Support.
Sie erhalten diese wahlweise mit Klemmrings bzw. für verschiedene Zielfernrohrschienen.

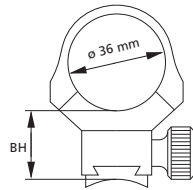

kurze Ausführung



Fabrikat	Modell	ohne Support			mit Support		
		BH 17,5 mm	BH 22,5 mm	BH 30,5 mm	BH 17,5 mm	BH 22,5 mm	BH 30,5 mm
Anschütz	1780 /1781	45436-052B	45436-102B	45436-182B	45536-052B	45536-102B	45536-182B
Benelli	ARGO	45436-0576	45436-1076	45436-1876	45536-0576	45536-1076	45536-1876
FN Browning	A-Bolt	45436-0520	45436-1020	45436-1820	45536-0520	45536-1020	45536-1820
	A-Bolt III	45436-052T	45436-102T	45436-182T	45536-052T	45536-102T	45536-182T
	BAR	45436-0503	45436-1003	45436-1803	45536-0503	45536-1003	45536-1803
	Maral	45436-052J	45436-102J	45436-182J	45536-052J	45536-102J	45536-182J
Haenel	Jäger 10 (ab Serien-Nr. JX-000921)	45436-052C	45436-102C	45436-182C	45536-052C	45536-102C	45536-182C
	SLB 2000+	45436-052I	45436-102I	45436-182I	45536-052I	45536-102I	45536-182I
H&K	SLB 2000	45436-0508	45436-1008	45436-1808	45536-0508	45536-1008	45536-1808
Howa	1500	45436-0559	45436-1059	45436-1859	45536-0559	45536-1059	45536-1859
Mauser	K 98 (und Nachbauten)	45436-0510	45436-1010	45436-1810	45536-0510	45536-1010	45536-1810
	M 12	45436-052L	45436-102L	45436-182L	45536-052L	45536-102L	45536-182L
Merkel	SR1 Basic	45436-052D	45436-102D	45436-182D	45536-052D	45536-102D	45536-182D
Remington	700 (Gewinde UNS 6-48)	45436-0512	45436-1012	45436-1812	45536-0512	45536-1012	45536-1812
	7400/7600/750	45436-0513	45436-1013	45436-1813	45536-0513	45536-1013	45536-1813
RWS-Röbler	Titan 3 / Titan 6 / Titan α	45436-0592	45436-1092	45436-1892	45536-0592	45536-1092	45536-1892
	Titan 16	45436-052G	45436-102G	45436-182G	45536-052G	45536-102G	45536-182G
Sauer	101	45436-052K	45436-102K	45436-182K	45536-052K	45536-102K	45536-182K
	200	45436-0516	45436-1016	45436-1816	45536-0516	45536-1016	45536-1816
	202	45436-0580	45436-1080	45436-1880	45536-0580	45536-1080	45536-1880
Steyr-Mannlicher	SBS-96 Exp./Pro Hunter/Classic/SM12/CLII	45436-0588	45436-1088	45436-1888	45536-0588	45536-1088	45536-1888
Winchester	70 short/long action (hint. BA:21,9 mm)	45436-0524	45436-1024	45436-1824	45536-0524	45536-1024	45536-1824

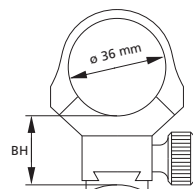

um 10,5 mm verlängerte Ausführung



Fabrikat	Modell	ohne Support			mit Support		
		BH 17,5 mm	BH 22,5 mm	BH 30,5 mm	BH 17,5 mm	BH 22,5 mm	BH 30,5 mm
Anschütz	1780 /1781	45836-052B	45836-102B	45836-182B	45936-052B	45936-102B	45936-182B
Benelli	ARGO	45836-0576	45836-1076	45836-1876	45936-0576	45936-1076	45936-1876
FN Browning	A-Bolt	45836-0520	45836-1020	45836-1820	45936-0520	45936-1020	45936-1820
	A-Bolt III	45836-052T	45836-102T	45836-182T	45936-052T	45936-102T	45936-182T
	BAR	45836-0503	45836-1003	45836-1803	45936-0503	45936-1003	45936-1803
	Maral	45836-052J	45836-102J	45836-182J	45936-052J	45936-102J	45936-182J
Haenel	Jäger 10 (ab Serien-Nr. JX-000921)	45836-052C	45836-102C	45836-182C	45936-052C	45936-102C	45936-182C
	SLB 2000+	45836-052I	45836-102I	45836-182I	45936-052I	45936-102I	45936-182I
H&K	SLB 2000	45836-0508	45836-1008	45836-1808	45936-0508	45936-1008	45936-1808
Howa	1500	45836-0559	45836-1059	45836-1859	45936-0559	45936-1059	45936-1859
Mauser	K 98 (und Nachbauten)	45836-0510	45836-1010	45836-1810	45936-0510	45936-1010	45936-1810
	M 12	45836-052L	45836-102L	45836-182L	45936-052L	45936-102L	45936-182L
Merkel	SR1 Basic	45836-052D	45836-102D	45836-182D	45936-052D	45936-102D	45936-182D
Remington	700 (Gewinde UNS 6-48)	45836-0512	45836-1012	45836-1812	45936-0512	45936-1012	45936-1812
	7400/7600/750	45836-0513	45836-1013	45836-1813	45936-0513	45936-1013	45936-1813
RWS-Röbler	Titan 3 / Titan 6 / Titan α	45836-0592	45836-1092	45836-1892	45936-0592	45936-1092	45936-1892
	Titan 16	45836-052G	45836-102G	45836-182G	45936-052G	45936-102G	45936-182G
Sauer	101	45836-052K	45836-102K	45836-182K	45936-052K	45936-102K	45936-182K
	200	45836-0516	45836-1016	45836-1816	45936-0516	45936-1016	45936-1816
	202	45836-0580	45836-1080	45836-1880	45936-0580	45936-1080	45936-1880
Steyr-Mannlicher	SBS-96 Exp./Pro Hunter/Classic/SM12/CLII	45836-0588	45836-1088	45836-1888	45936-0588	45936-1088	45936-1888
Winchester	70 short/long action (hint. BA:21,9 mm)	45836-0524	45836-1024	45836-1824	45936-0524	45936-1024	45936-1824

AUFKIPPMONTAGEN mit BASEN für Repetierbüchsen

Tip-off mounts with bases for bolt action rifles / Montages basculants avec embasses pour carabine à répétition

Aufkippmontagen mit einstellbaren, federnden Gegendruck-Klemmschiebern, 16 mm Prisma und Basen zur Befestigung auf der Hülse.
Die Montagen sind lieferbar in kurzer und verlängerter Ausführung jeweils ohne und mit Support.
Sie erhalten diese wahlweise mit Klemmrings bzw. für verschiedene Zielfernrohrschienen.

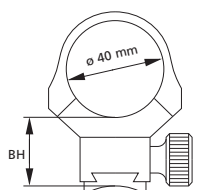

kurze Ausführung



ohne Support

mit Support

Fabrikat	Modell	ohne Support		mit Support	
		BH 17,5 mm	BH 22,5 mm	BH 17,5 mm	BH 22,5 mm
Anschütz	1780 /1781	45440-052B	45440-102B	45540-052B	45540-102B
Benelli	ARGO	45440-0576	45440-1076	45540-0576	45540-1076
FN Browning	A-Bolt	45440-0520	45440-1020	45540-0520	45540-1020
	A-Bolt III	45440-052T	45440-102T	45540-052T	45540-102T
	BAR	45440-0503	45440-1003	45540-0503	45540-1003
	Maral	45440-052J	45440-102J	45540-052J	45540-102J
Haenel	Jäger 10 (ab Serien-Nr. JX-000921)	45440-052C	45440-102C	45540-052C	45540-102C
	SLB 2000+	45440-052I	45440-102I	45540-052I	45540-102I
H&K	SLB 2000	45440-0508	45440-1008	45540-0508	45540-1008
Howa	1500	45440-0559	45440-1059	45540-0559	45540-1059
Mauser	K 98 (und Nachbauten)	45440-0510	45440-1010	45540-0510	45540-1010
	M 12	45440-052L	45440-102L	45540-052L	45540-102L
Merkel	SR1 Basic	45440-052D	45440-102D	45540-052D	45540-102D
Remington	700 (Gewinde UNS 6-48)	45440-0512	45440-1012	45540-0512	45540-1012
	7400/7600/750	45440-0513	45440-1013	45540-0513	45540-1013
RWS-Röbler	Titan 3 / Titan 6 / Titan α	45440-0592	45440-1092	45540-0592	45540-1092
	Titan 16	45440-052G	45440-102G	45540-052G	45540-102G
Sauer	101	45440-052K	45440-102K	45540-052K	45540-102K
	200	45440-0516	45440-1016	45540-0516	45540-1016
	202	45440-0580	45440-1080	45540-0580	45540-1080
Steyr-Mannlicher	SBS-96 Exp./Pro Hunter/Classic/SM12/CLII	45440-0588	45440-1088	45540-0588	45540-1088
Winchester	70 short/long action (hint. BA:21,9 mm)	45440-0524	45440-1024	45540-0524	45540-1024

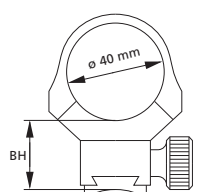

um 10,5 mm verlängerte Ausführung



ohne Support

mit Support

Fabrikat	Modell	ohne Support		mit Support	
		BH 17,5 mm	BH 22,5 mm	BH 17,5 mm	BH 22,5 mm
Anschütz	1780 /1781	45840-052B	45840-102B	45940-052B	45940-102B
Benelli	ARGO	45840-0576	45840-1076	45940-0576	45940-1076
FN Browning	A-Bolt	45840-0520	45840-1020	45940-0520	45940-1020
	A-Bolt III	45840-052T	45840-102T	45940-052T	45940-102T
	BAR	45840-0503	45840-1003	45940-0503	45940-1003
	Maral	45840-052J	45840-102J	45940-052J	45940-102J
Haenel	Jäger 10 (ab Serien-Nr. JX-000921)	45840-052C	45840-102C	45940-052C	45940-102C
	SLB 2000+	45840-052I	45840-102I	45940-052I	45940-102I
H&K	SLB 2000	45840-0508	45840-1008	45940-0508	45940-1008
Howa	1500	45840-0559	45840-1059	45940-0559	45940-1059
Mauser	K 98 (und Nachbauten)	45840-0510	45840-1010	45940-0510	45940-1010
	M 12	45840-052L	45840-102L	45940-052L	45940-102L
Merkel	SR1 Basic	45840-052D	45840-102D	45940-052D	45940-102D
Remington	700 (Gewinde UNS 6-48)	45840-0512	45840-1012	45940-0512	45940-1012
	7400/7600/750	45840-0513	45840-1013	45940-0513	45940-1013
RWS-Röbler	Titan 3 / Titan 6 / Titan α	45840-0592	45840-1092	45940-0592	45940-1092
	Titan 16	45840-052G	45840-102G	45940-052G	45940-102G
Sauer	101	45840-052K	45840-102K	45940-052K	45940-102K
	200	45840-0516	45840-1016	45940-0516	45940-1016
	202	45840-0580	45840-1080	45940-0580	45940-1080
Steyr-Mannlicher	SBS-96 Exp./Pro Hunter/Classic/SM12/CLII	45840-0588	45840-1088	45940-0588	45940-1088
Winchester	70 short/long action (hint. BA:21,9 mm)	45840-0524	45840-1024	45940-0524	45940-1024

ERA AUFKIPPMONTAGEN mit BASEN für Repetierbüchsen

Tip-off mounts with bases for bolt action rifles / Montages basculants avec embasses pour carabine à répétition

Aufkippmontagen mit einstellbaren, federnden Gegendruck-Klemmschiebern, 16 mm Prisma und Basen zur Befestigung auf der Hülse.
Die Montagen sind lieferbar in kurzer und verlängerter Ausführung jeweils ohne und mit Support.
Sie erhalten diese wahlweise mit Klemmrings bzw. für verschiedene Zielfernrohrschienen.

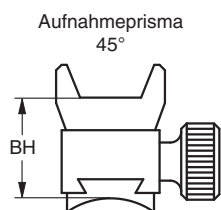

Fabrikat	Modell	kurze Ausführung, BH 18,5		um 10,5 mm verlängerte Ausführung BH 18,5	
		ohne Support	mit Support	ohne Support	mit Support
Anschütz	1780 /1781	45445-052B	45545-052B	45845-052B	45945-052B
Benelli	ARGO	45445-0576	45545-0576	45845-0576	45945-0576
FN Browning	A-Bolt	45445-0520	45545-0520	45845-0520	45945-0520
	A-Bolt III	45445-052T	45545-052T	45845-052T	45945-052T
	BAR	45445-0503	45545-0503	45845-0503	45945-0503
	Maral	45445-052J	45545-052J	45845-052J	45945-052J
Haenel	Jäger 10 (ab Serien-Nr. JX-000921)	45445-052C	45545-052C	45845-052C	45945-052C
	SLB 2000+	45445-052I	45545-052I	45845-052I	45945-052I
H&K	SLB 2000	45445-0508	45545-0508	45845-0508	45945-0508
Howa	1500	45445-0559	45545-0559	45845-0559	45945-0559
Mauser	K 98 (und Nachbauten)	45445-0510	45545-0510	45845-0510	45945-0510
	M 12	45445-052L	45545-052L	45845-052L	45945-052L
Merkel	SR1 Basic	45445-052D	45545-052D	45845-052D	45945-052D
Remington	700 (Gewinde UNS 6-48)	45445-0512	45545-0512	45845-0512	45945-0512
	7400/7600/750	45445-0513	45545-0513	45845-0513	45945-0513
RWS-Röbler	Titan 3 / Titan 6 / Titan α	45445-0592	45545-0592	45845-0592	45945-0592
	Titan 16	45445-052G	45545-052G	45845-052G	45945-052G
Sauer	101	45445-052K	45545-052K	45845-052K	45945-052K
	200	45445-0516	45545-0516	45845-0516	45945-0516
	202	45445-0580	45545-0580	45845-0580	45945-0580
Steyr-Mannliche	SBS-96 Exp./Pro Hunter/Classic/SM12/CLII	45445-0588	45545-0588	45845-0588	45945-0588
Winchester	70 short/long action (hint. BA:21,9 mm)	45445-0524	45545-0524	45845-0524	45945-0524

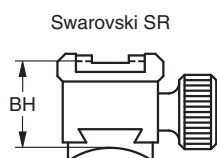

Fabrikat	Modell	kurze Ausführung, BH 17,5		um 10,5 mm verlängerte Ausführung BH 17,5	
		ohne Support	mit Support	ohne Support	mit Support
Anschütz	1780 /1781	45453-052B	45553-052B	45853-052B	45953-052B
Benelli	ARGO	45453-0576	45553-0576	45853-0576	45953-0576
FN Browning	A-Bolt	45453-0520	45553-0520	45853-0520	45953-0520
	A-Bolt III	45453-052T	45553-052T	45853-052T	45953-052T
	BAR	45453-0503	45553-0503	45853-0503	45953-0503
	Maral	45453-052J	45553-052J	45853-052J	45953-052J
Haenel	Jäger 10 (ab Serien-Nr. JX-000921)	45453-052C	45553-052C	45853-052C	45953-052C
	SLB 2000+	45453-052I	45553-052I	45853-052I	45953-052I
H&K	SLB 2000	45453-0508	45553-0508	45853-0508	45953-0508
Howa	1500	45453-0559	45553-0559	45853-0559	45953-0559
Mauser	K 98 (und Nachbauten)	45453-0510	45553-0510	45853-0510	45953-0510
	M 12	45453-052L	45553-052L	45853-052L	45953-052L
Merkel	SR1 Basic	45453-052D	45553-052D	45853-052D	45953-052D
Remington	700 (Gewinde UNS 6-48)	45453-0512	45553-0512	45853-0512	45953-0512
	7400/7600/750	45453-0513	45553-0513	45853-0513	45953-0513
RWS-Röbler	Titan 3 / Titan 6 / Titan α	45453-0592	45553-0592	45853-0592	45953-0592
	Titan 16	45453-052G	45553-052G	45853-052G	45953-052G
Sauer	101	45453-052K	45553-052K	45853-052K	45953-052K
	200	45453-0516	45553-0516	45853-0516	45953-0516
	202	45453-0580	45553-0580	45853-0580	45953-0580
Steyr-Mannliche	SBS-96 Exp./Pro Hunter/Classic/SM12/CLII	45453-0588	45553-0588	45853-0588	45953-0588
Winchester	70 short/long action (hint. BA:21,9 mm)	45453-0524	45553-0524	45853-0524	45953-0524

AUFKIPPMONTAGEN mit BASEN für Repetierbüchsen

Tip-off mounts with bases for bolt action rifles / Montages basculants avec embasses pour carabine à répétition

Aufkippmontagen mit einstellbaren, federnden Gegendruck-Klemmschiebern, 16 mm Prisma und Basen zur Befestigung auf der Hülse.
Die Montagen sind lieferbar in kurzer und verlängerter Ausführung jeweils ohne und mit Support.
Sie erhalten diese wahlweise mit Klemmrings bzw. für verschiedene Zielfernrohrschienen.

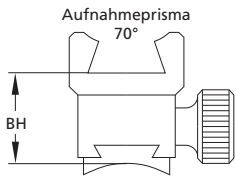

kurze Ausführung

um 10,5 mm verlängerte Ausführung

ohne Support		mit Support		ohne Support		mit Support	
BH 16,5 mm	BH 21,5 mm	BH 16,5 mm	BH 21,5 mm	BH 16,5 mm	BH 21,5 mm	BH 16,5 mm	BH 21,5 mm
45470-042B	45470-092B	45570-042B	45570-092B	45870-042B	45870-092B	45970-042B	45970-092B
45470-0476	45470-0976	45570-0476	45570-0976	45870-0476	45870-0976	45970-0476	45970-0976
45470-0420	45470-0920	45570-0420	45570-0920	45870-0420	45870-0920	45970-0420	45970-0920
45470-042T	45470-092T	45570-042T	45570-092T	45870-042T	45870-092T	45970-042T	45970-092T
45470-0403	45470-0903	45570-0403	45570-0903	45870-0403	45870-0903	45970-0403	45970-0903
45470-042J	45470-092J	45570-042J	45570-092J	45870-042J	45870-092J	45970-042J	45970-092J
45470-042C	45470-092C	45570-042C	45570-092C	45870-042C	45870-092C	45970-042C	45970-092C
45470-042I	45470-092I	45570-042I	45570-092I	45870-042I	45870-092I	45970-042I	45970-092I
45470-0408	45470-0908	45570-0408	45570-0908	45870-0408	45870-0908	45970-0408	45970-0908
45470-0459	45470-0959	45570-0459	45570-0959	45870-0459	45870-0959	45970-0459	45970-0959
45470-0410	45470-0910	45570-0410	45570-0910	45870-0410	45870-0910	45970-0410	45970-0910
45470-042L	45470-092L	45570-042L	45570-092L	45870-042L	45870-092L	45970-042L	45970-092L
45470-042D	45470-092D	45570-042D	45570-092D	45870-042D	45870-092D	45970-042D	45970-092D
45470-0412	45470-0912	45570-0412	45570-0912	45870-0412	45870-0912	45970-0412	45970-0912
45470-0413	45470-0913	45570-0413	45570-0913	45870-0413	45870-0913	45970-0413	45970-0913
45470-0492	45470-0992	45570-0492	45570-0992	45870-0492	45870-0992	45970-0492	45970-0992
45470-042G	45470-092G	45570-042G	45570-092G	45870-042G	45870-092G	45970-042G	45970-092G
45470-042K	45470-092K	45570-042K	45570-092K	45870-042K	45870-092K	45970-042K	45970-092K
45470-0416	45470-0916	45570-0416	45570-0916	45870-0416	45870-0916	45970-0416	45970-0916
45470-0480	45470-0980	45570-0480	45570-0980	45870-0480	45870-0980	45970-0480	45970-0980
45470-0488	45470-0988	45570-0488	45570-0988	45870-0488	45870-0988	45970-0488	45970-0988
45470-0424	45470-0924	45570-0424	45570-0924	45870-0424	45870-0924	45970-0424	45970-0924

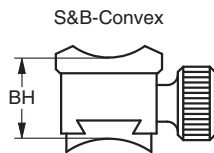

kurze Ausführung, BH 15,5

um 10,5 mm verlängerte Ausführung BH 15,5

ohne Support		mit Support		ohne Support		mit Support	
45467-052B	45567-052B	45867-052B	45967-052B	45867-052B	45967-052B	45867-052B	45967-052B
45467-0576	45567-0576	45867-0576	45967-0576	45867-0576	45967-0576	45867-0576	45967-0576
45467-0520	45567-0520	45867-0520	45967-0520	45867-0520	45967-0520	45867-0520	45967-0520
45467-052T	45567-052T	45867-052T	45967-052T	45867-052T	45967-052T	45867-052T	45967-052T
45467-0503	45567-0503	45867-0503	45967-0503	45867-0503	45967-0503	45867-0503	45967-0503
45467-052J	45567-052J	45867-052J	45967-052J	45867-052J	45967-052J	45867-052J	45967-052J
45467-052C	45567-052C	45867-052C	45967-052C	45867-052C	45967-052C	45867-052C	45967-052C
45467-052I	45567-052I	45867-052I	45967-052I	45867-052I	45967-052I	45867-052I	45967-052I
45467-0508	45567-0508	45867-0508	45967-0508	45867-0508	45967-0508	45867-0508	45967-0508
45467-0559	45567-0559	45867-0559	45967-0559	45867-0559	45967-0559	45867-0559	45967-0559
45467-0510	45567-0510	45867-0510	45967-0510	45867-0510	45967-0510	45867-0510	45967-0510
45467-052L	45567-052L	45867-052L	45967-052L	45867-052L	45967-052L	45867-052L	45967-052L
45467-052D	45567-052D	45867-052D	45967-052D	45867-052D	45967-052D	45867-052D	45967-052D
45467-0512	45567-0512	45867-0512	45967-0512	45867-0512	45967-0512	45867-0512	45967-0512
45467-0513	45567-0513	45867-0513	45967-0513	45867-0513	45967-0513	45867-0513	45967-0513
45467-0592	45567-0592	45867-0592	45967-0592	45867-0592	45967-0592	45867-0592	45967-0592
45467-052G	45567-052G	45867-052G	45967-052G	45867-052G	45967-052G	45867-052G	45967-052G
45467-052K	45567-052K	45867-052K	45967-052K	45867-052K	45967-052K	45867-052K	45967-052K
45467-0516	45567-0516	45867-0516	45967-0516	45867-0516	45967-0516	45867-0516	45967-0516
45467-0580	45567-0580	45867-0580	45967-0580	45867-0580	45967-0580	45867-0580	45967-0580
45467-0588	45567-0588	45867-0588	45967-0588	45867-0588	45967-0588	45867-0588	45967-0588
45467-0524	45567-0524	45867-0524	45967-0524	45867-0524	45967-0524	45867-0524	45967-0524

Bases for tip-off mounts for 16 mm dovetail / Embasses pour montages basculants avec 16 mm prisme

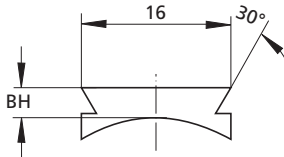

Basen für Aufkippmontagen mit 16 mm Prisma;
Vorderbasen BH 3,5 mm;
Höhe der Hinterbasen ist modellbezogen.

Fabrikat	Modell	Vorderbasen	Hinterbasen
Anschütz	1780 /1781	48005-002B	48010-002B
Benelli	ARGO	48005-0076	48010-0076
FN Browning	A-Bolt	48005-0020	48010-0020
	A-Bolt III	48005-002T	48010-002T
	BAR	48005-0003	48010-0003
	Maral	48005-002J	48010-002J
Haenel	Jäger 10 (ab Serien-Nr. JX-000921)	48005-002C	48010-002C
	SLB 2000+	48005-002I	48010-002I
H&K	SLB 2000	48005-0008	48010-0008
Howa	1500	48005-0059	48010-0059
Mauser	K 98 (und Nachbauten)	48005-0010	48010-0010
	M 12	48005-002L	48010-002L
Merkel	SR1 Basic	48005-002D	48010-002D
	700 (Gewinde UNS 6-48)	48005-0012	48010-0012
Remington	7400/7600/750	48005-0013	48010-0013
	RWS-Rößler	Titan 3 / Titan 6 / Titan α	48005-0092
Sauer	Titan 16	48005-002G	48010-002G
	101	48005-002K	48010-002K
	200	48005-0016	48010-0016
Steyr-Mannliche	202	48005-0080	48010-0080
	SBS-96 Exp./Pro Hunter/Classic/SM12/CLII	48005-0088	48010-0088
Winchester	70 short/long action (hint. BA:21,9 mm)	48005-0024	48010-0024



Rings and dovetail attachments / Anneaux et prismes

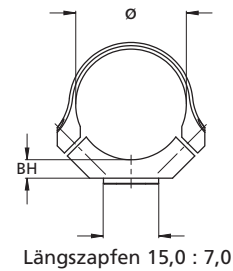
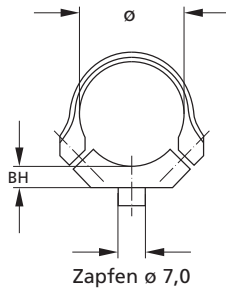

	BH 5,0 mm	BH 10,0 mm	BH 18,0 mm
ø 1"/26 mm	49026-0500	49026-1000	49026-1800
ø 30 mm	49030-0500	49030-1000	49030-1800
ø 34 mm	49034-0500	49034-1000	49034-1800
ø 36 mm	49036-0500	49036-1000	49036-1800
ø 40 mm	49040-0500	49040-1000	

	BH 5,0 mm	BH 10,0 mm	BH 12,0 mm
ø 1"/26 mm	49026-051U	49026-101U	
ø 30 mm	49030-051U	49030-101U	
ø 34 mm	49034-051U		49034-121U
ø 36 mm	49036-051U	49036-101U	
ø 40 mm	49040-051U	49040-101U	

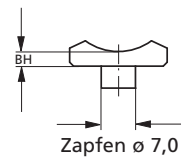
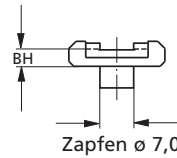
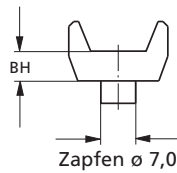
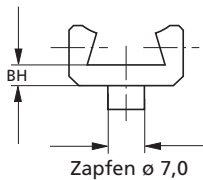

BH	70°	BH	45°	BH	Swarovski SR vorne	BH	Swarovski SR hinten	BH	S&B-Convex
4,0	49070-0400	6,0	49045-0600	5,0	49053-0500		49053-0501	3,0	49067-0300
9,0	49070-0900								

PRISMENSCHIENEN

Rails / Rails



Prismenschiene mit 11 mm Prismenbreite, für Savage 24 V.

47400-1011



Prismenschiene mit 11 mm Prismenbreite, für Savage BBF 24 / 1, Laufdurchmesser 1/2".

47400-2011



Prismenschiene mit 11 mm Prismenbreite, für Ruger 10 / 22 und Savage 24 V.

47400-3011



Prismenschiene mit 11 mm Prismenbreite, für Marlin 39 A.

47400-4011



Prismenschiene mit 11 mm Prismenbreite, für Marlin 336 / 444CL / 94 / Nr. 9.

47400-5011



Prismenschiene mit 16 mm Prismenbreite, für Marlin 336 / 444CL / 94 / Nr. 9.

47400-5016

Tip-off mounts for Merkel / Montages basculants pour Merkel

Aufkippmontagen mit seitlichen Polyformhebeln, passend für Merkel KR1, B3 und B4; gefertigt aus hochfestem Aluminium und schwarz eloxiert. Die Montagen sind mit zwei federnden Klemmbacken, einem Rückstoßstollen und unseren bewährten Polyformhebeln ausgestattet.

Eine parallele Endstellung der Hebel ist in jeder Lage möglich.

Eine Sicherungsschraube verhindert zuverlässig den Verlust der Hebel.

Tip-off mounts with lateral polyform levers for Merkel KR1, B3 and B4; made from high grade aluminum with black anodizing. The mounts are equipped with two clamps, a recoil lug and our approved polyform levers. A parallel final position of the levers can be chosen freely. A safety screw protects the levers from loss.



ø 1"/26 mm	BH [mm]	ø 30 mm	BH [mm]	ø 34 mm	BH [mm]
43526-051U	14,5	43530-051U	14,5	43534-051U	14,5
43526-101U	19,5	43530-101U	19,5	43534-121U	21,5
ø 36 mm	BH [mm]	ø 40 mm	BH [mm]		
43536-051U	14,5	43540-051U	14,5		
43536-101U	19,5	43540-101U	19,5		



70°	BH [mm]
43570-001U	9,5
45°	BH [mm]
43545-001U	9,5
Swarovski SR	BH [mm]
43553-001U	10,0
S&B-Convex	BH [mm]
43567-001U	10,0



Weaver-Aufsatz	BH [mm]
43557-001U	16,5

Scope rings with UNIVERSAL-interface / Anneaux avec jonction d'interface

Klemmringe zur Befestigung am Mittelrohr oder Objektiv, welche mit unserer UNIVERSAL-Schnittstelle ausgerüstet sind, die sich im militärisch-taktischen Bereich bereits bestens bewährt hat. Sie dient zum Anbau von Picatinny-Schienen in diversen Längen und speziellen Aufnahmeplatten, die den sicheren und platzsparenden Anbau von optischen Zusatzgeräten und diverserem Zubehör ermöglichen.

Sie erhalten unsere Ringe mit UNIVERSAL-Schnittstelle in der Ausführung für Klemmung am Mittelrohr oder Objektiv: Die Ringe für Mittelrohr sind beidseitig getrennt, die für Objektivklemmung verfügen über eine einseitige Trennung. Bei Gläsern mit Schiene am Mittelrohr können jedoch nur Objektivringe verwendet werden.

Die Ringbreite beträgt jeweils 18 mm. Die vorhandene Bauhöhe von 3 mm kann im Bedarfsfall durch den Einsatz von Spacern erhöht werden. Bei der Montage am Zielfernrohr ist die radiale Position frei wählbar. Alle Ringe sind aus hochfestem Aluminium gefertigt und harteloxiert nach Mil-Spec. Typ III mattschwarz.

Aluminum scope rings with UNIVERSAL-interface to be fixed to the objective or middle tube of a scope. The interface on top of each ring has proven itself in the military / tactical field and allows the installation of different Picatinny rails and adapters for a secure and space-saving use of optical devices and accessories.

Rings are available in two different versions to be fixed either to the objective or to the middle tube of your scope. The middle tube rings are half split (on both sides), the objective rings are split only on one side. Scopes with a rail on the middle tube require the use of the objective ring. All rings are 18 mm wide and have a height of 3 mm. Spacers for height adjustment are available.



Ø 1"/26 mm	03680-5726	Ø 48 mm	03680-5748
Ø 30 mm	03680-5730	Ø 56 mm	03680-5756
Ø 34 mm	03680-5734	Ø 57 mm	03680-5757
Ø 36 mm	03680-5736	Ø 62 mm	03680-5762

PICATINNY-/ DOCTER sight Aufsätze

Top bases for Picatinny / DOCTER sights / Adapateurs pour Picatinny / DOCTER sights

Diese Aufsätze passen auf unsere UNIVERSAL-Schnittstelle und ermöglichen das Anbringen von Rotpunktvisieren und taktischem Zubehör. Torxschrauben gehören zum Lieferumfang.

These top bases are built to attach to our UNIVERSAL-interface. They allow the use of red dot sights and tactical accessories. Torx screws are included.



Picatinny-Aufsatz, Länge 35 mm, BH 8,0 mm
T0903-0008



Picatinny-Aufsatz, Länge 55 mm, BH 8,0 mm
T0905-0008



Picatinny-Aufsatz, Länge 85 mm, BH 13,0 mm
T0908-0013



Docter-Aufsatz, BH 5,0 mm
T0920-0005



Spacer BH 5,0 mm
T0990-0005



Spacer BH 10,0 mm
T0990-0010

One piece scope mounts for Picatinny / Montages pour Picatinny



Diese für den präzisen Schuss speziell auf lange Distanzen geeignete einteilige Montage aus hochfestem Aluminium wird aus dem Vollen gefertigt.

Die robuste Montage passend für Picatinny-Profil ist lieferbar **ohne** und **mit Vorneigung (20 MOA)**.

Die Ringbreite beträgt 20 mm. Die Klemmung erfolgt über einen seitlichen, federbelasteten Klemmbacken und Dreikantmuttern.

Ein passender Schlüssel gehört zum Lieferumfang.

BH (mm)	20 MOA	ø 1"/26 mm	ø 30 mm	ø 34 mm
15,0 mm	mit/with	57026-0020	57030-0020	57034-0020
15,0 mm	ohne/without	57026-0000	57030-0000	57034-0000

Tactical scope rings with triangular nut / Montages basculants avec boulons triangulaire pour Picatinny/Weaver rails



Die PSG-Aufklippmontage wurde speziell für Präzisionsschützen auf lange Distanzen entwickelt. Sie ist stabil, rückstossicher und formschön; erhältlich ist sie in den ø 1"/26 mm, ø 30 mm, ø 34 mm, ø 36 mm und ø 40 mm jeweils in unterschiedlichen Bauhöhen. Schlüssel für die Dreikantmutter wird mitgeliefert.

BH	ø 1"/26 mm	ø 30 mm	ø 34 mm	ø 36 mm	ø 40 mm
6,0	57026-0601	57030-0601	57034-0601		
7,0				57036-0701	
8,0					57040-0801
9,5	57026-0951	57030-0951	57034-0951	57036-0951	
12,0		57030-1201	57034-1201	57036-1201	57040-1201
14,0	57026-1401	57030-1401	57034-1401	57036-1401	
19,0	57026-1901	57030-1901	57034-1901	57036-1901	
22,0	57026-2201	57030-2201	57034-2201		

Tactical scope rings with polyform lever / Montages basculants avec Leviers pour Picatinny/Weaver rails



Diese zweiteilige Aufklippmontage mit praktischen Polyform-Klemmhebeln wurde entwickelt, um ohne Hilfsmittel einen festen und sicheren Sitz auf Weaver- bzw. Picatinny-Prismen zu gewährleisten. Es ist außerdem möglich, die gewünschte Endstellung der Hebel durch zwanzig verschiedene Wahlmöglichkeiten zu bestimmen. Eine Parallelstellung der Hebel ist in jeder Lage möglich.

BH	ø 1"/26 mm	ø 30 mm	ø 34 mm	ø 36 mm	ø 40 mm
6,0	57526-0601	57530-0601	57534-0601		
7,0				57536-0701	
8,0					57540-0801
9,5	57526-0951	57530-0951	57534-0951	57536-0951	
12,0		57530-1201	57534-1201	57536-1201	57540-1201
14,0	57526-1401	57530-1401	57534-1401	57536-1401	
19,0	57526-1901	57530-1901	57534-1901	57536-1901	
22,0	57526-2201	57530-2201	57534-2201		

AUFKIPPMONTAGEN für ZEISS DIARANGE



Tip-off mounts for Zeiss Diarange / Montages basculants pour Zeiss Diarange



Aufkippmontage in besonders niedriger Bauhöhe passend für Weaver-/Picatinny-Profil speziell für ZEISS DIARANGE und alle Zielfernrohre mit 45°-Innenschiene. In Verbindung mit unseren Weaver-Basen und- Schienen kann sie auf allen gängigen Repetierbüchsen verwendet werden.

BH 7 mm mit Dreikantmutter
57945-0700

BH 7 mm mit Polyformhebel
57545-0700

AUFKIPPMONTAGEN für Picatinny-/Weaver-Profil



Tip-off mount for Picatinny/Weaver / Montages basculants pour rail Picatinny/Weaver



Zweiteilige Aufkippmontage für alle Weaver-bzw. Picatinny-Schienen speziell für Swarovski-Rail SR Zielfernrohre mit Zahnprofil. Mittels federndem Klemmbacken wird diese Montage direkt auf der Schiene befestigt.

BH 7,5 mm mit Dreikantmutter
57053-0050

BH 7,5 mm mit Polyformhebel
57553-0050

SSK-II-MONTAGEN für Picatinny-/Weaver-Profil



SSK-II-one piece scope mounts for Picatinny/Weaver / Montages SSK-II pour Picatinny/Weaver



Schnell-Spann-Kippmontage für Picatinny-/Weaver-Profil. Die Montage ist im vorderen Bereich mit einem speziellen, auswechselbaren Anschlag versehen. Zwei unterschiedlich breite Anschlagplatten für 4 mm und 5 mm breite Nuten gehören zum Lieferumfang. Diese finden je nach Einsatz der Montage auf einer Picatinny- oder Weaver-Schiene Verwendung.



BH [mm]	ø 1"/26 mm	ø 30 mm	ø 34 mm	ø 36 mm	ø 40 mm
15,0	46126-0557	46130-0557	46134-0557	46136-0557	46140-0557
20,0	46126-1057	46130-1057	46134-1057	46136-1057	46140-1057



BH [mm] 45°
13,5 46145-1457



BH [mm] Swarovski SR
13,5 46153-1457



BH [mm] S&B-Convex
13,0 46167-1357



BH [mm] S&B-Convex
14,0 46170-1457

Tip-off mounts for Picatinny/Weaver / Montages basculants pour prisme d'arme Picatinny/Weaver

kurze Ausführung



Aufkippmontage mit federnden Gegendruck-Klemmschiebern und schräggeteilten Ringen.

BH [mm]	ohne Support ø 1"/26 mm	ohne Support ø 30 mm	ohne Support ø 34 mm	ohne Support ø 36 mm	ohne Support ø 40 mm
13,0	57026-0500	57030-0500	57034-0500	57036-0500	57040-0500
18,0	57026-1000	57030-1000	57034-1000	57036-1000	57040-1000
26,0	57026-1800	57030-1800	57034-1800	57036-1800	

BH [mm]	mit Support ø 1"/26 mm	mit Support ø 30 mm	mit Support ø 34 mm	mit Support ø 36 mm	mit Support ø 40 mm
13,0	57126-0500	57130-0500	57134-0500	57136-0500	57140-0500
18,0	57126-1000	57130-1000	57134-1000	57136-1000	57140-1000
26,0	57126-1800	57130-1800	57134-1800	57136-1800	



Aufkippmontage mit federnden Gegendruck-Klemmschiebern u. 70°-Aufnahmeprismen für Zielfernrohre mit Mittelrohrschiene.

BH [mm]	ohne Support	mit Support
12,0	57070-0400	57170-0400
17,0	57070-0900	57170-0900



Aufkippmontage mit federnden Gegendruck-Klemmschiebern und 45°-Aufnahmeprismen.

BH [mm]	ohne Support	mit Support
14,0	57045-0300	57145-0300



Aufkippmontage mit federnden Gegendruck-Klemmschiebern für Swarovski SR-Zielfernrohre mit Innenschiene und Zahnprofil.

BH [mm]	ohne Support	mit Support
13,0	57053-1800	57153-1800



Aufkippmontage mit federnden Gegendruck-Klemmschiebern für S&B-Convex-Schiene.

BH [mm]	ohne Support	mit Support
11,0	57067-1800	57167-1800



Aufkippmontage mit federnden Gegendruck-Klemmschiebern und schräggeteilten Ringen.

BH [mm]	ohne Support ø 1"/26 mm	ohne Support ø 30 mm	ohne Support ø 34 mm	ohne Support ø 36 mm	ohne Support ø 40 mm
13,0	57526-0500	57530-0500	57534-0500	57536-0500	57540-0500
18,0	57526-1000	57530-1000	57534-1000	57536-1000	57540-1000
26,0	57526-1800	57530-1800	57534-1800	57536-1800	

BH [mm]	mit Support ø 1"/26 mm	mit Support ø 30 mm	mit Support ø 34 mm	mit Support ø 36 mm	mit Support ø 40 mm
13,0	57626-0500	57630-0500	57634-0500	57636-0500	57640-0500
18,0	57626-1000	57630-1000	57634-1000	57636-1000	57640-1000
26,0	57626-1800	57630-1800	57634-1800	57636-1800	



Aufkippmontage mit federnden Gegendruck-Klemmschiebern u. 70°-Aufnahmeprismen für Zielfernrohre mit Mittelrohrschiene.

BH [mm]	ohne Support	mit Support
12,0	57570-0400	57670-0400
17,0	57570-0900	57670-0900



Aufkippmontage mit federnden Gegendruck-Klemmschiebern und 45°-Aufnahmeprismen.

BH [mm]	ohne Support	mit Support
14,0	57545-0300	57645-0300



Aufkippmontage mit federnden Gegendruck-Klemmschiebern für Swarovski SR-Zielfernrohre mit Innenschiene und Zahnprofil.

BH [mm]	ohne Support	mit Support
13,0	57553-1800	57653-1800



Aufkippmontage mit federnden Gegendruck-Klemmschiebern für S&B-Convex-Schiene.

BH [mm]	ohne Support	mit Support
11,0	57567-1800	57667-1800

Tip-off mounts for Picatinny/Weaver / Montages basculants pour prisme d'arme Picatinny/Weaver

um 15,0 mm verlängerte Ausführung



Aufkippmontage mit federnden Gegendruck-Klemmschiebern und schräggeteilten Ringen.

BH [mm]	ohne Support ø 1"/26 mm	ohne Support ø 30 mm	ohne Support ø 34 mm	ohne Support ø 36 mm	ohne Support ø 40 mm
13,0	57226-0500	57230-0500	57234-0500	57236-0500	57240-0500
18,0	57226-1000	57230-1000	57234-1000	57236-1000	57240-1000
26,0	57226-1800	57230-1800	57234-1800	57236-1800	

BH [mm]	mit Support ø 1"/26 mm	mit Support ø 30 mm	mit Support ø 34 mm	mit Support ø 36 mm	mit Support ø 40 mm
13,0	57326-0500	57330-0500	57334-0500	57336-0500	57340-0500
18,0	57326-1000	57330-1000	57334-1000	57336-1000	57340-1000
26,0	57326-1800	57330-1800	57334-1800	57336-1800	



Aufkippmontage mit federnden Gegendruck-Klemmschiebern u. 70°-Aufnahmeprismen für Zielfernrohre mit Mittelrohrschiene.

BH [mm]	ohne Support	mit Support
12,0	57270-0400	57370-0400
17,0	57270-0900	57370-0900



Aufkippmontage mit federnden Gegendruck-Klemmschiebern und 45°-Aufnahmeprismen.

BH [mm]	ohne Support	mit Support
14,0	57245-0300	57345-0300



Aufkippmontage mit federnden Gegendruck-Klemmschiebern für Swarovski SR-Zielfernrohre mit Innenschiene und Zahnprofil.

BH [mm]	ohne Support	mit Support
13,0	57253-1800	57353-1800



Aufkippmontage mit federnden Gegendruck-Klemmschiebern für S&B-Convex-Schiene.

BH [mm]	ohne Support	mit Support
11,0	57267-1800	57367-1800



Aufkippmontage mit federnden Gegendruck-Klemmschiebern und schräggeteilten Ringen.

BH [mm]	ohne Support ø 1"/26 mm	ohne Support ø 30 mm	ohne Support ø 34 mm	ohne Support ø 36 mm	ohne Support ø 40 mm
13,0	57726-0500	57730-0500	57734-0500	57736-0500	57740-0500
18,0	57726-1000	57730-1000	57734-1000	57736-1000	57740-1000
26,0	57726-1800	57730-1800	57734-1800	57736-1800	

BH [mm]	mit Support ø 1"/26 mm	mit Support ø 30 mm	mit Support ø 34 mm	mit Support ø 36 mm	mit Support ø 40 mm
13,0	57826-0500	57830-0500	57834-0500	57836-0500	57840-0500
18,0	57826-1000	57830-1000	57834-1000	57836-1000	57840-1000
26,0	57826-1800	57830-1800	57834-1800	57836-1800	



Aufkippmontage mit federnden Gegendruck-Klemmschiebern u. 70°-Aufnahmeprismen für Zielfernrohre mit Mittelrohrschiene.

BH [mm]	ohne Support	mit Support
12,0	57770-0400	57870-0400
17,0	57770-0900	57870-0900



Aufkippmontage mit federnden Gegendruck-Klemmschiebern und 45°-Aufnahmeprismen.

BH [mm]	ohne Support	mit Support
14,0	57745-0300	57845-0300



Aufkippmontage mit federnden Gegendruck-Klemmschiebern für Swarovski SR-Zielfernrohre mit Innenschiene und Zahnprofil.

BH [mm]	ohne Support	mit Support
13,0	57753-1800	57853-1800



Aufkippmontage mit federnden Gegendruck-Klemmschiebern für S&B-Convex-Schiene.

BH [mm]	ohne Support	mit Support
11,0	57767-1800	57867-1800

One piece tip-off mounts with triangular nut for Picatinny/ Montages basculants Picatinny avec boulons triangulaire

Diese einteilige, sehr niedrig bauende Aufkippmontage aus hochfestem, schwarz eloxiertem Aluminium eignet sich bestens für Picatinny-Schienen nach Mil.-Std. 1913. Die Befestigung der Montage auf der Picatinny-Schiene erfolgt wahlweise über unsere bekannten Dreikantmutter oder Polyformhebel. Die Querschrauben greifen in die Nuten der Picatinny-Schiene ein und dienen so gleichzeitig als Anschlag. Besonderer Wert wurde auf die ergonomische Formgestaltung und abgerundete Kanten gelegt, wodurch sich die Montage hervorragend an Zielfernrohr und Picatinny-Schiene anpasst.



Dreikantmutter / nut

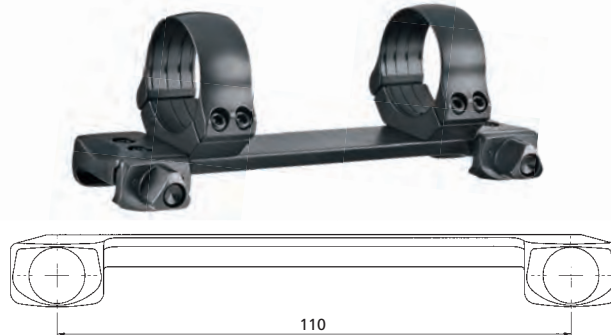

Bolzenabstand 110 mm, Länge 130 mm

Ø 1"/26 mm	BH 10,5 mm	57026-5110
	BH 15,5 mm	57026-1110
Ø 30 mm	BH 10,5 mm	57030-5110
	BH 15,5 mm	57030-1110
Ø 34 mm	BH 10,5 mm	57034-5110
	BH 17,5 mm	57034-1110
Ø 36 mm	BH 10,5 mm	57036-5110
	BH 15,5 mm	57036-1110
Ø 40 mm	BH 10,5 mm	57040-5110
	BH 15,5 mm	57040-1110

one-piece tip-off mounts with polyform lever for Picatinny / Montages basculants avec levier Picatinny polyforme



Polyformhebel / lever

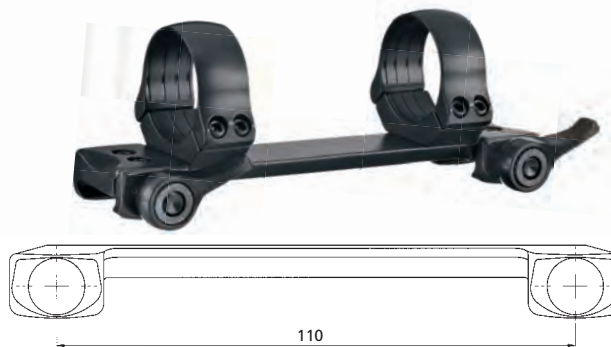

Bolzenabstand 110 mm, Länge 130 mm

Ø 1"/26 mm	BH 10,5 mm	57526-5110
	BH 15,5 mm	57526-1110
Ø 30 mm	BH 10,5 mm	57530-5110
	BH 15,5 mm	57530-1110
Ø 34 mm	BH 10,5 mm	57534-5110
	BH 17,5 mm	57534-1110
Ø 36 mm	BH 10,5 mm	57536-5110
	BH 15,5 mm	57536-1110
Ø 40 mm	BH 10,5 mm	57540-5110
	BH 15,5 mm	57540-1110

AUFKIPPMONTAGE einteilig mit Dreikantmutter für Picatinny-Profil



One piece tip-off mounts with triangular nut for Picatinny/ Montages basculants Picatinny avec boulons triangulaire

Diese einteilige, sehr niedrig bauende Aufkippmontage aus hochfestem, schwarz eloxiertem Aluminium eignet sich bestens für Picatinny-Schienen nach Mil.-Std. 1913 und Zielfernrohre mit Innenschiene. Die Befestigung der Montage auf der Picatinny-Schiene erfolgt wahlweise über unsere bekannten Dreikantmutter oder Polyformhebel. Die Querschrauben greifen in die Nuten der Picatinny-Schiene ein und dienen so gleichzeitig als Anschlag. Besonderer Wert wurde auf die ergonomische Formgestaltung und abgerundete Kanten gelegt, wodurch sich die Montage hervorragend an Zielfernrohr und Picatinny-Schiene anpasst. Lieferbar in zwei Längen.



Dreikantmutter / nut



45°

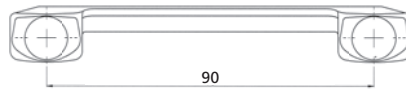

Bolzenabstand 90 mm, Länge 110 mm

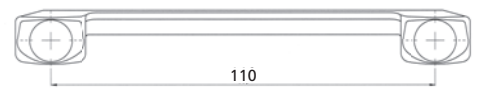

Bolzenabstand 110 mm, Länge 130 mm

BH 8 mm

57045-0090

57045-0110



Swarovski SR

BH 8 mm

57053-0090

57053-0110



S&B Convex

BH 8,5 mm

57067-0090

57067-0110

AUFKIPPMONTAGEN einteilig mit Polyform-Klemmhebel für Picatinny-Profil



one-piece tip-off mounts with polyform lever for Picatinny / Montages basculants avec levier Picatinny polyforme



Polyformhebel / lever



45°

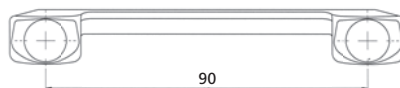

Bolzenabstand 90 mm, Länge 110 mm

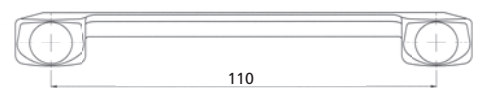

Bolzenabstand 110 mm, Länge 130 mm

BH 8 mm

57545-0090

57545-0110



Swarovski SR

BH 8 mm

57553-0090

57553-0110



S&B Convex

BH 8,5 mm

57567-0090

57567-0110

Aluminium Picatinny mounting rails / Rails style Picatinny

Schwarz eloxiert, zum Aufschrauben auf die Hülse von Repetierbüchsen.
 Befestigungsschrauben gehören zum Lieferumfang.
 Black anodized, to be screwed onto the receiver.
 Fixing screws are included.

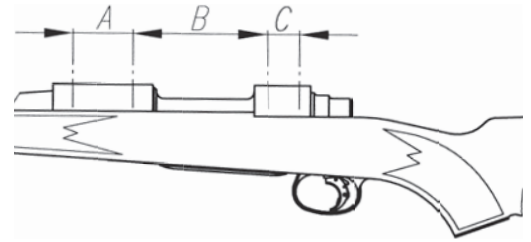

Torxschrauben
 Torx screws



Maße in mm / Measures in mm

Fabrikat – Modell Make – Model	BH Bauhöhe Height	MOA	A	B	C	Best.-Nr. Part #
Anschütz – 1780 / 1781 	6,5	-	21,9	98,5	2x15,4	57050-002B
Antonio Zoli – 1900 	6,5	-	21,84	95,8	12,74	57050-0089
Benelli – ARGO 	6,5	-	12,7	81,0	12,7	57050-0076
Brüner – 19,5 mm Prisma 	12,0	-	-	-	-	57050-0062
FN Browning – A-Bolt III short NEW! 	6,5	-	21,84	82,66	21,84	57050-002T
FN Browning – A-Bolt III long NEW! 	6,5	-	21,84	98,16	21,84	57050-012T
FN Browning – BAR 	6,5	-	12,7	81,0	12,7	57050-0003
FN Browning – Maral 	6,5	-	12,7	81,0	12,7	57050-002J

Aluminium Picatinny mounting rails / Rails style Picatinny

Schwarz eloxiert, zum Aufschrauben auf die Hülse von Repetierbüchsen.
 Befestigungsschrauben gehören zum Lieferumfang.
 Black anodized, to be screwed onto the receiver.
 Fixing screws are included.

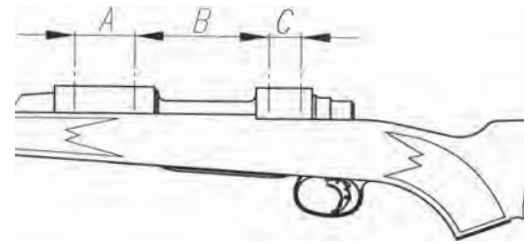

Torxschrauben
 Torx screws



Maße in mm / Measures in mm

Fabrikat – Modell Make – Model	BH Bauhöhe Height	MOA	A	B	C	Best.-Nr. Part #
FN Browning – X-Bolt super short 	10,5	-	17,78	71,74	17,78	57050-021P
FN Browning – X-Bolt short 	10,5	-	17,78	74,74	17,78	57050-001P
FN Browning – X-Bolt long 	10,5	-	17,78	93,84	17,78	57050-011P
Haenel – Jäger 10 (bis Serien-Nr. JX-000920) 	6,5	-	21,9	113,9	15,4	57050-001W
Haenel – Jäger 10 (ab Serien-Nr. JX-000921) 	6,5	-	21,84	113,9	15,24	57050-002C
Haenel – SLB 2000+ 	6,5	-	21,9	98,5	2x15,4	57050-002i
H&K – SLB 2000 	6,5	-	21,9	98,5	2x15,4	57050-0008
Howa – 1500 short 	6,5	-	21,84	98,55	15,24	57050-0059

Aluminium Picatinny mounting rails / Rails style Picatinny

Schwarz eloxiert, zum Aufschrauben auf die Hülse von Repetierbüchsen.
 Befestigungsschrauben gehören zum Lieferumfang.
 Black anodized, to be screwed onto the receiver.
 Fixing screws are included.

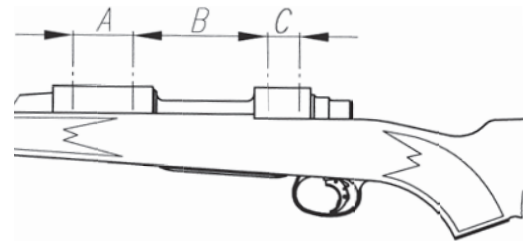

Torxschrauben
 Torx screws



Maße in mm / Measures in mm

Fabrikat – Modell Make – Model	BH Bauhöhe Height	MOA	A	B	C	Best.-Nr. Part #
Howa – 1500 short 	7,5	20	21,84	98,55	15,24	57050-2059
Krico – 700 / 900 / 902 	8,0	-	22,0	103,4	12,7	57050-0006
Marlin – 1894 	7,5	-	12,7	47,6	12,7	57050-001V
Marlin – 1895 / 336 / 338 / 308 / 444 	7,5	-	12,7	69,85	12,7	57050-001S
Mauser – K98 	7,5	-	22,0	102,4	0-13,2	57050-0010
Mauser – K98 	7,5	20	22,0	102,4	0-13,2	57050-2010
Mauser – M12 	6,5	-	21,84	101,66	12,8	57050-002L
NEW! Mauser – M12 	7,5	20	21,84	101,66	12,8	57050-202L

Aluminium Picatinny mounting rails / Rails style Picatinny



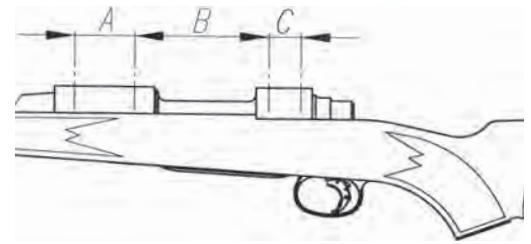





Schwarz eloxiert, zum Aufschrauben auf die Hülse von Repetierbüchsen.
 Befestigungsschrauben gehören zum Lieferumfang.
 Black anodized, to be screwed onto the receiver.
 Fixing screws are included.



Torxschrauben
 Torx screws



Maße in mm / Measures in mm

Fabrikat – Modell Make – Model	BH Bauhöhe Height	MOA	A	B	C	Best.-Nr. Part #
Merkel – SR1 	6,5	-	21,9	88,5	15,4	57050-0098
Merkel – SR1 Basic 	6,5	-	21,9	98,5	2x15,4	57050-002D
Remington – 700 short 	6,5	-	21,84	92,2	15,24	57050-0012
Remington – 700 short 	7,5	20	21,84	92,2	15,24	57050-2012
Remington – 700 long 	6,5	-	21,84	113,9	15,24	57050-0112
Remington – 700 long 	7,5	20	21,84	113,9	15,24	57050-2112
Remington – 783 short 	6,5	-	21,9	82,4	21,9	57050-002S
Remington – 783 short 	7,8	20	21,9	82,4	21,9	57050-202S

Aluminium Picatinny mounting rails / Rails style Picatinny

Schwarz eloxiert, zum Aufschrauben auf die Hülse von Repetierbüchsen.
 Befestigungsschrauben gehören zum Lieferumfang.
 Black anodized, to be screwed onto the receiver.
 Fixing screws are included.

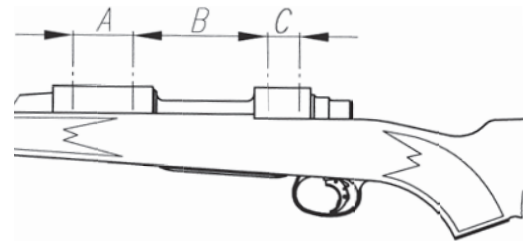

Torxschrauben
 Torx screws



Maße in mm / Measures in mm

Fabrikat – Modell Make – Model	BH Bauhöhe Height	MOA	A	B	C	Best.-Nr. Part #
Remington – 783 long 	6,5	-	21,9	90,0	21,9	57050-012S
Remington – 783 long 	7,8	20	21,9	90,0	21,9	57050-212S
Remington – 7400 / 7600 / 750 	7,0	-	21,84	52,3	15,24	57050-0013
Remington – 870 TAC 	6,5	-	37,46	35,56	-	57050-002H
Rößler – Titan 3 / Titan 6 / Titan α 	6,5	-	21,9	110,0	21,9	57050-0092
Rößler – Titan 16 	6,5	-	21,9	114,0	2x15,35	57050-002G
Ruger – 10 / 22 	7,5	-	12,7	65,35	21,9	57050-001Z
Sabatti – Rover short 	6,5	-	21,9	87,6	15,4	57050-0075

Aluminium Picatinny mounting rails / Rails style Picatinny

Schwarz eloxiert, zum Aufschrauben auf die Hülse von Repetierbüchsen.
 Befestigungsschrauben gehören zum Lieferumfang.
 Black anodized, to be screwed onto the receiver.
 Fixing screws are included.

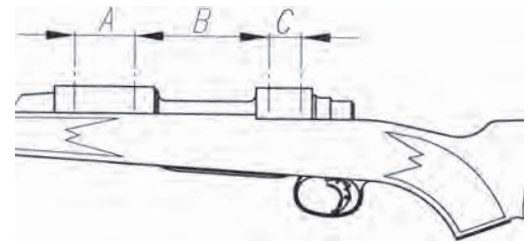

Torxschrauben
 Torx screws



Maße in mm / Measures in mm

Fabrikat – Modell Make – Model	BH Bauhöhe Height	MOA	A	B	C	Best.-Nr. Part #
Sabatti – Rover long 	6,5	-	21,9	102,6	15,4	57050-0175
Sako – 75 / MA05 I / II / III, 85 / MA05 XS / SM / S 	12,5	-	-	-	-	57050-0014
Sako – 75 / MA05 I / II / III, 85 / MA05 XS / SM / S NEW! 	13,8	20	-	-	-	57050-2014
Sako – 75 / MA05 IV / V, 85 / MA05 M / L 	12,5	-	-	-	-	57050-0114
Sako – 75 / MA05 IV / V, 85 / MA05 M / L NEW! 	13,8	20	-	-	-	57050-2114
Sauer – 100 / 101 	6,5	-	21,84	114,0	15,3	57050-002K
Sauer – 202 Standard 	6,5	-	21,84	94,2	21,84	57050-0080
Sauer – 202 Magnum 	6,5	-	21,84	100,2	21,84	57050-0180

Aluminium Picatinny mounting rails / Rails style Picatinny

Schwarz eloxiert, zum Aufschrauben auf die Hülse von Repetierbüchsen.
 Befestigungsschrauben gehören zum Lieferumfang.
 Black anodized, to be screwed onto the receiver.
 Fixing screws are included.

Torxschrauben
 Torx screws

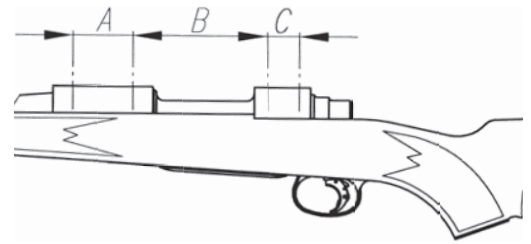

Maße in mm / Measures in mm

Fabrikat – Modell Make – Model	BH Bauhöhe Height	MOA	A	B	C	Best.-Nr. Part #
Sauer – 303 	4,5	-	-	-	-	43357-041R
Savage – gerundete Hülsenbrücke rounded top, short 	6,5	-	21,84	100,1	21,84	57050-0093
Savage – gerundete Hülsenbrücke rounded top, short 	7,0	20	21,84	100,1	21,84	57050-2093
Savage – gerundete Hülsenbrücke rounded top, long 	6,5	-	21,84	117,58	21,84	57050-0193
Savage – gerundete Hülsenbrücke rounded top, long 	7,0	20	21,84	117,58	21,84	57050-2193
Steyr-Mannlicher – M 	7,5	-	10,0	100,5	10,0	57050-0051
Steyr-Mannlicher – SL (Classic, Pro Hunter, Export, SM12, CLII) NEW! 	9,5	-	21,84	56,0	21,84	57050-0488
Steyr-Mannlicher – SL (Classic, Pro Hunter, Export, SM12, CLII) NEW! 	9,5	20	21,84	56,0	21,84	57050-2488

Aluminium Picatinny mounting rails / Rails style Picatinny



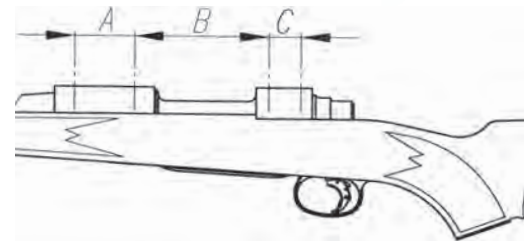





Schwarz eloxiert, zum Aufschrauben auf die Hülse von Repetierbüchsen.
 Befestigungsschrauben gehören zum Lieferumfang.
 Black anodized, to be screwed onto the receiver.
 Fixing screws are included.



Torxschrauben
 Torx screws



Maße in mm / Measures in mm

Fabrikat – Modell Make – Model	BH Bauhöhe Height	MOA	A	B	C	Best.-Nr. Part #
Steyr-Mannlicher – S (Classic, Pro Hunter, Export, SM12, CLII) 	9,5	-	21,84	87,5	21,84	57050-0388
Steyr-Mannlicher – M (Classic, Pro Hunter, Export, SM12, CLII) 	9,5	-	21,84	83,0	21,84	57050-0288
Steyr-Mannlicher – L (Classic, Pro Hunter, Export, SM12, CLII) 	9,5	-	21,84	76,0	21,84	57050-0188
Steyr-Mannlicher – L (Classic, Pro Hunter, Export, SM12, CLII) 	9,5	20	21,84	76,0	21,84	57050-2188
Tikka – T3 	6,5	-	21,9	82,2	21,9	57050-0081
Tikka – T3 	6,5	20	21,9	82,2	21,9	57050-2081
Winchester – 70 short 	6,5	-	21,84	82,8	21,84	57050-0024
Winchester – 70 long 	6,5	-	21,84	96,5	21,84	57050-0124

Aluminium Picatinny mounting rails / Rails style Picatinny

Schwarz eloxiert, zum Aufschrauben auf die Hülse von Repetierbüchsen.
 Befestigungsschrauben gehören zum Lieferumfang.
 Black anodized, to be screwed onto the receiver.
 Fixing screws are included.

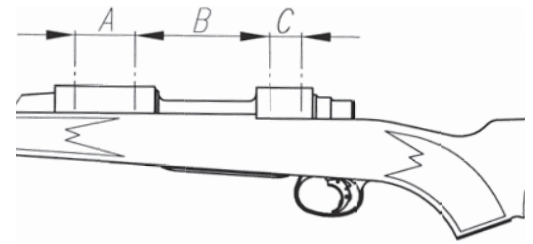

Torxschrauben
 Torx screws



Maße in mm / Measures in mm

Fabrikat – Modell Make – Model	BH Bauhöhe Height	MOA	A	B	C	Best.-Nr. Part #
Winchester – 70 WSM 	6,5	-	21,84	89,4	21,84	57050-0169
Winchester – 70 WSSM 	6,5	-	21,84	81,7	12,7	57050-0069
Winchester – SXR Vulcan 	6,5	-	12,7	81,0	12,7	57050-001J
Winchester – XPR short 	6,5	-	21,84	85,1	21,84	57050-002V
Winchester – XPR long 	6,5	-	21,84	98,1	21,84	57050-012V

Steel Picatinny mounting rails / Rails style Picatinny

Brüniert, zum Aufschrauben auf die Hülse von Repetierbüchsen.
Befestigungsschrauben gehören zum Lieferumfang.
Blued, to be screwed onto the receiver.
Fixing screws are included.

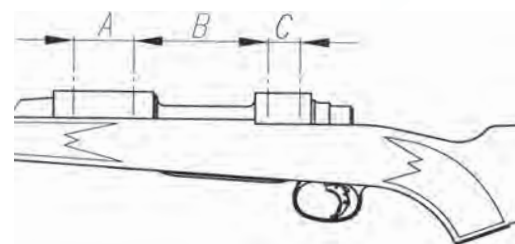

Torxschrauben
Torx screws



Maße in mm / Measures in mm

Fabrikat – Modell Make – Model	BH Bauhöhe Height	MOA	A	B	C	Best.-Nr. Part #
Antonio Zoli – 1900 	6,5	-	21,84	95,8	12,74	57060-0089
FN Browning – BAR 	6,5	-	12,7	81,0	12,7	57060-0003
FN Browning – Maral 	6,5	-	12,7	81,0	12,7	57060-002J
Mauser – K98 	7,5	-	22,0	102,4	0-13,2	57060-0010
Mauser – K98 	7,5	20	22,0	102,4	0-13,2	57060-2010
Mauser – M12 	6,5	-	21,84	101,66	12,8	57060-002L
Mauser – M12 NEW!	7,5	20	21,84	101,66	12,8	57060-202L
Remington – 700 short 	6,5	-	21,84	92,2	15,24	57060-0012

Steel Picatinny mounting rails / Rails style Picatinny

Brüniert, zum Aufschrauben auf die Hülse von Repetierbüchsen.
 Befestigungsschrauben gehören zum Lieferumfang.
 Blued, to be screwed onto the receiver.
 Fixing screws are included.

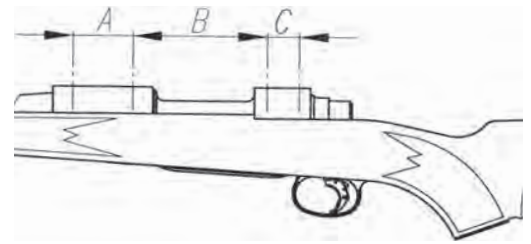

Torxschrauben
 Torx screws



Maße in mm / Measures in mm

Fabrikat – Modell Make – Model	BH Bauhöhe Height	MOA	A	B	C	Best.-Nr. Part #
Remington – 700 short 	7,5	20	21,84	92,2	15,24	57060-2012
Remington – 700 long 	6,5	-	21,84	113,9	15,24	57060-0112
Remington – 700 long 	7,5	20	21,84	113,9	15,24	57060-2112
Sauer – 100 / 101 NEW! 	6,5	-	21,84	114,0	15,3	57060-002K
Sauer – 202 Standard 	6,5	-	21,84	94,2	21,84	57060-0080
Sauer – 202 Standard 	7,0	20	21,84	94,2	21,84	57060-2080
Sauer – 202 Magnum 	6,5	-	21,84	100,2	21,84	57060-0180

Picatinny mounting rail blanks / Rails style Picatinny bruts

Unten eben, für individuelle Gestaltung.
For individual design with flat bottom.

Maße in mm / Measures in mm

Material Material	Quernuten Slots	Länge Length	Bauhöhe Height	Best.-Nr. Part #
Stahl / Steel 	ohne / without	200	8,0	57050-0000
Stahl / Steel 	mit / with	204	10,0	57050-0120
Aluminium 	mit / with	204	10,0	57150-0120
Aluminium 	mit / with	404	10,0	57150-0140

PICATINNY-ADAPTERSCHIENE für 11 mm Prisma

Picatinny rail for 11 mm dovetail / Rail style Picatinny pour prisme d'arme de 11 mm



Gefertigt aus hochfestem Aluminium und schwarz eloxiert. Die Befestigung erfolgt über Klemmbacken mittels Rändelschrauben.

BH 17,5 mm
57050-0011

Extra-long picatinny mounting rails / Rails Weaver/Picatinny longs



Die extra lange Ausführung ermöglicht das Anbringen von Vorsatzgeräten vor dem Zielfernrohr. Wird ein Nachtsichtgerät mit Kopfhalterung verwendet, so ist ein natürliches Anschlagen der Waffe möglich, wenn das Zielfernrohr auf der Picatinny-Schiene nach vorne versetzt wird.
Achtung: Es sind die jeweiligen gesetzlichen Bestimmungen zu beachten.

This extra-long picatinny rail accommodates forward mounted optical devices (i.e. night vision) as well as head mounted systems. When using head mounts, a standard shooting position may be retained if the scope is moved forward on the picatinny rail.
Attention: For the use of night vision or similar optical devices please respect all legal regulations of your country.

Fabrikat	Modell	BH (mm)	Bestell-Nr.	MOA	A	B	C
Remington	700 short	10	57250-0012	-	21,84	92,2	15,24
Remington	700 long	10	57250-0112	-	21,84	113,9	15,24



Picatinny/Weaver mounts for German Claw Mount / Montages „Ponts“ Weaver à crochets



Brückenmontage mit Weaver-Profil zum Aufsetzen auf bereits vorhandene Fussplatte und Schlösschen einer Suhler Einhakmontage. Der Austausch einer veralteten Optik gegen ein modernes ZF oder der Einsatz eines Rotpunktvisiers wird so ohne Löt- und Brünierarbeiten möglich. Im Bereich des Vorderfusses wird die Weaver-Schiene mittels zweier Innensechskantschrauben mit der bereits vorhandenen Fussplatte fest verschraubt. Der Hinterfuß ist längs verschiebbar und kann so auf die Position des Schlösschens eingestellt werden. Die Verwendung einer Distanzrolle erlaubt ausserdem einen Höhenausgleich.

Converts your existing German Claw Mount into a Weaver-style mount and allows the use of a red dot sight. Mount is easy to install. Connect the Weaver rail by means of the two hex screws to the existing front claw mount base. Position the rear part properly and fit it into the existing rear lock of your claw mount. Height adjustment by included spacer. Available in three different lengths to fit to the most popular rifles.

kurz (63 mm - 96 mm)	56300-0097
lang (89 mm - 133 mm)	56300-0134
extra lang (131 mm - 198 mm)	56300-0230

auch mit vollem Hinterfuß lieferbar, Vorderfuß mit Kralle erhältlich

Picatinny/Weaver mounting rails for shotguns / Rails styles Weaver/Picatinny pour armes à canon lisse

Picatinny/Weaver-Schiene zur einfachen Montage von Rotpunktvisieren auf Flinten. Nacharbeiten an der Waffe sind nicht nötig. Die Befestigung erfolgt direkt am Profil der ventilierten Laufschiene. Stabile Klemmhaken umgreifen das Profil und wirken gleichzeitig als Rückstoßstollen. Seitliche Führung durch Gewindestifte mit Messingkuppe zum Schutz des weichen Schienenmaterials. Auch für konische Laufschiene geeignet. Die nutzbare Länge der Montageschiene beträgt 104 mm (9 Quernuten), die Gesamtlänge 161 mm. Wird in der Tabelle keine Bestellnummer angegeben, so ist eine Montage der Schiene aus technischen Gründen nicht möglich.

These durable rails allow you to easily mount a red dot sight onto your shotgun without any permanent modifications. Also suitable for shotguns with parallel or tapered ribs with widths ranging from 6 to 14 mm. Rugged clamps fix the mounting rail to the ventilated rib of most single barrel- or O/U shotguns. At the same time they serve as a recoil lug. 9 equally spaced cross slots eliminate side movement even with the heaviest loads. Total length of the rail is 161 mm, whereas the useable length for positioning your red dot sight is 104 mm. If no order number is listed, there won't be a rail available due to technical reasons.

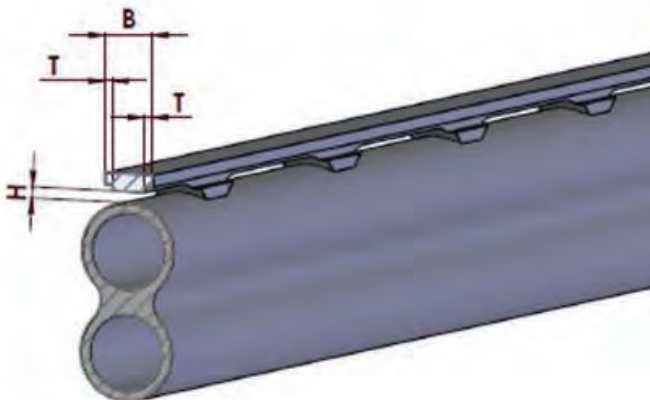

Wie finde ich die richtige Montageschiene?

- ▼ 1.) Schienenbreite „B“ messen
- ▼ 2.) Höhe „H“ Durchlass messen
- ▼ 3.) Tiefe „T“ Absatz messen

How to choose the right mounting rail?

- ▼ 1.) measure width „B“ of the rail
- ▼ 2.) measure height „H“ of the clearance
- ▼ 3.) measure the offset „T“

B	H	T	Best.-Nr.
6,0 - 7,1	0,0 - 1,4 mm	-	-
	1,4 - 2,0 mm	0,0 - 1,5 mm >1,5 mm	57142-0006 -
	>2,0 mm	0,0 - 2,5 mm >2,5 mm	57200-0006 -
7,0 - 8,1	0,0 - 1,4 mm	-	-
	1,4 - 2,0 mm	0,0 - 1,5 mm >1,5 mm	57142-0007 -
	>2,0 mm	0,0 - 2,5 mm >2,5 mm	57200-0007 -
8,0 - 9,1	0,0 - 1,4 mm	-	-
	1,4 - 2,0 mm	0,0 - 1,5 mm >1,5 mm	57142-0008 -
	>2,0 mm	0,0 - 2,5 mm >2,5 mm	57200-0008 -
9,0 - 10,1	0,0 - 1,4 mm	-	-
	1,4 - 2,0 mm	0,0 - 1,5 mm >1,5 mm	57142-0009 -
	>2,0 mm	0,0 - 2,5 mm >2,5 mm	57200-0009 -
10,0 - 11,1	0,0 - 1,4 mm	-	-
	1,4 - 2,0 mm	0,0 - 1,5 mm >1,5 mm	57142-0010 -
	>2,0 mm	0,0 - 2,5 mm >2,5 mm	57200-0010 -
11,0 - 12,1	0,0 - 1,4 mm	-	-
	1,4 - 2,0 mm	0,0 - 1,5 mm >1,5 mm	57142-0011 -
	>2,0 mm	0,0 - 2,5 mm >2,5 mm	57200-0011 -
12,0 - 13,1	0,0 - 1,4 mm	-	-
	1,4 - 2,0 mm	0,0 - 1,5 mm >1,5 mm	57142-0012 -
	>2,0 mm	0,0 - 2,5 mm >2,5 mm	57200-0012 -
13,0 - 14,1	0,0 - 1,4 mm	-	-
	1,4 - 2,0 mm	0,0 - 1,5 mm >1,5 mm	57142-0013 -
	>2,0 mm	0,0 - 2,5 mm >2,5 mm	57200-0013 -

Weaver front - and rear bases / Embasses avants et arrières avec prisme de Weaver

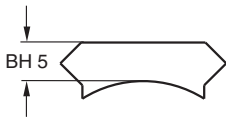

Fabrikat	Modell	Vorderbase	Hinterbase
Anschütz	1780 / 1781	57080-302B	57090-302B
Benelli	ARGO	57080-3076	57090-3076
Beretta	501 S	57080-3026	57090-3026
Chapuis	Express	57080-3029	57090-3029
FFV	Carl Gustaf 1900	57080-3005	57090-3005
FFV	Carl Gustaf 2000 / 3000	57080-3028	57090-3028
FFV	Carl Gustaf 4000	57080-3042	57090-3042
FN Browning	A-Bolt	57080-3020	57090-3020
FN Browning	A-Bolt III	57080-302T	57090-302T
FN Browning	BAR / BLR	57080-3003	57090-3003
FN Browning	Maral	57080-302J	57090-302J
FN Browning	BBR	57080-3004	57090-3004
FN Browning	Eurobolt	57080-3078	57090-3078
FN Browning	European	57080-3056	57090-3056
FN Browning	Mauser	57080-3057	57090-3057
FN Browning	Acera	57080-3077	57090-3077
FN Browning	T-Bolt	57080-301Q	57090-301Q
FN Browning	X-Bolt	57080-301P	57090-301P
Haenel	Jäger 10 (ab Serien-Nr. JX-000921)	57080-302C	57090-302C
Haenel	SLB 2000+	57080-302I	57090-302I
H&K	SLB 2000	57080-3008	57090-3008
Heym	SR 20	57080-3060	57090-3060
Heym	SR 21	57080-3022	57090-3022
Heym	SR 30	57080-3090	57090-3090
Heym	SR 40	57080-3041	57090-3041
Howa	1500	57080-3059	57090-3059
Krico	600 / 700 / 900 / 902 Deluxe	57080-3006	57090-3006
Krieghoff	Semprio	57080-301C	57090-301C
Mauser	M 94	57080-3094	57090-3094
Mauser	M 96	57080-3096	57090-3096
Mauser	M 96 (ab Serien-Nr. 12000 / M 97	57080-3097	57090-3097
Mauser	K 98 (und Nachbauten)	57080-3010	57090-3010
Mauser	M 12	57080-302L	57090-302L
Merkel	SR1 Basic	57080-302D	57090-302D
Remington	700 (Gewinde UNS 6-48)	57080-3012	57090-3012
Remington	700 (Gewinde UNS 8-40)	57080-301N	57090-301N
Remington	7400 / 7600 / 750	57080-3013	57090-3013
Remington	783	57080-302S	57090-302S
Remington	Seven	57080-3019	57090-3019
RWS-Rößler	Titan 3 / Titan 6 / Titan α	57080-3092	57090-3092
RWS-Rößler	Titan 16	57080-302G	57090-302G
Sabatti	Rover 87 DL	57080-3075	57090-3075
Sabatti	Express	57080-301K	57090-301K
Santa Barbara	Repetierbüchse	57080-3044	57090-3044
Sauer	80 / 90 / 92	57080-3015	57090-3015
Sauer	101	57080-302K	57090-302K
Sauer	200	57080-3016	57090-3016
Sauer	202	57080-3080	57090-3080
Savage	gerundete Hülsenbrücke / rounded top	57080-3093	57090-3093
Savage	ebene Hülsenbrücke / flat top	57080-3035	57090-3035
Steyr-Mannlicher	SBS-96 Export / Pro Hunter / Classic / SM12 / CLII	57080-3088	57090-3088
Steyr-Mannlicher	M / S	57080-3051	57090-3051
Swiss Arms	SHR-970 (Bohrungsabstand 21,9 mm)	57080-3040	57090-3040
Verney-Carron	Impact NT / Plus	57080-3047	57090-3047
Voere	LBW	57080-3055	57090-3055
Weatherby	Mark V / 300 / Vanguard	57080-3023	57090-3023
Winchester	70 Standard (Hinterer Bohrungsabstand 21,9 mm)	57080-3024	57090-3024
Winchester	70 Magnum (Baujahr vor 1964, hinterer Bohrungsabstand 11 mm)	57080-3095	57090-3095
Winchester	70 Magnum (Baujahr nach 1964, hinterer Bohrungsabstand 8,3 mm)	57080-3025	57090-3025
Winchester	70 WSM	57080-3011	57090-3011
Winchester	70 WSSM	57080-3069	57090-3069
Winchester	88 / 100	57080-3086	57090-3086
Winchester	SXR Vulcan	57080-301J	57090-301J
Winchester	XPR	57080-302V	57090-302V
Zastava	70	57080-3001	57090-3001

Mounts for Red Dot sights / Montages „Ponts“ pour viseur point rouge

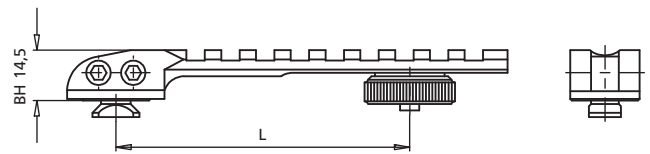

Auf Drückjagden und in Situationen, in denen es auf den schnellen und sicheren Schuss aus kurzer Entfernung ankommt, ist der Einsatz von Rotpunktvisieren vorteilhaft. Brückenmontagen sind für alle Red Dot Visiere mit Picatinny-/Weaver-Aufnahme geeignet. Lieferbar sind zwei verschiedene Längen, die eine Verwendung auf gängigen Kipplaufwaffen und Repetierbüchsen erlauben. In die Brückenmontagen eingefräste Quernuten ermöglichen die spezielle Positionierung des jeweiligen Red Dot Visiers. Diese Montagen sind mit unseren Standard-Verschlusskörpern ausgestattet.

Verschlussabstand L

empfohlene Verwendung

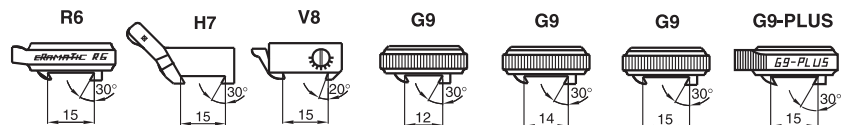

L = 63 - 97 mm

Kipplaufwaffen (ohne Basen / without Base)

Brünner Prisma 16,0 mm

Remington 7400 / 7600 / 750

Voere LBW

61599-9000	71599-9000	81599-9000	91299-9000	91499-9000	91599-9000	91899-9000
61599-9061	71599-9061	81599-9061			91599-9061	91899-9061
61599-9013	71599-9013	81599-9013			91599-9013	91899-9013
61599-9055	71599-9055	81599-9055			91599-9055	91899-9055

L = 90 - 134 mm

Kipplaufwaffen (ohne Basen / without Base)

Antonio Zoli 1900

Benelli ARGO

Beretta 689 gold sable / silver sable 2

Brünner Prisma 19,5 mm

Fair / Rizzini Express

FN Browning A-Bolt

FN Browning A-Bolt III short / long action

FN Browning BAR

FN Browning European

FN Browning Acera

FN Browning Maral

FN Browning X-Bolt

H&K SLB 2000

Heym SR 20

Heym SR 21

Heym SR 30

Krico 600 / 700 / 900 / 902 Deluxe

Krieghoff Semprio

Mauser M 96

Mauser M 96 (ab Serien-Nr. 12000) / M 97

Mauser K 98 (und Nachbauten)

Mauser M12

Merkel SR1

Remington 700

Remington Seven

Remington 783

RWS-Rößler Titan 3 / Titan 6 / Titan α

Sabatti Express

Sauer 80 / 90 / 92

Sauer 101

Sauer 200

Sauer 202

Steyr SBS 96 Exp. / Pro Hunter / Classic / SM12 / CLII

Swiss Arms SHR-970 (BA21,9 mm)

Tikka T3

Verney-Carron

Weatherby Mark V

Winchester 70 short / long action (hinterer BA 21,9 mm)

Winchester 70 Magnum (Baujahr nach 1964, h. BA 8,3mm)

61599-9500	71599-9500	81599-9500	91299-9500	91499-9500	91599-9500	91899-9500
61599-9589	71599-9589	81599-9589			91599-9589	91899-9589
61599-9576	71599-9576	81599-9576			91599-9576	91899-9576
61599-9599	71599-9599	81599-9599			91599-9599	91899-9599
61599-9562	71599-9562	81599-9562			91599-9562	91899-9562
61599-9591	71599-9591	81599-9591			91599-9591	91899-9591
61599-9520	71599-9520	81599-9520			91599-9520	91899-9520
61599-952T	71599-952T	81599-952T			91599-952T	91899-952T
61599-9503	71599-9503	81599-9503			91599-9503	91899-9503
61599-9556	71599-9556	81599-9556			91599-9556	91899-9556
61599-9577	71599-9577	81599-9577			91599-9577	91899-9577
61599-952J	71599-952J	81599-952J			91599-952J	91899-952J
61599-951P	71599-951P	81599-951P			91599-951P	91899-951P
61599-9508	71599-9508	81599-9508			91599-9508	91899-9508
61599-9560	71599-9560	81599-9560			91599-9560	91899-9560
61599-9522	71599-9522	81599-9522			91599-9522	91899-9522
61599-9590	71599-9590	81599-9590			91599-9590	91899-9590
61599-9506	71599-9506	81599-9506			91599-9506	91899-9506
61599-951C	71599-951C	81599-951C			91599-951C	91899-951C
61599-9596	71599-9596	81599-9596			91599-9596	91899-9596
61599-9597	71599-9597	81599-9597			91599-9597	91899-9597
61599-9510	71599-9510	81599-9510			91599-9510	91899-9510
61599-952L	71599-952L	81599-952L			91599-952L	91899-952L
61599-9598	71599-9598	81599-9598			91599-9598	91899-9598
61599-9512	71599-9512	81599-9512			91599-9512	91899-9512
61599-9519	71599-9519	81599-9519			91599-9519	91899-9519
61599-9525	71599-9525	81599-9525			91599-9525	91899-9525
61599-9592	71599-9592	81599-9592			91599-9592	91899-9592
61599-951K	71599-951K	81599-951K			91599-951K	91899-951K
61599-9515	71599-9515	81599-9515			91599-9515	91899-9515
61599-952K	71599-952K	81599-952K			91599-952K	91899-952K
61599-9516	71599-9516	81599-9516			91599-9516	91899-9516
61599-9580	71599-9580	81599-9580			91599-9580	91899-9580
61599-9588	71599-9588	81599-9588			91599-9588	91899-9588
61599-9540	71599-9540	81599-9540			91599-9540	91899-9540
61599-9581	71599-9581	81599-9581			91599-9581	91899-9581
61599-9547	71599-9547	81599-9547			91599-9547	91899-9547
61599-9523	71599-9523	81599-9523			91599-9523	91899-9523
61599-9524	71599-9524	81599-9524			91599-9524	91899-9524
61599-9525	71599-9525	81599-9525			91599-9525	91899-9525

Mounts for Aimpoint-Micro / Montages pour Aimpoint-Micro

Montageplatten mit Klemmhebel für Aimpoint-Micro. Sie eignen sich zum Anbringen auf Weaver- bzw. Picatinny-Schienen, ERAMATIC-Hinterbasen und Schienenplatten mit 30°-Prisma.



für Picatinny-/Weaver-Schienen

57020-1200

für Sauer 303

47620-001R



für 30°-Prismen

für Primenbreite 12 mm

47620-0123

für Primenbreite 15 mm

47620-0150

Mounts for DOCTER sight and Zeiss Compact-Point / Montages pour DOCTER sight et Zeiss Compact-Point

Montageplatten mit Klemmhebel für DOCTER sight, Burris FastFire & Meosight sowie Zeiss Compact-Point. Sie eignen sich zum Anbringen auf Weaver- bzw. Picatinny-Schienen, ERAMATIC-Hinterbasen und Schienenplatten mit 30°-Prisma.



für Picatinny-/Weaver-Schienen

57070-1200

für Sauer 303

47635-001R



für 30°-Prismen

für Primenbreite 12 mm

47635-0123

für Primenbreite 14 mm

47635-0143

für Primenbreite 15 mm

47635-0150

für Primenbreite 16 mm

47635-0160

Montageplatten für DOCTER sight, Burris FastFire & Meosight sowie Zeiss Compact-Point. Sie eignen sich zum Anbringen auf Weaver- bzw. Picatinny-Schienen, ERAMATIC-Hinterbasen und Schienenplatten mit 30°-Prisma sowie zum Einpassen in das Schlösschen für Suhler Einhakmontagen.



für Picatinny/Weaver-Schienen

57070-0000



für Einhakmontagen-Schlösschen

53200-0000



für 30°-Prismen

für Primenbreite 12 mm

47630-0123

für Primenbreite 14 mm

47630-0143

für Primenbreite 15 mm

47630-0150

für Primenbreite 16 mm

47630-0160

für Primenbreite 19,5 mm

47630-0195

MONTAGEN für DOCTER sight



Mounts for DOCTER sight / Montages pour DOCTER sight

Geeignet für alle ERAMATIC-Hinterbasen mit 30°-Prisma und Schienen und Schienenplatten mit 30° auf Kipplaufwaffen.

Suitable for all ERAMATIC rear bases and rails with 30° dovetail attachment on break-down guns.



Montage mit G9-Verschlusskörper

90047-0151

Merkel KR1

47600-001U

FLANKENSCHUTZ für DOCTER sight I und II



Protective wing for DOCTER sight I and II / Protège DOCTER sight I et II



47600-0000

Im alltäglichen Gebrauch im Revier, besonders auf Drückjagden, aber auch im behördlichen Einsatz sind empfindliche Rotpunktvisiere wie das Docter sight oder Burris Fast Fire der Gefahr von Beschädigungen ausgesetzt. Unser Flankenschutz verhindert dies zuverlässig, ohne die Eigenschaften oder die Alltagstauglichkeit Ihrer Optik einzuschränken. Harteloxiertes Aluminium in mattschwarzem Finish sorgt für hohe Widerstandsfähigkeit gegen mechanische Belastung und Witterungseinflüsse. Der Flankenschutz ist problemlos nachrüstbar, indem er zwischen Optik und Montageplatte gesetzt wird. Passende Befestigungsschrauben gehören zum Lieferumfang.

Real life shooting condition may cause damage to your red dot sight. The protective wing, installed between mount base and sight, shields your red dot sight. Made of high grade aluminum it is hardcoat anodized with a matte black finish. It is easy to mount and fits red dot sights like DOCTER, Burris Fast Fire and Meosight. Fixing screws are included.

ABDECKPLATTE für DOCTER sight



Cover plate for DOCTER sight / Plaque der protection pour DOCTER sight



Abdeckplatte aus 0,2 mm starkem Federstahlblech zum Einlegen zwischen DOCTER sight und Montageplatte; verhindert zuverlässig das Eindringen von Feuchtigkeit, Nässe und Schmutz.

Cover plate made of spring steel to be inserted between DOCTER sight and mounting base; reliably prevents the ingress of humidity, moisture and dirt.

Abdeckplatte 0,2 mm für DOCTER sight

00000-6170

Swing mounts for DOCTER sight / Montages „Ponts“ pour DOCTER sight

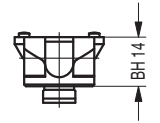
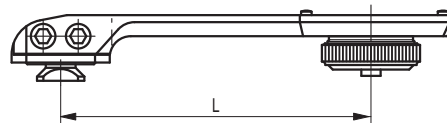

Brückenmontagen zur Aufnahme von Rotpunktvisieren wie DOCTER sight, Burris FastFire und Meosight zur Befestigung auf Kipplauf- und Repetierbüchsen. Sie erhalten unsere Brückenmontagen je nach Einsatz mit und ohne Basen. Sie sind hervorragend geeignet als Wechselmontage, wenn das Zielfernrohr situationsbedingt durch ein red dot sight ersetzt werden soll. Die bereits auf der Waffe montierten Basen dienen dann als Aufnahme. Verfügbar in zwei Längen mit variabel positionierbarem Verschlusskörper.

Wahlweise mit folgenden ERAMATIC-Verschlüssen lieferbar:

Verschlussabstand L

empfohlene Verwendung

L = 63 - 97 mm

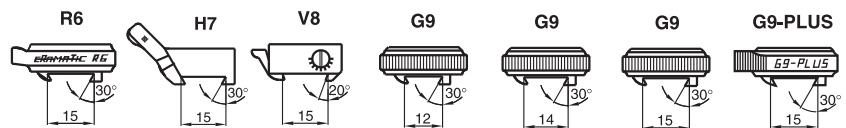

Kipplaufwaffen (ohne Basen / without bases)

Brünner Prisma 16,0 mm	61512-9000	71512-9000	81512-9000	91212-9000	91412-9000	91512-9000	
Remington 7400 / 7600 / 750	61512-9061	71512-9061	81512-9061			91512-9061	91812-9061
Voere LBW	61512-9013	71512-9013	81512-9013			91512-9013	91812-9013
	61512-9055	71512-9055	81512-9055			91512-9055	91812-9055

L = 90 - 134 mm

Kipplaufwaffen (ohne Basen / without bases)

Antonio Zoli 1900	61512-9500	71512-9500	81512-9500	91212-9500	91412-9500	91512-9500	
Benelli ARGO	61512-9589	71512-9589	81512-9589			91512-9589	91812-9589
Beretta 689 gold sable / silver sable 2	61512-9576	71512-9576	81512-9576			91512-9576	91812-9576
Brünner Prisma 19,5 mm	61512-9599	71512-9599	81512-9599			91512-9599	91812-9599
Fair / Rizzini Express	61512-9562	71512-9562	81512-9562			91512-9562	91812-9562
FN Browning A-Bolt	61512-9591	71512-9591	81512-9591			91512-9591	91812-9591
FN Browning A-Bolt III	61512-9520	71512-9520	81512-9520			91512-9520	91812-9520
FN Browning BAR	61512-952T	71512-952T	81512-952T			91512-952T	91812-952T
FN Browning European	61512-9503	71512-9503	81512-9503			91512-9503	91812-9503
FN Browning Acera	61512-9556	71512-9556	81512-9556			91512-9556	91812-9556
FN Browning Maral	61512-9577	71512-9577	81512-9577			91512-9577	91812-9577
FN Browning X-Bolt	61512-952J	71512-952J	81512-952J			91512-952J	91812-952J
H&K SLB 2000	61512-951P	71512-951P	81512-951P			91512-951P	91812-951P
Heym SR 20	61512-9508	71512-9508	81512-9508			91512-9508	91812-9508
Heym SR 21	61512-9560	71512-9560	81512-9560			91512-9560	91812-9560
Heym SR 30	61512-9522	71512-9522	81512-9522			91512-9522	91812-9522
Krico 600 / 700 / 900 / 902 Deluxe	61512-9590	71512-9590	81512-9590			91512-9590	91812-9590
Krieghoff Semprio	61512-9506	71512-9506	81512-9506			91512-9506	91812-9506
Mauser M 96	61512-951C	71512-951C	81512-951C			91512-951C	91812-951C
Mauser M 96 (ab Serien-Nr. 12000) / M 97	61512-9596	71512-9596	81512-9596			91512-9596	91812-9596
Mauser K 98 (und Nachbauten)	61512-9597	71512-9597	81512-9597			91512-9597	91812-9597
Mauser M12	61512-9510	71512-9510	81512-9510			91512-9510	91812-9510
Merkel SR1	61512-952L	71512-952L	81512-952L			91512-952L	91812-952L
Remington 700	61512-9598	71512-9598	81512-9598			91512-9598	91812-9598
Remington Seven	61512-9512	71512-9512	81512-9512			91512-9512	91812-9512
Remington 783	61512-9519	71512-9519	81512-9519			91512-9519	91812-9519
RWS-Röbler Titan 3 / Titan 6 / Titan α	61512-952S	71512-952S	81512-952S			91512-952S	91812-952S
Sabatti Express	61512-9592	71512-9592	81512-9592			91512-9592	91812-9592
Sauer 80 / 90 / 92	61512-951K	71512-951K	81512-951K			91512-951K	91812-951K
Sauer 101	61512-9515	71512-9515	81512-9515			91512-9515	91812-9515
Sauer 200	61512-952K	71512-952K	81512-952K			91512-952K	91812-952K
Sauer 202	61512-9516	71512-9516	81512-9516			91512-9516	91812-9516
Steyr SBS 96 Exp. / Pro Huner / Classic / SM12 / CLII	61512-9580	71512-9580	81512-9580			91512-9580	91812-9580
Swiss Arms SHR-970 (BA21,9 mm)	61512-9588	71512-9588	81512-9588			91512-9588	91812-9588
Tikka T3	61512-9540	71512-9540	81512-9540			91512-9540	91812-9540
Verney-Carron	61512-9581	71512-9581	81512-9581			91512-9581	91812-9581
Weatherby Mark V	61512-9547	71512-9547	81512-9547			91512-9547	91812-9547
Winchester 70 short / long action (hinterer BA 21,9 mm)	61512-9523	71512-9523	81512-9523			91512-9523	91812-9523
Winchester 70 Magnum (Baujahr nach 1964, h. BA 8,3mm)	61512-9524	71512-9524	81512-9524			91512-9524	91812-9524
	61512-9525	71512-9525	81512-9525			91512-9525	91812-9525



LEUPOLD

LEUPOLD

SSK-II-one piece scope mounts with lateral lever for 12 mm dovetail Montages SSK-II pour 12 mm de prisme

Unsere SSK-II-Montage zeichnet sich durch absolute Schussfestigkeit und Wiederholgenauigkeit aus. Mit nur einer Handbewegung wird die Montage an zwei justierbaren Spannstellen auf dem Schienenprisma der Waffe verriegelt. Selbst grosse und schwere Zielfernrohre erhalten so absolut festen Sitz. Der seitlich zurückgezogene Spannhebel ermöglicht eine problemlose Bedienung auch bei Zielfernrohren mit linksseitigem Batterieturm für das Leuchtabsehen.

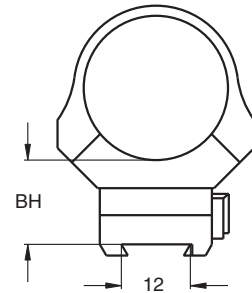
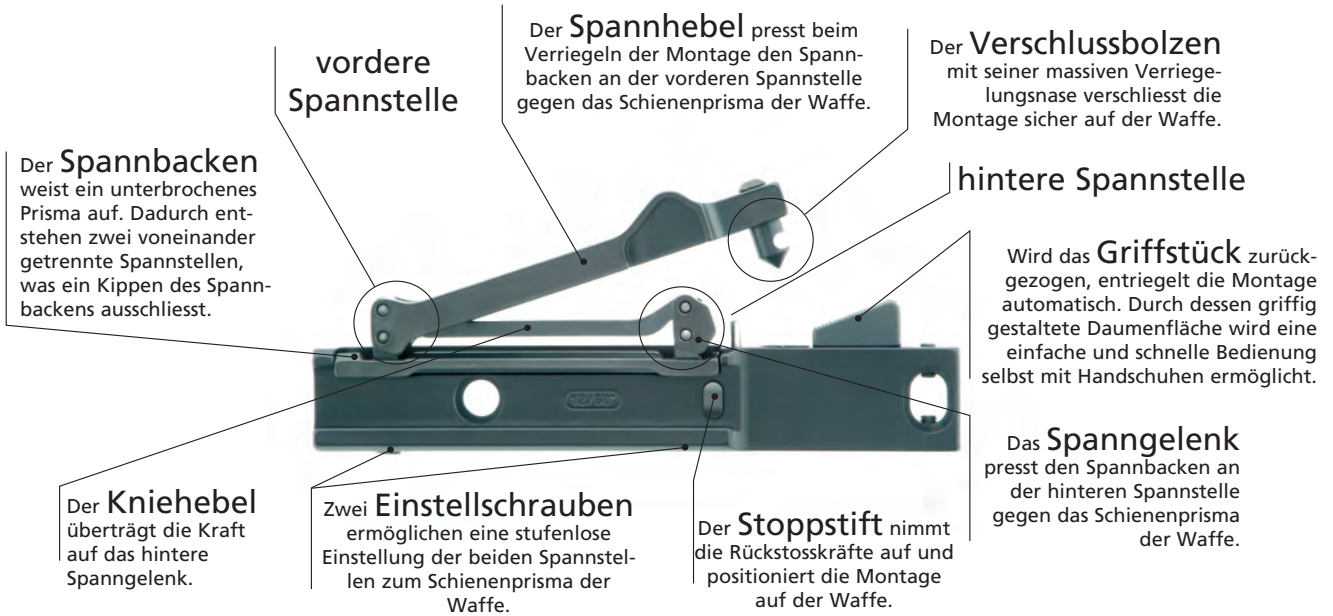

BH [mm]	ø 1"/26 mm	ø 30 mm	ø 34 mm	ø 36 mm	ø 40 mm	BH [mm]	70°
15,0	46126-0512	46130-0512	46134-0512	46136-0512	46140-0512	14,0	46170-1412
20,0	46126-1012	46130-1012	46134-1012	46136-1012	46140-1012		



BH [mm]	45°	BH [mm]	Swarovski SR	BH [mm]	S&B-Convex	BH [mm]	Weaver-Prisma
13,5	46145-1412	13,5	46153-1412	13,0	46167-1312	17,5	46121-1712

SIH-mounts with double locking lever / Montages SIH avec leviers double-sécurité

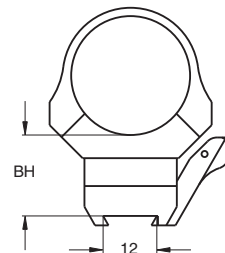

Sicherheits-Hebelmontagen für Kipp Laufwaffen mit Schienenprisma 12 mm. Die SIH-Montage ist werkseitig voreingestellt, muss aber der Prismenschiene entsprechend einjustiert werden. Absolute Schussfestigkeit und Wiederholgenauigkeit wird durch die zweifache Klemmung auf dem Waffenprisma erreicht. Darüber hinaus ist jeder Verschlusshebel mit einer Sperrklinke versehen, welche ein unbeabsichtigtes Öffnen verhindert. In Verbindung mit aufschraubbaren Prismenschiene findet diese Montage nun auch Verwendung auf geeigneten Repetierbüchsen.



BH [mm]	ø 1"/26 mm	ø 30 mm	ø 34 mm	ø 36 mm	ø 40 mm	BH [mm]	70°
17,5	46326-0512	46330-0512	46334-0512	46336-0512	46340-0512	16,5	46370-1712
22,5	46326-1012	46330-1012	46334-1012	46336-1012	46340-1012		



BH [mm]	45°	BH [mm]	Swarovski SR	BH [mm]	S&B-Convex
13,5	46345-1412	17,5	46353-1612	15,5	46367-1612

MONTAGESCHIENEN MIT 12 mm Prisma

Rails with 12 mm dovetail / Rails pour 12 mm de prisme

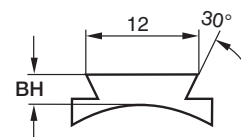

Montageschienen zum Aufschrauben auf Repetierbüchsen.
Sie ermöglichen den Einsatz unserer SSK-II- und SIH-Montagen auf unten genannten Waffenmodellen.

Fabrikat	Modell	BH [mm]	Fabrikat	Modell	BH [mm]
Benelli	ARGO	3,5	Voere	LBW	3,5
FN-Browning	BAR / BLR / CBL	3,5	Steyr-Mannlicher	SBS-96 M Export	4,0
FN-Browning	Maral	3,5	Steyr-Mannlicher	SBS-96 S Export	4,0
H & K	SLB 2000	3,5	Sauer	202	3,5

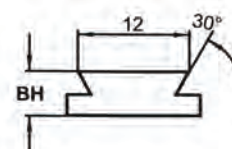

Montageschiene mit 12 mm Prisma,
Länge 150 mm, unten eben, BH 7,5 mm, für individuelle Gestaltung.

47412-0000

Saddle bases and ring bases / Socles de montages



Laufsockel zylindrisch, für Repetierbüchsen und Kipplaufwaffen.
Länge: 38 mm

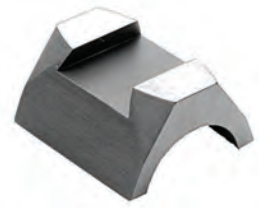

Laufsockel konisch, für Repetierbüchsen und Kipplaufwaffen. Länge: 35 mm

BH 6,0	ø 12,0	50000-0612	BH 7,0	ø 14,0	50000-0714	ø 17,0 : 18,0	50100-1717
BH 6,0	ø 12,7	50000-0613	BH 7,0	ø 15,0	50000-0715	ø 17,5 : 18,5	50100-1718
BH 6,0	ø 14,0	50000-0614	BH 7,0	ø 16,0	50000-0716	ø 18,0 : 18,5	50100-1818
BH 6,0	ø 15,0	50000-0615	BH 7,0	ø 18,0	50000-0718	ø 18,5 : 19,0	50100-1819
BH 6,0	ø 16,0	50000-0616	BH 7,0	ø 20,0	50000-0720	ø 19,5 : 20,0	50100-1920
BH 6,0	ø 17,0	50000-0617	BH 7,0	ø 21,0	50000-0721	ø 20,0 : 21,0	50100-2020
BH 6,0	ø 18,0	50000-0618	BH 7,0	ø 22,0	50000-0722	ø 20,0 : 24,5	50100-2024
BH 6,0	ø 19,0	50000-0619				ø 20,0 : 26,0	50100-2026
BH 6,0	ø 20,0	50000-0620				ø 20,5 : 21,0	50100-2021
BH 6,0	ø 21,0	50000-0621				ø 21,0 : 21,5	50100-2121
BH 6,0	ø 22,0	50000-0622	BH 8,0	ø 16,0	50000-0816	ø 21,0 : 22,0	50100-2122
BH 6,0	ø 23,0	50000-0623	BH 8,0	ø 18,0	50000-0818	ø 21,5 : 22,5	50100-2123
BH 6,0	ø 24,0	50000-0624	BH 8,0	ø 20,0	50000-0820	ø 22,0 : 26,5	50100-2226
BH 6,0	ø 25,0	50000-0625	BH 8,0	ø 21,0	50000-0821	ø 22,0 : 29,0	50100-2229
BH 6,0	ø 28,0	50000-0628	BH 8,0	ø 22,0	50000-0822	ø 23,5 : 29,0	50100-2329
BH 6,0	ø 29,0	50000-0629	BH 8,0	ø 24,0	50000-0824	ø 25,0 : 29,0	50100-2529
						ø 26,0 : 29,0	50100-2629



Laufsockel für Repetierbüchsen und Kipplaufwaffen mit Achtkantlauf.
Länge: 38 mm

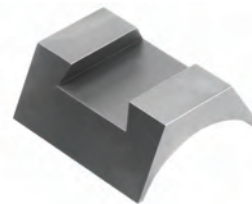

Hülsekopfsattel für Repetierbüchsen. Länge: 38 mm, BH: 6,0 mm



Laufsockelringe mit zylindrischer Bohrung. BH: 6,0 mm

für Laufquerschnitt			für Laufquerschnitt			für Hülse-ø		Länge für Lauf-ø		
BH 6,0	17,0	50200-0617	BH 8,0	18,0	50200-0818	32,0	50300-0632	30,0	29,0	50500-3029
BH 6,0	18,0	50200-0618	BH 8,0	19,0	50200-0819	33,0	50300-0633	35,0	19,0	50500-3519
BH 6,0	19,0	50200-0619	BH 8,0	20,0	50200-0820	34,0	50300-0634	35,0	21,0	50500-3521
BH 6,0	20,0	50200-0620	BH 8,0	21,0	50200-0821	36,0	50300-0636	35,0	23,0	50500-3523
BH 6,0	21,0	50200-0621	BH 8,0	22,0	50200-0822			35,0	25,0	50500-3525
BH 6,0	22,0	50200-0622						35,0	27,0	50500-3527
								35,0	28,0	50500-3528
								35,0	29,0	50500-3529
								35,0	30,0	50500-3530



Schieneinsätze für Drillinge.
Länge: 38 mm

Kaliber 12 Kaliber 16

50900-3812 50900-3816

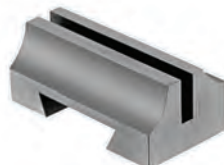

Schieneinsatz für Büchseflinte.
Länge: 38 mm

50902-3800

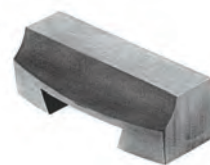

Schieneinsatz für Doppelbüchse.
Länge: 38 mm

50904-3800



Schieneinsatz-Rohling.
Länge: 40 mm

50906-4000

VORDERINGE und VORDERFÜSSE für Einhakmontagen **ERA**

Front rings and front dovetail attachments for German Claw Mount

Anneaux avants et pieds avants pour montages à crochets



ohne Durchsicht.

Ringbreite: 15 mm, Bauhöhe: 5 mm

mit Fussplatte Standard	
ø 1"/26 mm	ø 30 mm
51026-0050	51030-0050



mit Durchsicht.

Ringbreite: 15 mm, Bauhöhe: 7,5 mm

mit Fussplatte Standard	
ø 1"/26 mm	ø 30 mm
51026-0075	51030-0075



mit Durchsicht.

Ringbreite: 15 mm, Bauhöhe: 9,5 mm

mit Fussplatte Standard	
ø 1"/26 mm	ø 30 mm
51026-0095	51030-0095



mit Durchsicht.

Ringbreite: 15 mm, Bauhöhe: 13 mm

mit Fussplatte Standard	
ø 1"/26 mm	ø 30 mm
51026-0130	51030-0130

		mit Fußplatte Standard		mit Fussplatte für Mauser 66	
		ø 30 mm		ø 1"/26 mm ø 30 mm	
		BH 19,0 mm	51030-0190	51026-1130	51030-1130



verlängert, ohne Durchsicht,

Gesamtlänge: 45 mm,

Ringbreite: 15 mm, Bauhöhe: 12 mm

mit Fussplatte Standard

ø 1"/26 mm ø 30 mm

51026-2120 **51030-2120**



verlängert, mit 45°-Aufnahmeprisma,
ohne Durchsicht.

Gesamtlänge: 35 mm, Bauhöhe: 4,5 mm

mit Fussplatte Standard

51045-2045



verlängert, mit 45°-Aufnahmeprisma
und Durchsicht.

Gesamtlänge: 35 mm, Bauhöhe: 10 mm

mit Fussplatte Standard

51045-2100

mit Fussplatte für Mauser 66				mit Fussplatte für Mauser 66	
ø 1"/26 mm ø 30 mm					
51026-4120	51030-4120			51045-4100	



kurz, mit 70°-Aufnahmeprisma,
ohne Durchsicht. Bauhöhe: 4 mm

Fussplatte Standard **51070-0040**

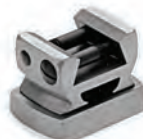

kurz, mit 70°-Aufnahmeprisma
und Durchsicht. Bauhöhe: 6,5 mm

Fussplatte Standard **51070-0065**



verlängert, mit 70°-Aufnahmeprisma,
ohne Durchsicht. Bauhöhe: 4 mm

Fussplatte Standard **51070-2040**



verlängert,

mit 70°-Aufnahmeprisma und Durchsicht.
Bauhöhe: 6,5 mm

Fussplatte Standard **51070-2065**



verlängert,

mit 70°-Aufnahmeprisma und Durchsicht.
Bauhöhe: 10 mm

Fussplatte Standard **51070-2100**

Fussplatte für Mauser 66 **51070-4100**



extra lang,

mit 70°-Aufnahmeprisma, ohne Durchsicht.
Gesamtlänge: 45 mm, Bauhöhe: 12 mm

Fussplatte Standard **51070-6120**

Fussplatte für Mauser 66 **51070-7120**

ERA VORDERFÜSSE für Swarovski SR für Einhakmontagen

Front dovetail attachments with dental profile for German Claw Mount

Pieds avants dentelés pour montages à crochets



verlängert,
ohne Durchsicht.
Gesamtlänge: 35 mm, Bauhöhe: 7,5 mm
mit Fussplatte Standard

51053-2075



verlängert,
mit Durchsicht.
Gesamtlänge: 35 mm, Bauhöhe: 10 mm
mit Fussplatte Standard

51053-2100



extra lang,
ohne Durchsicht.
Gesamtlänge: 50 mm, Bauhöhe: 10 mm
mit Fussplatte Standard

51053-6100

Die hier vorgestellten Vorderfüsse lassen sich beliebig mit anderen Produkten aus unserer umfangreichen Auswahl an Laufsockeln und Schieneneinsätzen für Suhler Einhakmontagen kombinieren. Nach einer Art Baukastensystem wählen Sie je nach Waffentyp und Zielfernrohr zwischen verschiedenen, für Ihre Zwecke am besten geeigneten Ausführungen.

ERA VORDERFÜSSE für S&B-Convex-Schiene für Einhakmontagen

Front dovetail attachments for S&B-Convex-Rail for German Claw Mount

Pieds avants pour S&B Convex montages à crochets



verlängert, ohne Durchsicht.
Gesamtlänge: 45 mm, Bauhöhe: 7,5 mm
mit Fussplatte Standard

51067-2075



verlängert, ohne Durchsicht.
Gesamtlänge: 45 mm, Bauhöhe: 10 mm
mit Fussplatte Standard

51067-2100

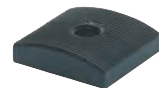

Geriffelte Klemmleiste für alle Montagearten
mit S&B-Convex-Schiene.

00000-2227



Front rings for German Claw Mount / Pieds avants pour montages à crochets

Befestigung am Objektivrohr, doppelt geteilt mit Kleberillen. Sie erhalten diese Klemmringe im Durchmesser 36,0 bis 48,0 mm mit Ringbreite 15,0 mm und im Durchmesser 48,0 bis 65,0 mm mit Ringbreite 20 mm jeweils mit aufgepasster Fussplatte. Auf Wunsch auch mit Fussplatte für Mauser 66 lieferbar.



Ringbreite 15 mm und Standard-Fussplatte.			Ringbreite 20 mm und Standard-Fussplatte.		
Ring-ø [mm]	ohne Durchsicht BH = 4,5 mm	mit Durchsicht BH = 7,5 mm	Ring-ø [mm]	ohne Durchsicht BH = 4,5 mm	mit Durchsicht BH = 7,5 mm
36,0		52025-7536	48,0	52021-4548	52026-7548
37,0		52025-7537	49,5		52026-7549
38,0		52025-7538	50,0	52021-4550	52026-7550
39,0		52025-7539	51,0		52026-7551
39,5		52025-5539	52,0	52021-4552	52026-7552
40,0	52020-4540	52025-7540	54,0	52021-4554	52026-7554
41,0		52025-7541	56,0	52021-4556	52026-7556
42,0	52020-4542	52025-7542	57,0	52021-4557	52026-7557
44,0		52025-7544	58,3	52021-4558	52026-7558
46,0		52025-7546	59,0	52021-4559	52026-7559
47,0	52020-4547	52025-7547	61,0	52021-4561	
48,0	52020-4548	52025-7548	62,0	52021-4562	52026-7562
			64,0	52021-4564	52026-7564
			65,0	52021-4565	



Doppelt geteilt, mit Kleberillen, verlängertem Fuss, und aufgepasster Fussplatte. Auf Wunsch auch mit Fussplatte für Mauser 66 lieferbar.

	Ring-ø [mm]	ohne Durchsicht BH = 7,5 mm
ohne Durchsicht BH: 7,5 mm Ring + Verlängerung: 30 mm Ringbreite: 20 mm mit Standard-Fussplatte	48,0	52040-7548
	54,0	52040-7554
	56,0	52040-7556
	57,0	52040-7557
	62,0	52040-7562
	64,0	52040-7564



Extra breit, doppelt geteilt, mit Kleberillen, 6 Klemmschrauben und aufgepasster Fussplatte. Auf Wunsch auch mit Fussplatte für Mauser 66 lieferbar.

	Ring-ø [mm]	ohne Durchsicht BH = 4,5 mm	ohne Durchsicht BH = 7,5 mm
ohne Durchsicht BH: 4,5 mm bzw. 7,5 mm Ringbreite: 25 mm mit Standard-Fussplatte	48,0	52060-4548	52060-7548
	54,0	52060-4554	52060-7554
	56,0	52060-4556	52060-7556
	57,0	52060-4557	52060-7557
	62,0	52060-4562	52060-7562
	64,0	52060-4564	52060-7564
	80,0	52060-4580	52060-7580

FUSSPLATTEN für Einhakmontagen

Bases for German Claw Mount / Patins pour montages à crochets



Standard-Ausführung, passend für Vorderfüsse und vordere Klemmringe.

51000-0000



Für Mauser 66, passend für Vorderfüsse und vordere Klemmringe.

51000-4000



Rohling, für Einhakmontagen, Maße 34 x 25 x 6.

51000-2000

Rear bases with look for German Claw Mount / Serrures pour montages à crochets



Ebene Ausführung,
zur individuellen Verwendung.

BH [mm]	Ausführung	
	breit	schmal
6,0	53000-3006	
9,0	53000-3009	53000-7009
11,0	53000-3011	



Für Mauser K 98,
ohne Bohrungen, zum Auflöten.

Ausführung	
breit	schmal
53005-3000	53005-7000



Für Doppelbüchse,
mit konisch vorgefrästen Radien.

Ausführung
breit
53010-3000



Für BBF,
mit konisch vorgefrästem Radius.

Ausführung	
breit	schmal
53015-3000	53015-7000



Für Drillinge,
mit konisch vorgefrästen Radien.

Kal.	Ausführung	
	breit	schmal
12,0	53020-3012	53020-7012
16,0	53020-3016	



Für Drillinge,
einbaufertig vorgefräst.

Fabrikat	Ausführung
	breit
Heym	53025-3010
Kriehoff	53025-3020
Suhler	53025-3030



Für diverse Prismen.

passend zu	Ausführung
	breit
KK-Büchsen	53030-3010
Blaser BBF	53030-3020
Heym BBF	53030-3030
Brünner BBF	53030-3040
SAKO-Büchsen	53030-3050



Für Mannlicher-Schönauer GK.

Ausführung
zum seitlichen Anschrauben
53035-0000
Passende Gesteckteile für Mannlicher-Schönauer GK siehe Seite 35



Mit Bohrungen,
zum Anschrauben
auf der Hülsenbrücke
von Repetierbüchsen.

Fabrikat	Modell	Fabrikat	Modell
FFV	Carl-Gustaf 1900	Remington	700
	53040-3005		7400 / 7600
FN Browning	Carl-Gustaf 2000 / 3000	Santa Barbara	Repetierbüchse
	53040-3028	Sauer	80 / 90
Heym	BAR		200
	European		202
Heym	SR 20	Steyr-Mannlicher	SL / L
	53040-3056		M / S
Heym	SR 21		L- / M- / S-Luxus
	53040-3060	Voere	2165 Kufstein
Heym	SR 30	Weatherby	MarkV/300/Vanguard
	53040-3090	Winchester	70 short / long action
Krico	SR 40	Zastava	70
	53040-3041		
Krico	600 / 700 / 900 / 902 Deluxe		
	53040-3006		
Mauser	66		
	53040-3009		
Mauser	K 98 (und Nachbauten)		
	53040-3010		
Parker Hale	Safari		
	53040-3030		

Rear rings for German Claw Mount / Colliers arrières pour montages à crochets

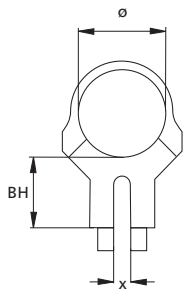

Ohne Support;
kurze Ausführung.

breit

x = 6 mm



Mit Support;
kurze Ausführung.

breit

x = 6 mm



Mit Support;
volle Ausführung.



Mit Support;
um 20,0 mm verlängerte
Ausführung.

breit

x = 6 mm

ø 1"/26 mm

BH 8,5		54023-2608		BH 11,0	54063-2611
BH 10,0	54003-2610	54023-2610		BH 13,0	54063-2613
BH 12,0	54003-2612	54023-2612		BH 15,0	54063-2615
BH 14,0	54003-2614	54023-2614		BH 17,0	54063-2617
BH 16,0	54003-2616	54023-2616		BH 19,0	54063-2619
BH 18,0	54003-2618	54023-2618		BH 21,0	54063-2621
BH 20,0	54003-2620	54023-2620		BH 23,0	54063-2623
BH 22,0	54003-2622	54023-2622		BH 25,0	54063-2625
BH 25,0	54003-2625	54023-2625		BH 28,0	54063-2628
BH 28,0	54003-2628	54023-2628			
volle Ausführung			54023-2677	voll	54063-2677

ø 30 mm

BH 8,5		54023-3008		BH 11,0	54063-3011
BH 10,0	54003-3010	54023-3010		BH 13,0	54063-3013
BH 12,0	54003-3012	54023-3012		BH 15,0	54063-3015
BH 14,0	54003-3014	54023-3014		BH 17,0	54063-3017
BH 16,0	54003-3016	54023-3016		BH 19,0	54063-3019
BH 18,0	54003-3018	54023-3018		BH 21,0	54063-3021
BH 20,0	54003-3020	54023-3020		BH 23,0	54063-3023
BH 22,0	54003-3022	54023-3022		BH 25,0	54063-3025
BH 25,0	54003-3025	54023-3025		BH 28,0	54063-3028
BH 28,0	54003-3028	54023-3028			
volle Ausführung			54023-3077	voll	54063-3077

ø 34 mm

BH 8,5		54023-3408			
BH 10,0		54023-3410			
BH 12,0		54023-3412			
BH 14,0		54023-3414			
BH 16,0		54023-3416			
BH 18,0		54023-3418			
BH 20,0		54023-3420			
BH 22,0		54023-3422			
BH 25,0		54023-3425			
BH 28,0		54023-3428			
volle Ausführung			54023-3477		

ø 36 mm

BH 8,5		54023-3608			
BH 10,0		54023-3610			
BH 12,0		54023-3612			
BH 14,0		54023-3614			
BH 16,0		54023-3616			
BH 18,0		54023-3618			
BH 20,0		54023-3620			
BH 22,0		54023-3622			
BH 25,0		54023-3625			
BH 28,0		54023-3628			
volle Ausführung			54023-3677		

70° dovetail attachments for German Claw Mount / Pieds arrière 70° pour montages à crochets

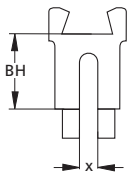

Ohne Support;
kurze Ausführung.



Mit Support;
kurze Ausführung.



Mit Support;
verlängerte Ausführung.

BH [mm]	breit x = 6 mm	breit x = 6 mm	breit x = 6 mm
6,0	54423-7006		
8,0	54423-7008		
8,5		54443-7008	54483-7008
10,0	54423-7010	54443-7010	54483-7010
12,0	54423-7012	54443-7012	54483-7012
14,0	54423-7014	54443-7014	54483-7014
16,0	54423-7016	54443-7016	54483-7016
18,0	54423-7018	54443-7018	54483-7018
20,0	54423-7020	54443-7020	54483-7020
22,0	54423-7022	54443-7022	54483-7022
25,0	54423-7025	54443-7025	54483-7025
28,0		54443-7028	54483-7028
volle Ausführung	54423-7077	54443-7077	54483-7077

45° dovetail attachments for German Claw Mount / Pieds arrière 45° pour montages à crochets

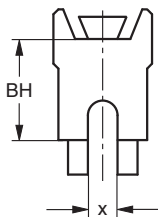

Ohne Support;
kurze Ausführung.



Ohne Support;
verlängerte Ausführung.



Mit Support;
verlängerte Ausführung.

BH [mm]	breit x = 6 mm	breit x = 6 mm	breit x = 6 mm
8,0	54603-4508	54623-4508	
8,5			54643-4508
10,0	54603-4510	54623-4510	54643-4510
12,0	54603-4512	54623-4512	54643-4512
14,0	54603-4514	54623-4514	54643-4514
16,0	54603-4516	54623-4516	54643-4516
18,0	54603-4518	54623-4518	54643-4518
20,0	54603-4520	54623-4520	54643-4520
22,0	54603-4522	54623-4522	54643-4522
25,0	54603-4525	54623-4525	54643-4525
28,0	54603-4528	54623-4528	
volle Ausführung	54603-4577		54643-4577

HINTERFÜSSE für S&B-Convex-Schiene für Einhakmontagen



Rear dovetail attachments for S&B-Convex-Rail for German Claw Mount / Pieds arrière S&B avec profil „Convex“ pour montages à crochets

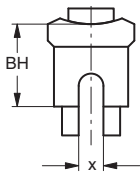

Ohne Support; kurze Ausführung.



Mit Support; verlängerte Ausführung.

BH [mm]	breit x = 6 mm	breit x = 6 mm
6,0	54703-6706	
8,0	54703-6708	
8,5		54743-6708
10,0	54703-6710	54743-6710
12,0	54703-6712	54743-6712
14,0	54703-6714	54743-6714
16,0	54703-6716	54743-6716
18,0	54703-6718	54743-6718
20,0	54703-6720	54743-6720
22,0	54703-6722	54743-6722
25,0	54703-6725	54743-6725
28,0	54703-6728	54743-6728
volle Ausführung	54703-6777	54743-6777

HINTERFÜSSE für Swarovski SR für Einhakmontagen



Rear dovetail attachments for Swarovski SR / Pieds arrière pour Swarovski SR

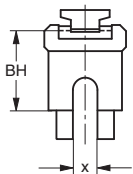

Ohne Support;
kurze Ausführung.



Ohne Support;
verlängerte Ausführung.



Mit Support;
verlängerte Ausführung.

BH [mm]	breit x = 6 mm	breit x = 6 mm	breit x = 6 mm
8,0	54803-5308	54823-5308	
10,0	54803-5310	54823-5310	
12,0	54803-5312	54823-5312	54843-5312
14,0	54803-5314	54823-5314	54843-5314
16,0	54803-5316	54823-5316	54843-5316
18,0	54803-5318	54823-5318	54843-5318
20,0	54803-5320	54823-5320	54843-5320
volle Ausführung	54803-5377	54823-5377	54843-5377

HINTERRINGE und -FÜSSE für Mannlicher-Schönauer GK



Rear rings and dovetail attachments for Mannlicher GK / Colliers et pieds arrière pour Mannlicher-Schönauer GK



Mit Support und vollem Fuss;
für Bauhöhen bis 26 mm.

ø 1 1/2 mm ø 30 mm

56000-2626 56000-3026



Mit 70°-Aufnahmeprisma,
mit Support und vollem Fuss;
für Bauhöhen bis 26 mm.

56030-7026



Mit 45°-Aufnahmeprisma,
mit Support und vollem Fuss;
für Bauhöhen bis 26 mm.

56020-4526



Für Swarovski SR
mit Support und vollem Fuss;
für Bauhöhen bis 26 mm.

56050-5326

Mit Light-Ringen $\varnothing 1''/26 \text{ mm}$ / $\varnothing 30 \text{ mm}$ / $\varnothing 34 \text{ mm}$ / $\varnothing 36 \text{ mm}$
 One piece swing mounts with aluminum rings $\varnothing 1''/26 \text{ mm}$ / $\varnothing 30 \text{ mm}$ / $\varnothing 34 \text{ mm}$ / $\varnothing 36 \text{ mm}$
 Montages „Ponts“ avec colliers alu. $\varnothing 1''/26 \text{ mm}$ / $\varnothing 30 \text{ mm}$ / $\varnothing 34 \text{ mm}$ / $\varnothing 36 \text{ mm}$

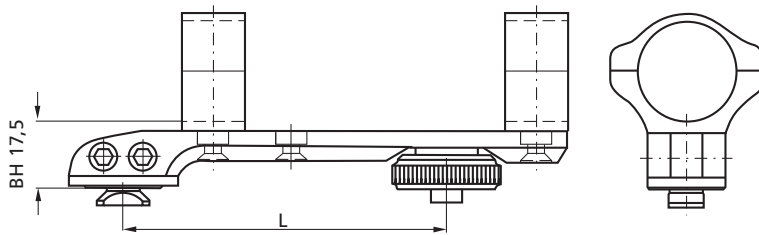

Seite
53-56

Mit 70° -Aufnahmeprisma
 One piece swing mounts with 70° dovetail attachment / Montages „Ponts“ avec 70° de prisme

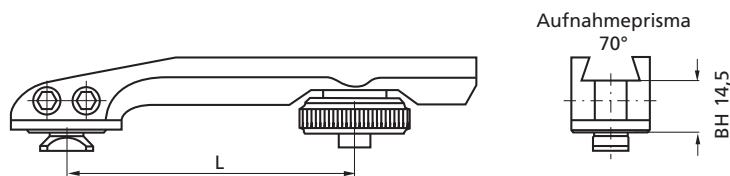

Seite
57

Mit 45° -Aufnahmeprisma
 One piece swing mounts with 45° dovetail attachment / Montages „Ponts“ avec 45° de prisme

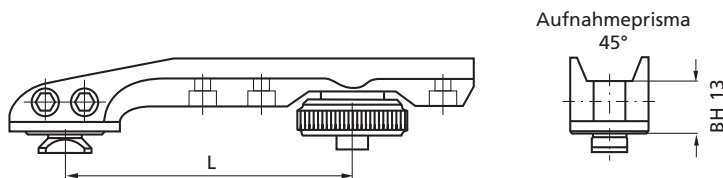

Seite
58

Für Swarovski SR
 One piece swing mounts for Swarovski SR / Montages „Ponts“ pour Swarovski SR

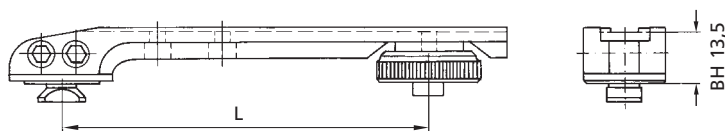

Seite
59

Für S&B-Convex-Schiene
 One piece swing mounts for S&B-Convex-Rail / Montages „Ponts“ pour S&B avec profil „Convex“

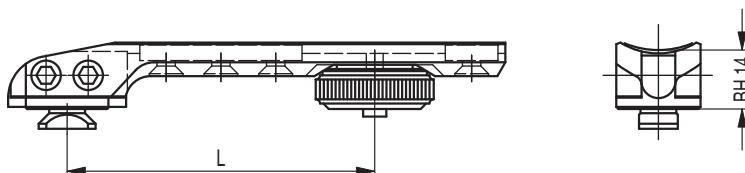

Seite
60

BRÜCKENMONTAGEN mit Light-Ringen ø 1"/26 mm



One piece swing mounts with aluminum rings ø 1"/26 mm / Montages „Ponts“ avec alu. colliers ø 1"/26 mm

Verschluss- abstand L		wahlweise mit folgenden ERAMATIC-Verschlüssen lieferbar:						
		R6	H7	V8	G9	G9	G9	G9-PLUS
73,0 mm	Kipplaufwaffen (ohne Basen / without bases)	61524-1000	71524-1000	81524-1000	91224-1000	91424-1000	91524-1000	91824-1000
	Remington 7400 / 7600 / 750	61524-1013	71524-1013	81524-1013			91524-1013	91824-1013
93,0 mm	Kipplaufwaffen (ohne Basen / without bases)	61524-1500	71524-1500	81524-1500	91224-1500	91424-1500	91524-1500	91824-1500
	FN Browning A-Bolt WSSM	61524-151G	71524-151G	81524-151G			91524-151G	91824-151G
	FN Browning X-Bolt short	61524-151P	71524-151P	81524-151P			91524-151P	91824-151P
	Sabatti Express	61524-151K	71524-151K	81524-151K			91524-151K	91824-151K
	Steyr-Man.L (SBS 96 Export/Pro Hunter/Classic/SM12/CLII)	61524-1588	71524-1588	81524-1588			91524-1588	91824-1588
103,0 mm	Kipplaufwaffen (ohne Basen / without bases)	61524-2000	71524-2000	81524-2000	91224-2000	91424-2000	91524-2000	91824-2000
	FN Browning A-Bolt III short	61524-202T	71524-202T	81524-202T			91524-202T	91824-202T
	Krico 600 / 700 / 900	61524-2006	71524-2006	81524-2006			91524-2006	91824-2006
	Remington 783 short	61524-202S	71524-202S	81524-202S			91524-202S	91824-202S
	Steyr-Man.M (SBS 96 Export/Pro Hunter/Classic/SM12/CLII)	61524-2088	71524-2088	81524-2088			91524-2088	91824-2088
	Tikka T3	61524-2081	71524-2081	81524-2081			91524-2081	91824-2081
	Winchester 70 short (hint. BA 21,9 mm)	61524-2024	71524-2024	81524-2024			91524-2024	91824-2024
109,0 mm	Kipplaufwaffen (ohne Basen / without bases)	61524-2500	71524-2500	81524-2500	91224-2500	91424-2500	91524-2500	91824-2500
	Benelli Argo	61524-2576	71524-2576	81524-2576			91524-2576	91824-2576
	Brünnner CZ Prisma 19,5 mm	61524-2562	71524-2562	81524-2562			91524-2562	91824-2562
	Chapuis Express	61524-2529	71524-2529	81524-2529			91524-2529	91824-2529
	FN Browning BAR	61524-2503	71524-2503	81524-2503			91524-2503	91824-2503
	FN Browning Acera	61524-2577	71524-2577	81524-2577			91524-2577	91824-2577
	FN Browning Maral	61524-252J	71524-252J	81524-252J			91524-252J	91824-252J
	FN Browning X-Bolt long	61524-251P	71524-251P	81524-251P			91524-251P	91824-251P
	Merkel SR1	61524-2598	71524-2598	81524-2598			91524-2598	91824-2598
	Remington 700 short	61524-2512	71524-2512	81524-2512			91524-2512	91824-2512
	Remington 783 long	61524-252S	71524-252S	81524-252S			91524-252S	91824-252S
	Steyr SL	61524-2517	71524-2517	81524-2517			91524-2517	91824-2517
	Steyr-Man.S (SBS 96 Export/Pro Hunter/Classic/SM12/CLII)	61524-2588	71524-2588	81524-2588			91524-2588	91824-2588
116,0 mm	Kipplaufwaffen (ohne Basen / without bases)	61524-5000	71524-5000	81524-5000	91224-5000	91424-5000	91524-5000	91824-5000
	Anschütz 1780 / 1781	61524-502B	71524-502B	81524-502B			91524-502B	91824-502B
	Haenel SLB 2000+	61524-502I	71524-502I	81524-502I			91524-502I	91824-502I
	H & K SLB 2000	61524-5008	71524-5008	81524-5008			91524-5008	91824-5008
	Mauser M12	61524-502L	71524-502L	81524-502L			91524-502L	91824-502L
	Merkel SR1 Basic	61524-502D	71524-502D	81524-502D			91524-502D	91824-502D
	Sauer 202	61524-5080	71524-5080	81524-5080			91524-5080	91824-5080
	Steyr L	61524-5018	71524-5018	81524-5018			91524-5018	91824-5018
	Steyr SBS - L	61524-5087	71524-5087	81524-5087			91524-5087	91824-5087
	Swiss Arms SHR 970 (BA 21,9 mm)	61524-5040	71524-5040	81524-5040			91524-5040	91824-5040
	Verney-Carron Impact NT / Plus	61524-5047	71524-5047	81524-5047			91524-5047	91824-5047
	Winchester 70 long (hintere BA 21,9 mm)	61524-5024	71524-5024	81524-5024			91524-5024	91824-5024
122,0 mm	Kipplaufwaffen (ohne Basen / without bases)	61524-5500	71524-5500	81524-5500	91224-5500	91424-5500	91524-5500	91824-5500
	Brünnner Magnum Prisma 19,5 mm	61524-5562	71524-5562	81524-5562			91524-5562	91824-5562
	FN Browning A-Bolt	61524-5520	71524-5520	81524-5520			91524-5520	91824-5520
	FN Browning A-Bolt III long	61524-552T	71524-552T	81524-552T			91524-552T	91824-552T
	FN Browning European	61524-5556	71524-5556	81524-5556			91524-5556	91824-5556
	Heym SR 20	61524-5560	71524-5560	81524-5560			91524-5560	91824-5560
	Mauser 98 (und Nachbauten)	61524-5510	71524-5510	81524-5510			91524-5510	91824-5510
	Sauer 200	61524-5516	71524-5516	81524-5516			91524-5516	91824-5516
	Sauer 202 Magnum	61524-5580	71524-5580	81524-5580			91524-5580	91824-5580
126,0 mm	Kipplaufwaffen (ohne Basen / without bases)	61524-6000	71524-6000	81524-6000	91224-6000	91424-6000	91524-6000	91824-6000
	Sauer 200 Magnum	61524-6016	71524-6016	81524-6016			91524-6016	91824-6016
	Steyr M	61524-6051	71524-6051	81524-6051			91524-6051	91824-6051
	Steyr S	61524-6052	71524-6052	81524-6052			91524-6052	91824-6052
	Winchester 70 Magnum (hint. BA 8,3 mm)	61524-6025	71524-6025	81524-6025			91524-6025	91824-6025
131,0 mm	Kipplaufwaffen (ohne Basen / without bases)	61524-6500	71524-6500	81524-6500	91224-6500	91424-6500	91524-6500	91824-6500
	Haenel Jäger 10 (ab Serien-Nr. JX-000921)	61524-652C	71524-652C	81524-652C			91524-652C	91824-652C
	Heym SR 21	61524-6522	71524-6522	81524-6522			91524-6522	91824-6522
	Mauser M 96	61524-6596	71524-6596	81524-6596			91524-6596	91824-6596
	Mauser M 96 (ab Serien-Nr. 12000)/M 97	61524-6597	71524-6597	81524-6597			91524-6597	91824-6597
	Remington 700 long	61524-6512	71524-6512	81524-6512			91524-6512	91824-6512
	RWS-Rößler Titan 3 / Titan 6 / Titan α	61524-6592	71524-6592	81524-6592			91524-6592	91824-6592
	RWS-Rößler Titan 16	61524-652G	71524-652G	81524-652G			91524-652G	91824-652G
	Sauer 80 / 90 / 92	61524-6515	71524-6515	81524-6515			91524-6515	91824-6515
	Sauer 101	61524-652K	71524-652K	81524-652K			91524-652K	91824-652K
	Weatherby Mark V	61524-6523	71524-6523	81524-6523			91524-6523	91824-6523

One piece swing mounts with aluminum rings 30 mm / Montages „Ponts“ avec colliers alu. ø 30 mm

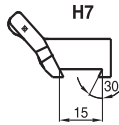
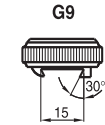
Verschluss- abstand L		wahlweise mit folgenden ERAMATIC-Verschlüssen lieferbar:							
		R6 	H7 	V8 	G9 	G9 	G9 	G9-PLUS 	
73,0 mm	Kipplaufwaffen (ohne Basen / without bases)	61528-1000	71528-1000	81528-1000	91228-1000	91428-1000	91528-1000	91828-1000	
	Remington 7400 / 7600 / 750	61528-1013	71528-1013	81528-1013			91528-1013	91828-1013	
93,0 mm	Kipplaufwaffen (ohne Basen / without bases)	61528-1500	71528-1500	81528-1500	91228-1500	91428-1500	91528-1500	91828-1500	
	FN Browning A-Bolt WSSM	61528-151G	71528-151G	81528-151G			91528-151G	91828-151G	
	FN Browning X-Bolt short	61528-151P	71528-151P	81528-151P			91528-151P	91828-151P	
	Sabatti Express	61528-151K	71528-151K	81528-151K			91528-151K	91828-151K	
	Steyr-Man.L (SBS 96 Export/Pro Hunter/Classic/SM12/CLII)	61528-1588	71528-1588	81528-1588			91528-1588	91828-1588	
103,0 mm	Kipplaufwaffen (ohne Basen / without bases)	61528-2000	71528-2000	81528-2000	91228-2000	91428-2000	91528-2000	91828-2000	
	FN Browning A-Bolt III short	61528-202T	71528-202T	81528-202T			91528-202T	91828-202T	
	Krico 600 / 700 / 900	61528-2006	71528-2006	81528-2006			91528-2006	91828-2006	
	Remington 783 short	61528-202S	71528-202S	81528-202S			91528-202S	91828-202S	
	Steyr-Man.M (SBS 96 Export/Pro Hunter/Classic/SM12/CLII)	61528-2088	71528-2088	81528-2088			91528-2088	91828-2088	
	Tikka T3	61528-2081	71528-2081	81528-2081			91528-2081	91828-2081	
	Winchester 70 short (hint. BA 21,9 mm)	61528-2024	71528-2024	81528-2024			91528-2024	91828-2024	
109,0 mm	Kipplaufwaffen (ohne Basen / without bases)	61528-2500	71528-2500	81528-2500	91228-2500	91428-2500	91528-2500	91828-2500	
	Benelli Argo	61528-2576	71528-2576	81528-2576			91528-2576	91828-2576	
	Brüner CZ Prisma 19,5 mm	61528-2562	71528-2562	81528-2562			91528-2562	91828-2562	
	Chapuis Express	61528-2529	71528-2529	81528-2529			91528-2529	91828-2529	
	FN Browning BAR	61528-2503	71528-2503	81528-2503			91528-2503	91828-2503	
	FN Browning Acera	61528-2577	71528-2577	81528-2577			91528-2577	91828-2577	
	FN Browning Maral	61528-252J	71528-252J	81528-252J			91528-252J	91828-252J	
	FN Browning X-Bolt long	61528-251P	71528-251P	81528-251P			91528-251P	91828-251P	
	Merkel SR1	61528-2598	71528-2598	81528-2598			91528-2598	91828-2598	
	Remington 700 short	61528-2512	71528-2512	81528-2512			91528-2512	91828-2512	
	Remington 783 long	61528-252S	71528-252S	81528-252S			91528-252S	91828-252S	
	Steyr SL	61528-2517	71528-2517	81528-2517			91528-2517	91828-2517	
	Steyr-Man.S (SBS 96 Export/Pro Hunter/Classic/SM12/CLII)	61528-2588	71528-2588	81528-2588			91528-2588	91828-2588	
116,0 mm	Kipplaufwaffen (ohne Basen / without bases)	61528-5000	71528-5000	81528-5000	91228-5000	91428-5000	91528-5000	91828-5000	
	Anschütz 1780 / 1781	61528-502B	71528-502B	81528-502B			91528-502B	91828-502B	
	Haenel SLB 2000+	61528-502I	71528-502I	81528-502I			91528-502I	91828-502I	
	H & K SLB 2000	61528-5008	71528-5008	81528-5008			91528-5008	91828-5008	
	Mauser M12	61528-502L	71528-502L	81528-502L			91528-502L	91828-502L	
	Merkel SR1 Basic	61528-502D	71528-502D	81528-502D			91528-502D	91828-502D	
	Sauer 202	61528-5080	71528-5080	81528-5080			91528-5080	91828-5080	
	Steyr L	61528-5018	71528-5018	81528-5018			91528-5018	91828-5018	
	Steyr SBS - L	61528-5087	71528-5087	81528-5087			91528-5087	91828-5087	
	Swiss Arms SHR 970 (BA 21,9 mm)	61528-5040	71528-5040	81528-5040			91528-5040	91828-5040	
	Verney-Carron Impact NT / Plus	61528-5047	71528-5047	81528-5047			91528-5047	91828-5047	
	Winchester 70 long (hintere BA 21,9 mm)	61528-5024	71528-5024	81528-5024			91528-5024	91828-5024	
122,0 mm	Kipplaufwaffen (ohne Basen / without bases)	61528-5500	71528-5500	81528-5500	91228-5500	91428-5500	91528-5500	91828-5500	
	Brüner Magnum Prisma 19,5 mm	61528-5562	71528-5562	81528-5562			91528-5562	91828-5562	
	FN Browning A-Bolt	61528-5520	71528-5520	81528-5520			91528-5520	91828-5520	
	FN Browning A-Bolt III long	61528-552T	71528-552T	81528-552T			91528-552T	91828-552T	
	FN Browning European	61528-5556	71528-5556	81528-5556			91528-5556	91828-5556	
	Heym SR 20	61528-5560	71528-5560	81528-5560			91528-5560	91828-5560	
	Mauser 98 (und Nachbauten)	61528-5510	71528-5510	81528-5510			91528-5510	91828-5510	
	Sauer 200	61528-5516	71528-5516	81528-5516			91528-5516	91828-5516	
	Sauer 202 Magnum	61528-5580	71528-5580	81528-5580			91528-5580	91828-5580	
126,0 mm	Kipplaufwaffen (ohne Basen / without bases)	61528-6000	71528-6000	81528-6000	91228-6000	91428-6000	91528-6000	91828-6000	
	Sauer 200 Magnum	61528-6016	71528-6016	81528-6016			91528-6016	91828-6016	
	Steyr M	61528-6051	71528-6051	81528-6051			91528-6051	91828-6051	
	Steyr S	61528-6052	71528-6052	81528-6052			91528-6052	91828-6052	
	Winchester 70 Magnum (hint. BA 8,3 mm)	61528-6025	71528-6025	81528-6025			91528-6025	91828-6025	
131,0 mm	Kipplaufwaffen (ohne Basen / without bases)	61528-6500	71528-6500	81528-6500	91228-6500	91428-6500	91528-6500	91828-6500	
	Haenel Jäger 10 (ab Serien-Nr. JX-000921)	61528-652C	71528-652C	81528-652C			91528-652C	91828-652C	
	Heym SR 21	61528-6522	71528-6522	81528-6522			91528-6522	91828-6522	
	Mauser M 96	61528-6596	71528-6596	81528-6596			91528-6596	91828-6596	
	Mauser M 96 (ab Serien-Nr. 12000)/M 97	61528-6597	71528-6597	81528-6597			91528-6597	91828-6597	
	Remington 700 long	61528-6512	71528-6512	81528-6512			91528-6512	91828-6512	
	RWS-Rößler Titan 3 / Titan 6 / Titan α	61528-6592	71528-6592	81528-6592			91528-6592	91828-6592	
	RWS-Rößler Titan 16	61528-652G	71528-652G	81528-652G			91528-652G	91828-652G	
	Sauer 80 / 90 / 92	61528-6515	71528-6515	81528-6515			91528-6515	91828-6515	
	Sauer 101	61528-652K	71528-652K	81528-652K			91528-652K	91828-652K	
	Weatherby Mark V	61528-6523	71528-6523	81528-6523			91528-6523	91828-6523	

One piece swing mounts with steel rings ø 34 mm / Montages „Ponts“ avec colliers ø 34 mm

Verschluss- abstand L		wahlweise mit folgenden ERAMATIC-Verschlüssen lieferbar:							
		R6	H7	V8	G9	G9	G9	G9-PLUS	
73,0 mm	Kipplaufwaffen (ohne Basen / without bases)	61534-1000	71534-1000	81534-1000	91234-1000	91434-1000	91534-1000	91834-1000	
	Remington 7400 / 7600 / 750	61534-1013	71534-1013	81534-1013			91534-1013	91834-1013	
93,0 mm	Kipplaufwaffen (ohne Basen / without bases)	61534-1500	71534-1500	81534-1500	91234-1500	91434-1500	91534-1500	91834-1500	
	FN Browning A-Bolt WSSM	61534-151G	71534-151G	81534-151G			91534-151G	91834-151G	
	FN Browning X-Bolt short	61534-151P	71534-151P	81534-151P			91534-151P	91834-151P	
	Sabatti Express	61534-151K	71534-151K	81534-151K			91534-151K	91834-151K	
	Steyr-Man.L (SBS 96 Export/Pro Hunter/Classic/SM12/CLII)	61534-1588	71534-1588	81534-1588			91534-1588	91834-1588	
103,0 mm	Kipplaufwaffen (ohne Basen / without bases)	61534-2000	71534-2000	81534-2000	91234-2000	91434-2000	91534-2000	91834-2000	
	FN Browning A-Bolt III short	61534-202T	71534-202T	81534-202T			91534-202T	91834-202T	
	Krico 600 / 700 / 900	61534-2006	71534-2006	81534-2006			91534-2006	91834-2006	
	Remington 783 short	61534-202S	71534-202S	81534-202S			91534-202S	91834-202S	
	Steyr-Man.M (SBS 96 Export/Pro Hunter/Classic/SM12/CLII)	61534-2088	71534-2088	81534-2088			91534-2088	91834-2088	
	Tikka T3	61534-2081	71534-2081	81534-2081			91534-2081	91834-2081	
	Winchester 70 short (hint. BA 21,9 mm)	61534-2024	71534-2024	81534-2024			91534-2024	91834-2024	
	Kipplaufwaffen (ohne Basen / without bases)	61534-2500	71534-2500	81534-2500	91234-2500	91434-2500	91534-2500	91834-2500	
109,0 mm	Benelli Argo	61534-2576	71534-2576	81534-2576			91534-2576	91834-2576	
	Brüner CZ Prisma 19,5 mm	61534-2562	71534-2562	81534-2562			91534-2562	91834-2562	
	Chapuis Express	61534-2529	71534-2529	81534-2529			91534-2529	91834-2529	
	FN Browning BAR	61534-2503	71534-2503	81534-2503			91534-2503	91834-2503	
	FN Browning Acera	61534-2577	71534-2577	81534-2577			91534-2577	91834-2577	
	FN Browning Maral	61534-252J	71534-252J	81534-252J			91534-252J	91834-252J	
	FN Browning X-Bolt long	61534-251P	71534-251P	81534-251P			91534-251P	91834-251P	
	Merkel SR1	61534-2598	71534-2598	81534-2598			91534-2598	91834-2598	
	Remington 700 short	61534-2512	71534-2512	81534-2512			91534-2512	91834-2512	
	Remington 783 long	61534-252S	71534-252S	81534-252S			91534-252S	91834-252S	
	Steyr SL	61534-2517	71534-2517	81534-2517			91534-2517	91834-2517	
	Steyr-Man.S (SBS 96 Export/Pro Hunter/Classic/SM12/CLII)	61534-2588	71534-2588	81534-2588			91534-2588	91834-2588	
	116,0 mm	Kipplaufwaffen (ohne Basen / without bases)	61534-5000	71534-5000	81534-5000	91234-5000	91434-5000	91534-5000	91834-5000
		Anschütz 1780 / 1781	61534-502B	71534-502B	81534-502B			91534-502B	91834-502B
Haenel SLB 2000+		61534-502I	71534-502I	81534-502I			91534-502I	91834-502I	
H & K SLB 2000		61534-5008	71534-5008	81534-5008			91534-5008	91834-5008	
Mauser M12		61534-502L	71534-502L	81534-502L			91534-502L	91834-502L	
Merkel SR1 Basic		61534-502D	71534-502D	81534-502D			91534-502D	91834-502D	
Sauer 202		61534-5080	71534-5080	81534-5080			91534-5080	91834-5080	
Steyr L		61534-5018	71534-5018	81534-5018			91534-5018	91834-5018	
Steyr SBS - L		61534-5087	71534-5087	81534-5087			91534-5087	91834-5087	
Swiss Arms SHR 970 (BA 21,9 mm)		61534-5040	71534-5040	81534-5040			91534-5040	91834-5040	
Verney-Carron Impact NT / Plus		61534-5047	71534-5047	81534-5047			91534-5047	91834-5047	
Winchester 70 long (hintere BA 21,9 mm)		61534-5024	71534-5024	81534-5024			91534-5024	91834-5024	
122,0 mm		Kipplaufwaffen (ohne Basen / without bases)	61534-5500	71534-5500	81534-5500	91234-5500	91434-5500	91534-5500	91834-5500
		Brüner Magnum Prisma 19,5 mm	61534-5562	71534-5562	81534-5562			91534-5562	91834-5562
	FN Browning A-Bolt	61534-5520	71534-5520	81534-5520			91534-5520	91834-5520	
	FN Browning A-Bolt III long	61534-552T	71534-552T	81534-552T			91534-552T	91834-552T	
	FN Browning European	61534-5556	71534-5556	81534-5556			91534-5556	91834-5556	
	Heym SR 20	61534-5560	71534-5560	81534-5560			91534-5560	91834-5560	
	Mauser 98 (und Nachbauten)	61534-5510	71534-5510	81534-5510			91534-5510	91834-5510	
	Sauer 200	61534-5516	71534-5516	81534-5516			91534-5516	91834-5516	
	Sauer 202 Magnum	61534-5580	71534-5580	81534-5580			91534-5580	91834-5580	
	126,0 mm	Kipplaufwaffen (ohne Basen / without bases)	61534-6000	71534-6000	81534-6000	91234-6000	91434-6000	91534-6000	91834-6000
Sauer 200 Magnum		61534-6016	71534-6016	81534-6016			91534-6016	91834-6016	
Steyr M		61534-6051	71534-6051	81534-6051			91534-6051	91834-6051	
Steyr S		61534-6052	71534-6052	81534-6052			91534-6052	91834-6052	
Winchester 70 Magnum (hint. BA 8,3 mm)		61534-6025	71534-6025	81534-6025			91534-6025	91834-6025	
131,0 mm	Kipplaufwaffen (ohne Basen / without bases)	61534-6500	71534-6500	81534-6500	91234-6500	91434-6500	91534-6500	91834-6500	
	Haenel Jäger 10 (ab Serien-Nr. JX-000921)	61534-652C	71534-652C	81534-652C			91534-652C	91834-652C	
	Heym SR 21	61534-6522	71534-6522	81534-6522			91534-6522	91834-6522	
	Mauser M 96	61534-6596	71534-6596	81534-6596			91534-6596	91834-6596	
	Mauser M 96 (ab Serien-Nr. 12000)/M 97	61534-6597	71534-6597	81534-6597			91534-6597	91834-6597	
	Remington 700 long	61534-6512	71534-6512	81534-6512			91534-6512	91834-6512	
	RWS-Rößler Titan 3 / Titan 6 / Titan α	61534-6592	71534-6592	81534-6592			91534-6592	91834-6592	
	RWS-Rößler Titan 16	61534-652G	71534-652G	81534-652G			91534-652G	91834-652G	
	Sauer 80 / 90 / 92	61534-6515	71534-6515	81534-6515			91534-6515	91834-6515	
	Sauer 101	61534-652K	71534-652K	81534-652K			91534-652K	91834-652K	
	Weatherby Mark V	61534-6523	71534-6523	81534-6523			91534-6523	91834-6523	

One piece swing mounts with steel rings 36 mm / Montages „Ponts“ avec colliers ø 36 mm

Verschluss- abstand L		wahlweise mit folgenden ERAMATIC-Verschlüssen lieferbar:							
		R6 	H7 	V8 	G9 	G9 	G9 	G9-PLUS 	
73,0 mm	Kipplaufwaffen (ohne Basen / without bases)	61536-1000	71536-1000	81536-1000	91236-1000	91436-1000	91536-1000	91836-1000	
	Remington 7400 / 7600 / 750	61536-1013	71536-1013	81536-1013			91536-1013	91836-1013	
93,0 mm	Kipplaufwaffen (ohne Basen / without bases)	61536-1500	71536-1500	81536-1500	91236-1500	91436-1500	91536-1500	91836-1500	
	FN Browning A-Bolt WSSM	61536-151G	71536-151G	81536-151G			91536-151G	91836-151G	
	FN Browning X-Bolt short	61536-151P	71536-151P	81536-151P			91536-151P	91836-151P	
	Sabatti Express	61536-151K	71536-151K	81536-151K			91536-151K	91836-151K	
	Steyr-Man.L (SBS 96 Export/Pro Hunter/Classic/SM12/CLII)	61536-1588	71536-1588	81536-1588			91536-1588	91836-1588	
103,0 mm	Kipplaufwaffen (ohne Basen / without bases)	61536-2000	71536-2000	81536-2000	91236-2000	91436-2000	91536-2000	91836-2000	
	FN Browning A-Bolt III short	61536-202T	71536-202T	81536-202T			91536-202T	91836-202T	
	Krico 600 / 700 / 900	61536-2006	71536-2006	81536-2006			91536-2006	91836-2006	
	Remington 783 short	61536-202S	71536-202S	81536-202S			91536-202S	91836-202S	
	Steyr-Man.M (SBS 96 Export/Pro Hunter/Classic/SM12/CLII)	61536-2088	71536-2088	81536-2088			91536-2088	91836-2088	
	Tikka T3	61536-2081	71536-2081	81536-2081			91536-2081	91836-2081	
	Winchester 70 short (hint. BA 21,9 mm)	61536-2024	71536-2024	81536-2024			91536-2024	91836-2024	
109,0 mm	Kipplaufwaffen (ohne Basen / without bases)	61536-2500	71536-2500	81536-2500	91236-2500	91436-2500	91536-2500	91836-2500	
	Benelli Argo	61536-2576	71536-2576	81536-2576			91536-2576	91836-2576	
	Brünnner CZ Prisma 19,5 mm	61536-2562	71536-2562	81536-2562			91536-2562	91836-2562	
	Chapuis Express	61536-2529	71536-2529	81536-2529			91536-2529	91836-2529	
	FN Browning BAR	61536-2503	71536-2503	81536-2503			91536-2503	91836-2503	
	FN Browning Acera	61536-2577	71536-2577	81536-2577			91536-2577	91836-2577	
	FN Browning Maral	61536-252J	71536-252J	81536-252J			91536-252J	91836-252J	
	FN Browning X-Bolt long	61536-251P	71536-251P	81536-251P			91536-251P	91836-251P	
	Merkel SR1	61536-2598	71536-2598	81536-2598			91536-2598	91836-2598	
	Remington 700 short	61536-2512	71536-2512	81536-2512			91536-2512	91836-2512	
	Remington 783 long	61536-252S	71536-252S	81536-252S			91536-252S	91836-252S	
	Steyr SL	61536-2517	71536-2517	81536-2517			91536-2517	91836-2517	
	Steyr-Man.S (SBS 96 Export/Pro Hunter/Classic/SM12/CLII)	61536-2588	71536-2588	81536-2588			91536-2588	91836-2588	
	116,0 mm	Kipplaufwaffen (ohne Basen / without bases)	61536-5000	71536-5000	81536-5000	91236-5000	91436-5000	91536-5000	91836-5000
Anschütz 1780 / 1781		61536-502B	71536-502B	81536-502B			91536-502B	91836-502B	
Haenel SLB 2000+		61536-502I	71536-502I	81536-502I			91536-502I	91836-502I	
H & K SLB 2000		61536-5008	71536-5008	81536-5008			91536-5008	91836-5008	
Mauser M12		61536-502L	71536-502L	81536-502L			91536-502L	91836-502L	
Merkel SR1 Basic		61536-502D	71536-502D	81536-502D			91536-502D	91836-502D	
Sauer 202		61536-5080	71536-5080	81536-5080			91536-5080	91836-5080	
Steyr L		61536-5018	71536-5018	81536-5018			91536-5018	91836-5018	
Steyr SBS - L		61536-5087	71536-5087	81536-5087			91536-5087	91836-5087	
Swiss Arms SHR 970 (BA 21,9 mm)		61536-5040	71536-5040	81536-5040			91536-5040	91836-5040	
Verney-Carron Impact NT / Plus		61536-5047	71536-5047	81536-5047			91536-5047	91836-5047	
Winchester 70 long (hintere BA 21,9 mm)		61536-5024	71536-5024	81536-5024			91536-5024	91836-5024	
122,0 mm		Kipplaufwaffen (ohne Basen / without bases)	61536-5500	71536-5500	81536-5500	91236-5500	91436-5500	91536-5500	91836-5500
		Brünnner Magnum Prisma 19,5 mm	61536-5562	71536-5562	81536-5562			91536-5562	91836-5562
		FN Browning A-Bolt	61536-5520	71536-5520	81536-5520			91536-5520	91836-5520
	FN Browning A-Bolt III long	61536-552T	71536-552T	81536-552T			91536-552T	91836-552T	
	FN Browning European	61536-5556	71536-5556	81536-5556			91536-5556	91836-5556	
	Heym SR 20	61536-5560	71536-5560	81536-5560			91536-5560	91836-5560	
	Mauser 98 (und Nachbauten)	61536-5510	71536-5510	81536-5510			91536-5510	91836-5510	
	Sauer 200	61536-5516	71536-5516	81536-5516			91536-5516	91836-5516	
	Sauer 202 Magnum	61536-5580	71536-5580	81536-5580			91536-5580	91836-5580	
	126,0 mm	Kipplaufwaffen (ohne Basen / without bases)	61536-6000	71536-6000	81536-6000	91236-6000	91436-6000	91536-6000	91836-6000
Sauer 200 Magnum		61536-6016	71536-6016	81536-6016			91536-6016	91836-6016	
Steyr M		61536-6051	71536-6051	81536-6051			91536-6051	91836-6051	
Steyr S		61536-6052	71536-6052	81536-6052			91536-6052	91836-6052	
Winchester 70 Magnum (hint. BA 8,3 mm)		61536-6025	71536-6025	81536-6025			91536-6025	91836-6025	
131,0 mm	Kipplaufwaffen (ohne Basen / without bases)	61536-6500	71536-6500	81536-6500	91236-6500	91436-6500	91536-6500	91836-6500	
	Haenel Jäger 10 (ab Serien-Nr. JX-000921)	61536-652C	71536-652C	81536-652C			91536-652C	91836-652C	
	Heym SR 21	61536-6522	71536-6522	81536-6522			91536-6522	91836-6522	
	Mauser M 96	61536-6596	71536-6596	81536-6596			91536-6596	91836-6596	
	Mauser M 96 (ab Serien-Nr. 12000)/M 97	61536-6597	71536-6597	81536-6597			91536-6597	91836-6597	
	Remington 700 long	61536-6512	71536-6512	81536-6512			91536-6512	91836-6512	
	RWS-Rößler Titan 3 / Titan 6 / Titan α	61536-6592	71536-6592	81536-6592			91536-6592	91836-6592	
	RWS-Rößler Titan 16	61536-652G	71536-652G	81536-652G			91536-652G	91836-652G	
	Sauer 80 / 90 / 92	61536-6515	71536-6515	81536-6515			91536-6515	91836-6515	
	Sauer 101	61536-652K	71536-652K	81536-652K			91536-652K	91836-652K	
	Weatherby Mark V	61536-6523	71536-6523	81536-6523			91536-6523	91836-6523	

BRÜCKENMONTAGEN mit 70° Aufnahmeprisma



One piece swing mounts with 70° dovetail attachment / Montages „Ponts“ avec prismes 70°

wahlweise mit folgenden ERAMATIC-Verschlüssen lieferbar:

Verschluss-
abstand
L

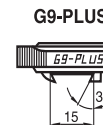
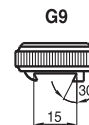
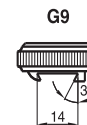
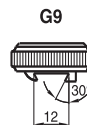
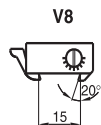
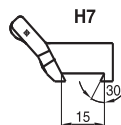
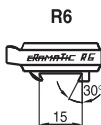

Verschluss- abstand L		R6	H7	V8	G9	G9	G9	G9-PLUS	
73,0 mm	Kipplaufwaffen (ohne Basen / without bases)	61570-1000	71570-1000	81570-1000	91270-1000	91470-1000	91570-1000	91870-1000	
	Remington 7400 / 7600 / 750	61570-1013	71570-1013	81570-1013			91570-1013	91870-1013	
93,0 mm	Kipplaufwaffen (ohne Basen / without bases)	61570-1500	71570-1500	81570-1500	91270-1500	91470-1500	91570-1500	91870-1500	
	FN Browning A-Bolt WSSM	61570-151G	71570-151G	81570-151G			91570-151G	91870-151G	
	FN Browning X-Bolt short	61570-151P	71570-151P	81570-151P			91570-151P	91870-151P	
	Sabatti Express	61570-151K	71570-151K	81570-151K			91570-151K	91870-151K	
	Steyr-Man.L (SBS 96 Export/Pro Hunter/Classic/SM12/CLII)	61570-1588	71570-1588	81570-1588			91570-1588	91870-1588	
103,0 mm	Kipplaufwaffen (ohne Basen / without bases)	61570-2000	71570-2000	81570-2000	91270-2000	91470-2000	91570-2000	91870-2000	
	FN Browning A-Bolt III short	61570-202T	71570-202T	81570-202T			91570-202T	91870-202T	
	Krico 600 / 700 / 900	61570-2006	71570-2006	81570-2006			91570-2006	91870-2006	
	Remington 783 short	61570-202S	71570-202S	81570-202S			91570-202S	91870-202S	
	Steyr-Man.M (SBS 96 Export/Pro Hunter/Classic/SM12/CLII)	61570-2088	71570-2088	81570-2088			91570-2088	91870-2088	
	Tikka T3	61570-2081	71570-2081	81570-2081			91570-2081	91870-2081	
	Winchester 70 short (hint. BA 21,9 mm)	61570-2024	71570-2024	81570-2024			91570-2024	91870-2024	
	Kipplaufwaffen (ohne Basen / without bases)	61570-2500	71570-2500	81570-2500	91270-2500	91470-2500	91570-2500	91870-2500	
109,0 mm	Benelli Argo	61570-2576	71570-2576	81570-2576			91570-2576	91870-2576	
	Brüner CZ Prisma 19,5 mm	61570-2562	71570-2562	81570-2562			91570-2562	91870-2562	
	Chapuis Express	61570-2529	71570-2529	81570-2529			91570-2529	91870-2529	
	FN Browning BAR	61570-2503	71570-2503	81570-2503			91570-2503	91870-2503	
	FN Browning Acera	61570-2577	71570-2577	81570-2577			91570-2577	91870-2577	
	FN Browning Maral	61570-252J	71570-252J	81570-252J			91570-252J	91870-252J	
	FN Browning X-Bolt long	61570-251P	71570-251P	81570-251P			91570-251P	91870-251P	
	Merkel SR1	61570-2598	71570-2598	81570-2598			91570-2598	91870-2598	
	Remington 700 short	61570-2512	71570-2512	81570-2512			91570-2512	91870-2512	
	Remington 783 long	61570-252S	71570-252S	81570-252S			91570-252S	91870-252S	
	Steyr SL	61570-2517	71570-2517	81570-2517			91570-2517	91870-2517	
	Steyr-Man.S (SBS 96 Export/Pro Hunter/Classic/SM12/CLII)	61570-2588	71570-2588	81570-2588			91570-2588	91870-2588	
	116,0 mm	Kipplaufwaffen (ohne Basen / without bases)	61570-5000	71570-5000	81570-5000	91270-5000	91470-5000	91570-5000	91870-5000
		Anschütz 1780 / 1781	61570-502B	71570-502B	81570-502B			91570-502B	91870-502B
Haenel SLB 2000+		61570-502I	71570-502I	81570-502I			91570-502I	91870-502I	
H & K SLB 2000		61570-5008	71570-5008	81570-5008			91570-5008	91870-5008	
Mauser M12		61570-502L	71570-502L	81570-502L			91570-502L	91870-502L	
Merkel SR1 Basic		61570-502D	71570-502D	81570-502D			91570-502D	91870-502D	
Sauer 202		61570-5080	71570-5080	81570-5080			91570-5080	91870-5080	
Steyr L		61570-5018	71570-5018	81570-5018			91570-5018	91870-5018	
Steyr SBS - L		61570-5087	71570-5087	81570-5087			91570-5087	91870-5087	
Swiss Arms SHR 970 (BA 21,9 mm)		61570-5040	71570-5040	81570-5040			91570-5040	91870-5040	
Verney-Carron Impact NT / Plus		61570-5047	71570-5047	81570-5047			91570-5047	91870-5047	
Winchester 70 long (hintere BA 21,9 mm)		61570-5024	71570-5024	81570-5024			91570-5024	91870-5024	
122,0 mm		Kipplaufwaffen (ohne Basen / without bases)	61570-5500	71570-5500	81570-5500	91270-5500	91470-5500	91570-5500	91870-5500
		Brüner Magnum Prisma 19,5 mm	61570-5562	71570-5562	81570-5562			91570-5562	91870-5562
	FN Browning A-Bolt	61570-5520	71570-5520	81570-5520			91570-5520	91870-5520	
	FN Browning A-Bolt III long	61570-552T	71570-552T	81570-552T			91570-552T	91870-552T	
	FN Browning European	61570-5556	71570-5556	81570-5556			91570-5556	91870-5556	
	Heym SR 20	61570-5560	71570-5560	81570-5560			91570-5560	91870-5560	
	Mauser 98 (und Nachbauten)	61570-5510	71570-5510	81570-5510			91570-5510	91870-5510	
	Sauer 200	61570-5516	71570-5516	81570-5516			91570-5516	91870-5516	
	Sauer 202 Magnum	61570-5580	71570-5580	81570-5580			91570-5580	91870-5580	
	126,0 mm	Kipplaufwaffen (ohne Basen / without bases)	61570-6000	71570-6000	81570-6000	91270-6000	91470-6000	91570-6000	91870-6000
Sauer 200 Magnum		61570-6016	71570-6016	81570-6016			91570-6016	91870-6016	
Steyr M		61570-6051	71570-6051	81570-6051			91570-6051	91870-6051	
Steyr S		61570-6052	71570-6052	81570-6052			91570-6052	91870-6052	
131,0 mm	Winchester 70 Magnum (hint. BA 8,3 mm)	61570-6025	71570-6025	81570-6025			91570-6025	91870-6025	
	Kipplaufwaffen (ohne Basen / without bases)	61570-6500	71570-6500	81570-6500	91270-6500	91470-6500	91570-6500	91870-6500	
	Haenel Jäger 10 (ab Serien-Nr. JX-000921)	61570-652C	71570-652C	81570-652C			91570-652C	91870-652C	
	Heym SR 21	61570-6522	71570-6522	81570-6522			91570-6522	91870-6522	
	Mauser M 96	61570-6596	71570-6596	81570-6596			91570-6596	91870-6596	
	Mauser M 96 (ab Serien-Nr. 12000)/M 97	61570-6597	71570-6597	81570-6597			91570-6597	91870-6597	
	Remington 700 long	61570-6512	71570-6512	81570-6512			91570-6512	91870-6512	
	RWS-Rößler Titan 3 / Titan 6 / Titan α	61570-6592	71570-6592	81570-6592			91570-6592	91870-6592	
	RWS-Rößler Titan 16	61570-652G	71570-652G	81570-652G			91570-652G	91870-652G	
	Sauer 80 / 90 / 92	61570-6515	71570-6515	81570-6515			91570-6515	91870-6515	
	Sauer 101	61570-652K	71570-652K	81570-652K			91570-652K	91870-652K	
Weatherby Mark V	61570-6523	71570-6523	81570-6523			91570-6523	91870-6523		

One piece swing mounts with 45° dovetail attachment / Montages „Ponts“ avec prismes 45°

wahlweise mit folgenden ERAMATIC-Verschlüssen lieferbar:

Verschluss-
abstand
L

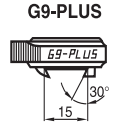
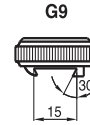
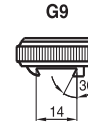
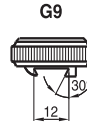
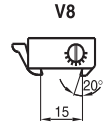
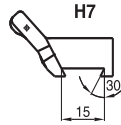
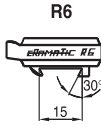

Verschluss- abstand L		R6	H7	V8	G9	G9	G9	G9-PLUS	
73,0 mm	Kipplaufwaffen (ohne Basen / without bases)	61545-1000	71545-1000	81545-1000	91245-1000	91445-1000	91545-1000	91845-1000	
	Remington 7400 / 7600 / 750	61545-1013	71545-1013	81545-1013			91545-1013	91845-1013	
93,0 mm	Kipplaufwaffen (ohne Basen / without bases)	61545-1500	71545-1500	81545-1500	91245-1500	91445-1500	91545-1500	91845-1500	
	FN Browning A-Bolt WSSM	61545-151G	71545-151G	81545-151G			91545-151G	91845-151G	
	FN Browning X-Bolt short	61545-151P	71545-151P	81545-151P			91545-151P	91845-151P	
	Sabatti Express	61545-151K	71545-151K	81545-151K			91545-151K	91845-151K	
	Steyr-Man.L (SBS 96 Export/Pro Hunter/Classic/SM12/CLII)	61545-1588	71545-1588	81545-1588			91545-1588	91845-1588	
103,0 mm	Kipplaufwaffen (ohne Basen / without bases)	61545-2000	71545-2000	81545-2000	91245-2000	91445-2000	91545-2000	91845-2000	
	FN Browning A-Bolt III short	61545-202T	71545-202T	81545-202T			91545-202T	91845-202T	
	Krico 600 / 700 / 900	61545-2006	71545-2006	81545-2006			91545-2006	91845-2006	
	Remington 783 short	61545-202S	71545-202S	81545-202S			91545-202S	91845-202S	
	Steyr-Man.M (SBS 96 Export/Pro Hunter/Classic/SM12/CLII)	61545-2088	71545-2088	81545-2088			91545-2088	91845-2088	
	Tikka T3	61545-2081	71545-2081	81545-2081			91545-2081	91845-2081	
	Winchester 70 short (hint. BA 21,9 mm)	61545-2024	71545-2024	81545-2024			91545-2024	91845-2024	
	Kipplaufwaffen (ohne Basen / without bases)	61545-2500	71545-2500	81545-2500	91245-2500	91445-2500	91545-2500	91845-2500	
109,0 mm	Benelli Argo	61545-2576	71545-2576	81545-2576			91545-2576	91845-2576	
	Brünnner CZ Prisma 19,5 mm	61545-2562	71545-2562	81545-2562			91545-2562	91845-2562	
	Chapuis Express	61545-2529	71545-2529	81545-2529			91545-2529	91845-2529	
	FN Browning BAR	61545-2503	71545-2503	81545-2503			91545-2503	91845-2503	
	FN Browning Acera	61545-2577	71545-2577	81545-2577			91545-2577	91845-2577	
	FN Browning Maral	61545-252J	71545-252J	81545-252J			91545-252J	91845-252J	
	FN Browning X-Bolt long	61545-251P	71545-251P	81545-251P			91545-251P	91845-251P	
	Merkel SR1	61545-2598	71545-2598	81545-2598			91545-2598	91845-2598	
	Remington 700 short	61545-2512	71545-2512	81545-2512			91545-2512	91845-2512	
	Remington 783 long	61545-252S	71545-252S	81545-252S			91545-252S	91845-252S	
	Steyr SL	61545-2517	71545-2517	81545-2517			91545-2517	91845-2517	
	Steyr-Man.S (SBS 96 Export/Pro Hunter/Classic/SM12/CLII)	61545-2588	71545-2588	81545-2588			91545-2588	91845-2588	
	116,0 mm	Kipplaufwaffen (ohne Basen / without bases)	61545-5000	71545-5000	81545-5000	91245-5000	91445-5000	91545-5000	91845-5000
		Anschütz 1780 / 1781	61545-502B	71545-502B	81545-502B			91545-502B	91845-502B
Haenel SLB 2000+		61545-502I	71545-502I	81545-502I			91545-502I	91845-502I	
H & K SLB 2000		61545-5008	71545-5008	81545-5008			91545-5008	91845-5008	
Mauser M12		61545-502L	71545-502L	81545-502L			91545-502L	91845-502L	
Merkel SR1 Basic		61545-502D	71545-502D	81545-502D			91545-502D	91845-502D	
Sauer 202		61545-5080	71545-5080	81545-5080			91545-5080	91845-5080	
Steyr L		61545-5018	71545-5018	81545-5018			91545-5018	91845-5018	
Steyr SBS - L		61545-5087	71545-5087	81545-5087			91545-5087	91845-5087	
Swiss Arms SHR 970 (BA 21,9 mm)		61545-5040	71545-5040	81545-5040			91545-5040	91845-5040	
Verney-Carron Impact NT / Plus		61545-5047	71545-5047	81545-5047			91545-5047	91845-5047	
Winchester 70 long (hintere BA 21,9 mm)		61545-5024	71545-5024	81545-5024			91545-5024	91845-5024	
122,0 mm		Kipplaufwaffen (ohne Basen / without bases)	61545-5500	71545-5500	81545-5500	91245-5500	91445-5500	91545-5500	91845-5500
		Brünnner Magnum Prisma 19,5 mm	61545-5562	71545-5562	81545-5562			91545-5562	91845-5562
		FN Browning A-Bolt	61545-5520	71545-5520	81545-5520			91545-5520	91845-5520
	FN Browning A-Bolt III long	61545-552T	71545-552T	81545-552T			91545-552T	91845-552T	
	FN Browning European	61545-5556	71545-5556	81545-5556			91545-5556	91845-5556	
	Heym SR 20	61545-5560	71545-5560	81545-5560			91545-5560	91845-5560	
	Mauser 98 (und Nachbauten)	61545-5510	71545-5510	81545-5510			91545-5510	91845-5510	
	Sauer 200	61545-5516	71545-5516	81545-5516			91545-5516	91845-5516	
	Sauer 202 Magnum	61545-5580	71545-5580	81545-5580			91545-5580	91845-5580	
	126,0 mm	Kipplaufwaffen (ohne Basen / without bases)	61545-6000	71545-6000	81545-6000	91245-6000	91445-6000	91545-6000	91845-6000
		Sauer 200 Magnum	61545-6016	71545-6016	81545-6016			91545-6016	91845-6016
Steyr M		61545-6051	71545-6051	81545-6051			91545-6051	91845-6051	
Steyr S		61545-6052	71545-6052	81545-6052			91545-6052	91845-6052	
Winchester 70 Magnum (hint. BA 8,3 mm)		61545-6025	71545-6025	81545-6025			91545-6025	91845-6025	
131,0 mm		Kipplaufwaffen (ohne Basen / without bases)	61545-6500	71545-6500	81545-6500	91245-6500	91445-6500	91545-6500	91845-6500
	Haenel Jäger 10 (ab Serien-Nr. JX-000921)	61545-652C	71545-652C	81545-652C			91545-652C	91845-652C	
	Heym SR 21	61545-6522	71545-6522	81545-6522			91545-6522	91845-6522	
	Mauser M 96	61545-6596	71545-6596	81545-6596			91545-6596	91845-6596	
	Mauser M 96 (ab Serien-Nr. 12000)/M 97	61545-6597	71545-6597	81545-6597			91545-6597	91845-6597	
	Remington 700 long	61545-6512	71545-6512	81545-6512			91545-6512	91845-6512	
	RWS-Rößler Titan 3 / Titan 6 / Titan α	61545-6592	71545-6592	81545-6592			91545-6592	91845-6592	
	RWS-Rößler Titan 16	61545-652G	71545-652G	81545-652G			91545-652G	91845-652G	
	Sauer 80 / 90 / 92	61545-6515	71545-6515	81545-6515			91545-6515	91845-6515	
	Sauer 101	61545-652K	71545-652K	81545-652K			91545-652K	91845-652K	
	Weatherby Mark V	61545-6523	71545-6523	81545-6523			91545-6523	91845-6523	

One piece swing mounts for Swarovski SR / Montages „Ponts“ pour Swarovski SR

wahlweise mit folgenden ERAMATIC-Verschlüssen lieferbar:

Verschluss- abstand L		wahlweise mit folgenden ERAMATIC-Verschlüssen lieferbar:							
		R6 	H7 	V8 	G9 	G9 	G9 	G9-PLUS 	
73,0 mm	Kipplaufwaffen (ohne Basen / without bases)	61553-1000	71553-1000	81553-1000	91253-1000	91453-1000	91553-1000	91853-1000	
	Remington 7400 / 7600 / 750	61553-1013	71553-1013	81553-1013			91553-1013	91853-1013	
93,0 mm	Kipplaufwaffen (ohne Basen / without bases)	61553-1500	71553-1500	81553-1500	91253-1500	91453-1500	91553-1500	91853-1500	
	FN Browning A-Bolt WSSM	61553-151G	71553-151G	81553-151G			91553-151G	91853-151G	
	FN Browning X-Bolt short	61553-151P	71553-151P	81553-151P			91553-151P	91853-151P	
	Sabatti Express	61553-151K	71553-151K	81553-151K			91553-151K	91853-151K	
	Steyr-Man.L (SBS 96 Export/Pro Hunter/Classic/SM12/CLII)	61553-1588	71553-1588	81553-1588			91553-1588	91853-1588	
103,0 mm	Kipplaufwaffen (ohne Basen / without bases)	61553-2000	71553-2000	81553-2000	91253-2000	91453-2000	91553-2000	91853-2000	
	FN Browning A-Bolt III short	61553-202T	71553-202T	81553-202T			91553-202T	91853-202T	
	Krico 600 / 700 / 900	61553-2006	71553-2006	81553-2006			91553-2006	91853-2006	
	Remington 783 short	61553-202S	71553-202S	81553-202S			91553-202S	91853-202S	
	Steyr-Man.M (SBS 96 Export/Pro Hunter/Classic/SM12/CLII)	61553-2088	71553-2088	81553-2088			91553-2088	91853-2088	
	Tikka T3	61553-2081	71553-2081	81553-2081			91553-2081	91853-2081	
	Winchester 70 short (hint. BA 21,9 mm)	61553-2024	71553-2024	81553-2024			91553-2024	91853-2024	
	Kipplaufwaffen (ohne Basen / without bases)	61553-2500	71553-2500	81553-2500	91253-2500	91453-2500	91553-2500	91853-2500	
109,0 mm	Benelli Argo	61553-2576	71553-2576	81553-2576			91553-2576	91853-2576	
	Brünnner CZ Prisma 19,5 mm	61553-2562	71553-2562	81553-2562			91553-2562	91853-2562	
	Chapuis Express	61553-2529	71553-2529	81553-2529			91553-2529	91853-2529	
	FN Browning BAR	61553-2503	71553-2503	81553-2503			91553-2503	91853-2503	
	FN Browning Acera	61553-2577	71553-2577	81553-2577			91553-2577	91853-2577	
	FN Browning Maral	61553-252J	71553-252J	81553-252J			91553-252J	91853-252J	
	FN Browning X-Bolt long	61553-251P	71553-251P	81553-251P			91553-251P	91853-251P	
	Merkel SR1	61553-2598	71553-2598	81553-2598			91553-2598	91853-2598	
	Remington 700 short	61553-2512	71553-2512	81553-2512			91553-2512	91853-2512	
	Remington 783 long	61553-252S	71553-252S	81553-252S			91553-252S	91853-252S	
	Steyr SL	61553-2517	71553-2517	81553-2517			91553-2517	91853-2517	
	Steyr-Man.S (SBS 96 Export/Pro Hunter/Classic/SM12/CLII)	61553-2588	71553-2588	81553-2588			91553-2588	91853-2588	
	116,0 mm	Kipplaufwaffen (ohne Basen / without bases)	61553-5000	71553-5000	81553-5000	91253-5000	91453-5000	91553-5000	91853-5000
		Anschütz 1780 / 1781	61553-502B	71553-502B	81553-502B			91553-502B	91853-502B
Haenel SLB 2000+		61553-502I	71553-502I	81553-502I			91553-502I	91853-502I	
H & K SLB 2000		61553-5008	71553-5008	81553-5008			91553-5008	91853-5008	
Mauser M12		61553-502L	71553-502L	81553-502L			91553-502L	91853-502L	
Merkel SR1 Basic		61553-502D	71553-502D	81553-502D			91553-502D	91853-502D	
Sauer 202		61553-5080	71553-5080	81553-5080			91553-5080	91853-5080	
Steyr L		61553-5018	71553-5018	81553-5018			91553-5018	91853-5018	
Steyr SBS - L		61553-5087	71553-5087	81553-5087			91553-5087	91853-5087	
Swiss Arms SHR 970 (BA 21,9 mm)		61553-5040	71553-5040	81553-5040			91553-5040	91853-5040	
Verney-Carron Impact NT / Plus		61553-5047	71553-5047	81553-5047			91553-5047	91853-5047	
Winchester 70 long (hintere BA 21,9 mm)		61553-5024	71553-5024	81553-5024			91553-5024	91853-5024	
122,0 mm		Kipplaufwaffen (ohne Basen / without bases)	61553-5500	71553-5500	81553-5500	91253-5500	91453-5500	91553-5500	91853-5500
		Brünnner Magnum Prisma 19,5 mm	61553-5562	71553-5562	81553-5562			91553-5562	91853-5562
		FN Browning A-Bolt	61553-5520	71553-5520	81553-5520			91553-5520	91853-5520
	FN Browning A-Bolt III long	61553-552T	71553-552T	81553-552T			91553-552T	91853-552T	
	FN Browning European	61553-5556	71553-5556	81553-5556			91553-5556	91853-5556	
	Heym SR 20	61553-5560	71553-5560	81553-5560			91553-5560	91853-5560	
	Mauser 98 (und Nachbauten)	61553-5510	71553-5510	81553-5510			91553-5510	91853-5510	
	Sauer 200	61553-5516	71553-5516	81553-5516			91553-5516	91853-5516	
	Sauer 202 Magnum	61553-5580	71553-5580	81553-5580			91553-5580	91853-5580	
	126,0 mm	Kipplaufwaffen (ohne Basen / without bases)	61553-6000	71553-6000	81553-6000	91253-6000	91453-6000	91553-6000	91853-6000
Sauer 200 Magnum		61553-6016	71553-6016	81553-6016			91553-6016	91853-6016	
Steyr M		61553-6051	71553-6051	81553-6051			91553-6051	91853-6051	
Steyr S		61553-6052	71553-6052	81553-6052			91553-6052	91853-6052	
Winchester 70 Magnum (hint. BA 8,3 mm)		61553-6025	71553-6025	81553-6025			91553-6025	91853-6025	
131,0 mm	Kipplaufwaffen (ohne Basen / without bases)	61553-6500	71553-6500	81553-6500	91253-6500	91453-6500	91553-6500	91853-6500	
	Haenel Jäger 10 (ab Serien-Nr. JX-000921)	61553-652C	71553-652C	81553-652C			91553-652C	91853-652C	
	Heym SR 21	61553-6522	71553-6522	81553-6522			91553-6522	91853-6522	
	Mauser M 96	61553-6596	71553-6596	81553-6596			91553-6596	91853-6596	
	Mauser M 96 (ab Serien-Nr. 12000)/M 97	61553-6597	71553-6597	81553-6597			91553-6597	91853-6597	
	Remington 700 long	61553-6512	71553-6512	81553-6512			91553-6512	91853-6512	
	RWS-Rößler Titan 3 / Titan 6 / Titan α	61553-6592	71553-6592	81553-6592			91553-6592	91853-6592	
	RWS-Rößler Titan 16	61553-652G	71553-652G	81553-652G			91553-652G	91853-652G	
	Sauer 80 / 90 / 92	61553-6515	71553-6515	81553-6515			91553-6515	91853-6515	
	Sauer 101	61553-652K	71553-652K	81553-652K			91553-652K	91853-652K	
	Weatherby Mark V	61553-6523	71553-6523	81553-6523			91553-6523	91853-6523	

One piece swing mounts for S&B-Convex-Rail / Montages „Ponts“ pour S&B Convex

wahlweise mit folgenden ERAMATIC-Verschlüssen lieferbar:

Verschluss- abstand L		wahlweise mit folgenden ERAMATIC-Verschlüssen lieferbar:							
		R6 	H7 	V8 	G9 	G9 	G9 	G9-PLUS 	
73,0 mm	Kipplaufwaffen (ohne Basen / without bases)	61567-1000	71567-1000	81567-1000	91267-1000	91467-1000	91567-1000	91867-1000	
	Remington 7400 / 7600 / 750	61567-1013	71567-1013	81567-1013			91567-1013	91867-1013	
93,0 mm	Kipplaufwaffen (ohne Basen / without bases)	61567-1500	71567-1500	81567-1500	91267-1500	91467-1500	91567-1500	91867-1500	
	FN Browning A-Bolt WSSM	61567-151G	71567-151G	81567-151G			91567-151G	91867-151G	
	FN Browning X-Bolt short	61567-151P	71567-151P	81567-151P			91567-151P	91867-151P	
	Sabatti Express	61567-151K	71567-151K	81567-151K			91567-151K	91867-151K	
	Steyr-Man.L (SBS 96 Export/Pro Hunter/Classic/SM12/CLII)	61567-1588	71567-1588	81567-1588			91567-1588	91867-1588	
103,0 mm	Kipplaufwaffen (ohne Basen / without bases)	61567-2000	71567-2000	81567-2000	91267-2000	91467-2000	91567-2000	91867-2000	
	FN Browning A-Bolt III short	61567-202T	71567-202T	81567-202T			91567-202T	91867-202T	
	Krico 600 / 700 / 900	61567-2006	71567-2006	81567-2006			91567-2006	91867-2006	
	Remington 783 short	61567-202S	71567-202S	81567-202S			91567-202S	91867-202S	
	Steyr-Man.M (SBS 96 Export/Pro Hunter/Classic/SM12/CLII)	61567-2088	71567-2088	81567-2088			91567-2088	91867-2088	
	Tikka T3	61567-2081	71567-2081	81567-2081			91567-2081	91867-2081	
	Winchester 70 short (hint. BA 21,9 mm)	61567-2024	71567-2024	81567-2024			91567-2024	91867-2024	
109,0 mm	Kipplaufwaffen (ohne Basen / without bases)	61567-2500	71567-2500	81567-2500	91267-2500	91467-2500	91567-2500	91867-2500	
	Benelli Argo	61567-2576	71567-2576	81567-2576			91567-2576	91867-2576	
	Brüner CZ Prisma 19,5 mm	61567-2562	71567-2562	81567-2562			91567-2562	91867-2562	
	Chapuis Express	61567-2529	71567-2529	81567-2529			91567-2529	91867-2529	
	FN Browning BAR	61567-2503	71567-2503	81567-2503			91567-2503	91867-2503	
	FN Browning Acera	61567-2577	71567-2577	81567-2577			91567-2577	91867-2577	
	FN Browning Maral	61567-252J	71567-252J	81567-252J			91567-252J	91867-252J	
	FN Browning X-Bolt long	61567-251P	71567-251P	81567-251P			91567-251P	91867-251P	
	Merkel SR1	61567-2598	71567-2598	81567-2598			91567-2598	91867-2598	
	Remington 700 short	61567-2512	71567-2512	81567-2512			91567-2512	91867-2512	
	Remington 783 long	61567-252S	71567-252S	81567-252S			91567-252S	91867-252S	
	Steyr SL	61567-2517	71567-2517	81567-2517			91567-2517	91867-2517	
	Steyr-Man.S (SBS 96 Export/Pro Hunter/Classic/SM12/CLII)	61567-2588	71567-2588	81567-2588			91567-2588	91867-2588	
	116,0 mm	Kipplaufwaffen (ohne Basen / without bases)	61567-5000	71567-5000	81567-5000	91267-5000	91467-5000	91567-5000	91867-5000
		Anschütz 1780 / 1781	61567-502B	71567-502B	81567-502B			91567-502B	91867-502B
Haenel SLB 2000+		61567-502I	71567-502I	81567-502I			91567-502I	91867-502I	
H & K SLB 2000		61567-5008	71567-5008	81567-5008			91567-5008	91867-5008	
Mauser M12		61567-502L	71567-502L	81567-502L			91567-502L	91867-502L	
Merkel SR1 Basic		61567-502D	71567-502D	81567-502D			91567-502D	91867-502D	
Sauer 202		61567-5080	71567-5080	81567-5080			91567-5080	91867-5080	
Steyr L		61567-5018	71567-5018	81567-5018			91567-5018	91867-5018	
Steyr SBS - L		61567-5087	71567-5087	81567-5087			91567-5087	91867-5087	
Swiss Arms SHR 970 (BA 21,9 mm)		61567-5040	71567-5040	81567-5040			91567-5040	91867-5040	
Verney-Carron Impact NT / Plus		61567-5047	71567-5047	81567-5047			91567-5047	91867-5047	
Winchester 70 long (hintere BA 21,9 mm)		61567-5024	71567-5024	81567-5024			91567-5024	91867-5024	
122,0 mm		Kipplaufwaffen (ohne Basen / without bases)	61567-5500	71567-5500	81567-5500	91267-5500	91467-5500	91567-5500	91867-5500
		Brüner Magnum Prisma 19,5 mm	61567-5562	71567-5562	81567-5562			91567-5562	91867-5562
		FN Browning A-Bolt	61567-5520	71567-5520	81567-5520			91567-5520	91867-5520
	FN Browning A-Bolt III long	61567-552T	71567-552T	81567-552T			91567-552T	91867-552T	
	FN Browning European	61567-5556	71567-5556	81567-5556			91567-5556	91867-5556	
	Heym SR 20	61567-5560	71567-5560	81567-5560			91567-5560	91867-5560	
	Mauser 98 (und Nachbauten)	61567-5510	71567-5510	81567-5510			91567-5510	91867-5510	
	Sauer 200	61567-5516	71567-5516	81567-5516			91567-5516	91867-5516	
	Sauer 202 Magnum	61567-5580	71567-5580	81567-5580			91567-5580	91867-5580	
	126,0 mm	Kipplaufwaffen (ohne Basen / without bases)	61567-6000	71567-6000	81567-6000	91267-6000	91467-6000	91567-6000	91867-6000
Sauer 200 Magnum		61567-6016	71567-6016	81567-6016			91567-6016	91867-6016	
Steyr M		61567-6051	71567-6051	81567-6051			91567-6051	91867-6051	
Steyr S		61567-6052	71567-6052	81567-6052			91567-6052	91867-6052	
Winchester 70 Magnum (hint. BA 8,3 mm)		61567-6025	71567-6025	81567-6025			91567-6025	91867-6025	
131,0 mm	Kipplaufwaffen (ohne Basen / without bases)	61567-6500	71567-6500	81567-6500	91267-6500	91467-6500	91567-6500	91867-6500	
	Haenel Jäger 10 (ab Serien-Nr. JX-000921)	61567-652C	71567-652C	81567-652C			91567-652C	91867-652C	
	Heym SR 21	61567-6522	71567-6522	81567-6522			91567-6522	91867-6522	
	Mauser M 96	61567-6596	71567-6596	81567-6596			91567-6596	91867-6596	
	Mauser M 96 (ab Serien-Nr. 12000)/M 97	61567-6597	71567-6597	81567-6597			91567-6597	91867-6597	
	Remington 700 long	61567-6512	71567-6512	81567-6512			91567-6512	91867-6512	
	RWS-Rößler Titan 3 / Titan 6 / Titan α	61567-6592	71567-6592	81567-6592			91567-6592	91867-6592	
	RWS-Rößler Titan 16	61567-652G	71567-652G	81567-652G			91567-652G	91867-652G	
	Sauer 80 / 90 / 92	61567-6515	71567-6515	81567-6515			91567-6515	91867-6515	
	Sauer 101	61567-652K	71567-652K	81567-652K			91567-652K	91867-652K	
	Weatherby Mark V	61567-6523	71567-6523	81567-6523			91567-6523	91867-6523	





Swing mounts for Steyr-LUXUS / Montages pivotants pour Steyr-LUXUS

Unsere ERAMATIC-Schwenkmontagen für Steyr LUXUS wurden in Zusammenarbeit mit der Firma Steyr entwickelt. Die aus Stahl und hochfestem Aluminium gefertigten Montagen sind wahlweise lieferbar mit unseren patentierten V8-, H7-, G9 sowie G9-PLUS Verschlusskörpern, die speziell für die auf der Waffe befindliche Montagesschiene ausgelegt sind. Der V8-Verschlusskörper ist selbstverriegelnd, während unser H7-Verschlusskörper mit einer im Hebel integrierten Sperrklinke versehen ist. Der G9-Verschlusskörper besitzt ein integriertes Kurvenspannsystem, ebenso wie der G9-PLUS Verschlusskörper, der mit seinem geriffelten Daumen-Nocken besonders bedienerfreundlich ist. Der Höhenausgleich wird über verdeckt einlegbare Distanzplättchen zwischen Verschlusskörper und Ring bzw. zwischen Verschlusskörper und Montagesschiene erreicht. Nacharbeiten an der Montage sind nicht notwendig. Es stehen zweiteilige Montagen mit Ringen in verschiedenen Durchmessern und Verlängerungen sowie Brückenmontagen für alle gängigen ZF mit Schiene zur Verfügung. Ebenfalls bieten wir kostengünstige Montageaufnahmen für DOCTER sight und Rotpunktvisiere mit Weaver-/Picatinny Aufnahme. Alle aus Stahl gefertigten Funktionsteile der Montage erhalten eine spezielle, von Steyr entwickelte MANNOX-Beschichtung, die zuverlässig Korrosion und Verschleiss verhindert.

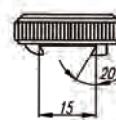
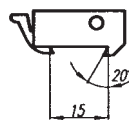
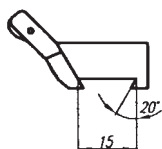
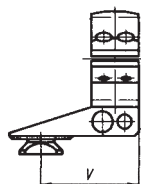

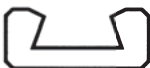
Distanzplättchen
0,1 mm 00000-5500

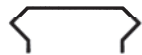
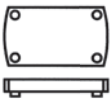

 ø 1" / 26 mm	Verlängerung V=26 mm	72615-261B	82615-261B	92615-261B	92618-261B
	Verlängerung V=45 mm	72615-451B	82615-451B	92615-451B	92618-451B
ø 30 mm	Verlängerung V=26 mm	73015-261B	83015-261B	93015-261B	93018-261B
	Verlängerung V=45 mm	73015-451B	83015-451B	93015-451B	93018-451B
ø 34 mm	Verlängerung V=26 mm	73415-261B	83415-261B	93415-261B	93418-261B
	Verlängerung V=45 mm	73415-451B	83415-451B	93415-451B	93418-451B
ø 36 mm	Verlängerung V=26 mm	73615-261B	83615-261B	93615-261B	93618-261B
	Verlängerung V=45 mm	73615-451B	83615-451B	93615-451B	93618-451B
 70°		71570-201B	81570-201B	91570-201B	91870-201B
 45°		71545-201B	81545-201B	91545-201B	91845-201B
 Swarovski SR		71553-101B	81553-101B	91553-101B	91853-101B
 S&B-Convex		71567-501B	81567-501B	91567-501B	91867-501B
 Weaver		71599-951B	81599-951B	91599-951B	91899-951B
 DOCTER sight					80450-801B

Zum Klemmen mit Rändelschraube
80450-801B

TL-Swing mounts with aluminum rings / Montages pivotants TL avec colliers aluminium

TL-Schwenkmontagen:

Eine ausgewogene Mischung aus ansprechendem Design und praktischen Vorteilen:

- Sehr niedrige Bauweise ab 10,7 mm
- Keine mechanische Nachbearbeitung bei Höhenausgleich
- Höhenausgleich-Korrektur mittels unterschiedlicher Distanzscheiben
- Fixierung von Ringen und Prismen mit Längszapfen in Verbindung mit Langloch im Verschlusskörper
- Hohe Schussfestigkeit durch kompakte Bauweise
- Garantierte Wiederholgenauigkeit beim Ein- und Ausschwenken des Zielfernrohrs
- Austauschbarkeit aller Bauteile
- Ringe aus Aluminium

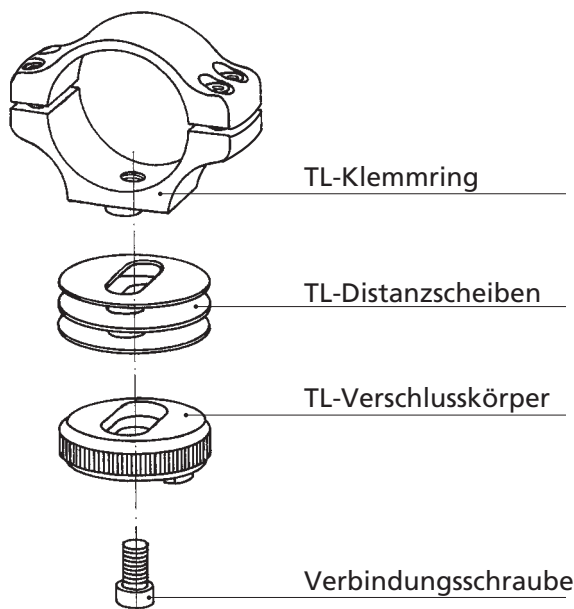
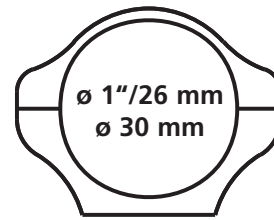

Alle Zielfernrohraufnahmen werden direkt auf den TL-Verschlusskörper aufgesetzt. Höhenausgleich-Korrekturen erfolgen mittels Distanzscheiben in verschiedenen Bauhöhen.

Anschütz	1780 / 1781
Benelli	ARGO
Brüner CZ	Prisma 16,0 mm Prisma 19,5 mm
Dakota	76 (Gewinde UNS 6-48) 76 (Gewinde UNS 8-40)
FN Browning	A-Bolt A-Bolt III A-Bolt WSSM BAR / BLR / CBL / Acera Eurobolt European Maral X-Bolt
Haenel	Jäger 10 (ab Serien-Nr. JX-000921) SLB 2000+
H & K	SLB 2000
Heym	SR 21 SR 30
Howa	1500
Krico	600 / 700 / 900 / 902
Mauser	M 94 M 96 M 96 (ab Serien-Nr. 12000) / M 97 K 98 (und Nachbauten) M12
Merkel	SR 1 SR1 Basic
Remington	700 (Gewinde UNS 6-48) 700 (Gewinde UNS 8-40) 783 7400 / 7600 / 750 Seven
RWS-Röbler	Titan 3 / Titan 6 / Titan α Titan 16
Sako	konisches Prisma / tapered dovetail
Sauer	80 / 90 / 92 101 200 202
Savage	gerundete Hülsenbrücke / rounded top
Steyr-Mannlicher	SBS-96 Export/Pro Hunter/Classic /SM12/CLII
Swiss Arms	SHR 970 (BA 21,9 mm)
Verney-Carron	Impact NT / Plus
Weatherby	Mark V / 300 / Vanguard
Winchester	70 short / long action (hint. BA 21,9 mm) 70 Magnum (Bj. n. 1964, hint. BA 8,3 mm) 100 SXR Vulcan

TL-Swing mounts with aluminum rings / Montages pivotants TL avec colliers aluminium

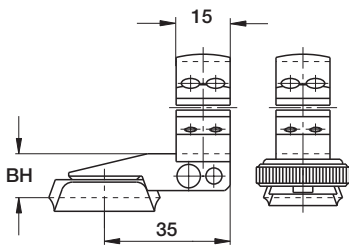

Klemmringsen aus Aluminium
 $\varnothing 1\frac{1}{2}$ mm
Verlängerung: 35 mm

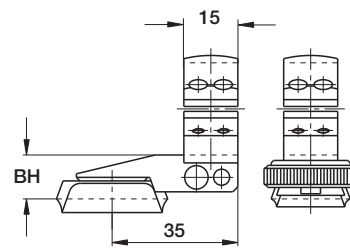

Klemmringsen aus Aluminium
 $\varnothing 30$ mm
Verlängerung: 35 mm

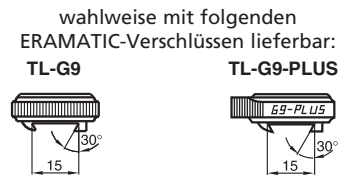
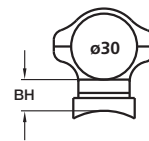
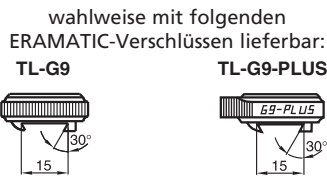
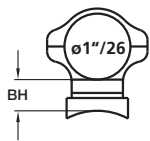

14,2 mm	92615-832B	92618-832B	14,2 mm	93015-832B	93018-832B
14,2 mm	92615-8376	92618-8376	14,2 mm	93015-8376	93018-8376
15,7 mm	92615-8361	92618-8361	15,7 mm	93015-8361	93018-8361
16,2 mm	92615-8362	92618-8362	16,2 mm	93015-8362	93018-8362
11,2 mm	92615-8307	92618-8307	11,2 mm	93015-8307	93018-8307
11,2 mm	92615-831F	92618-831F	11,2 mm	93015-831F	93018-831F
14,2 mm	92615-8320	92618-8320	14,2 mm	93015-8320	93018-8320
14,2 mm	92615-832T	92618-832T	14,2 mm	93015-832T	93018-832T
14,2 mm	92615-831G	92618-831G	14,2 mm	93015-831G	93018-831G
14,2 mm	92615-8303	92618-8303	14,2 mm	93015-8303	93018-8303
14,7 mm	92615-8378	92618-8378	14,7 mm	93015-8378	93018-8378
14,2 mm	92615-8356	92618-8356	14,2 mm	93015-8356	93018-8356
14,2 mm	92615-832J	92618-832J	14,2 mm	93015-832J	93018-832J
14,2 mm	92615-831P	92618-831P	14,2 mm	93015-831P	93018-831P
11,2 mm	92615-832C	92618-832C	11,2 mm	93015-832C	93018-832C
14,2 mm	92615-832I	92618-832I	14,2 mm	93015-832I	93018-832I
14,2 mm	92615-8308	92618-8308	14,2 mm	93015-8308	93018-8308
12,7 mm	92615-8322	92618-8322	12,7 mm	93015-8322	93018-8322
12,7 mm	92615-8390	92618-8390	12,7 mm	93015-8390	93018-8390
11,2 mm	92615-8359	92618-8359	11,2 mm	93015-8359	93018-8359
12,7 mm	92615-8306	92618-8306	12,7 mm	93015-8306	93018-8306
11,7 mm	92615-8394	92618-8394	11,7 mm	93015-8394	93018-8394
11,7 mm	92615-8396	92618-8396	11,7 mm	93015-8396	93018-8396
12,7 mm	92615-8397	92618-8397	12,7 mm	93015-8397	93018-8397
10,7 mm	92615-8310	92618-8310	10,7 mm	93015-8310	93018-8310
10,7 mm	92615-832L	92618-832L	10,7 mm	93015-832L	93018-832L
14,2 mm	92615-8398	92618-8398	14,2 mm	93015-8398	93018-8398
14,2 mm	92615-832D	92618-832D	14,2 mm	93015-832D	93018-832D
11,2 mm	92615-8312	92618-8312	11,2 mm	93015-8312	93018-8312
11,2 mm	92615-831N	92618-831N	11,2 mm	93015-831N	93018-831N
14,2 mm	92615-832S	92618-832S	14,2 mm	93015-832S	93018-832S
14,2 mm	92615-8313	92618-8313	14,2 mm	93015-8313	93018-8313
11,2 mm	92615-8319	92618-8319	11,2 mm	93015-8319	93018-8319
14,2 mm	92615-8392	92618-8392	14,2 mm	93015-8392	93018-8392
12,7 mm	92615-832G	92618-832G	12,7 mm	93015-832G	93018-832G
15,7 mm	92615-8353	92618-8353	15,7 mm	93015-8353	93018-8353
14,2 mm	92615-8315	92618-8315	14,2 mm	93015-8315	93018-8315
11,2 mm	92615-832K	92618-832K	11,2 mm	93015-832K	93018-832K
14,2 mm	92615-8316	92618-8316	14,2 mm	93015-8316	93018-8316
12,7 mm	92615-8380	92618-8380	12,7 mm	93015-8380	93018-8380
14,2 mm	92615-8393	92618-8393	14,2 mm	93015-8393	93018-8393
14,7 mm	92615-8388	92618-8388	14,7 mm	93015-8388	93018-8388
14,2 mm	92615-8340	92618-8340	14,2 mm	93015-8340	93018-8340
12,7 mm	92615-8347	92618-8347	12,7 mm	93015-8347	93018-8347
11,2 mm	92615-8323	92618-8323	11,2 mm	93015-8323	93018-8323
11,2 mm	92615-8324	92618-8324	11,2 mm	93015-8324	93018-8324
11,2 mm	92615-8325	92618-8325	11,2 mm	93015-8325	93018-8325
14,2 mm	92615-8386	92618-8386	14,2 mm	93015-8386	93018-8386
14,2 mm	92615-831J	92618-831J	14,2 mm	93015-831J	93018-831J

TL-Swing mounts with aluminum rings / Montages pivotants TL avec colliers aluminium

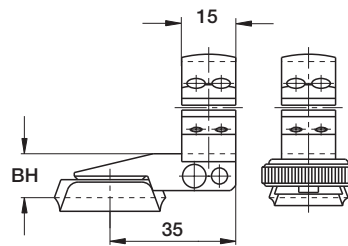
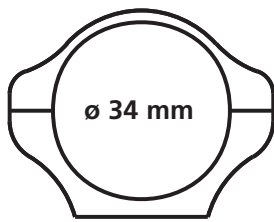

Klemmringsen
aus Aluminium
ø 34 mm
Verlängerung: 35 mm

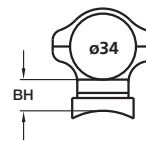

wahlweise mit folgenden
ERAMATIC-Verschlüssen lieferbar:

TL-G9

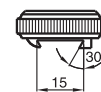

TL-G9-PLUS

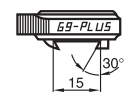

Anschütz	1780 / 1781	14,7 mm	93415-832B	93418-832B
Benelli	ARGO	14,7 mm	93415-8376	93418-8376
Brünner CZ	Prisma 16,0 mm	16,2 mm	93415-8361	93418-8361
	Prisma 19,5 mm	16,7 mm	93415-8362	93418-8362
Dakota	76 (Gewinde UNS 6-48)	11,7 mm	93415-8307	93418-8307
	76 (Gewinde UNS 8-40)	11,7 mm	93415-831F	93418-831F
FN Browning	A-Bolt	14,7 mm	93415-8320	93418-8320
	A-Bolt III	14,7 mm	93415-832T	93418-832T
	A-Bolt WSSM	14,7 mm	93415-831G	93418-831G
	BAR / BLR / CBL / Acera	14,7 mm	93415-8303	93418-8303
	Eurobolt	15,2 mm	93415-8378	93418-8378
	European	14,7 mm	93415-8356	93418-8356
	Maral	14,7 mm	93415-832J	93418-832J
	X-Bolt	14,7 mm	93415-831P	93418-831P
	Haenel	Jäger 10 (ab Serien-Nr. JX-000921)	11,7 mm	93415-832C
SLB 2000+		14,7 mm	93415-832I	93418-832I
H & K	SLB 2000	14,7 mm	93415-8308	93418-8308
Heym	SR 21	13,2 mm	93415-8322	93418-8322
	SR 30	13,2 mm	93415-8390	93418-8390
Howa	1500	11,7 mm	93415-8359	93418-8359
Krico	600 / 700 / 900 / 902	13,2 mm	93415-8306	93418-8306
Mauser	M 94	12,2 mm	93415-8394	93418-8394
	M 96	12,2 mm	93415-8396	93418-8396
	M 96 (ab Serien-Nr. 12000) / M 97	13,2 mm	93415-8397	93418-8397
	K 98 (und Nachbauten)	11,2 mm	93415-8310	93418-8310
	M12	11,2 mm	93415-832L	93418-832L
Merkel	SR 1	14,7 mm	93415-8398	93418-8398
	SR1 Basic	14,7 mm	93415-832D	93418-832D
Remington	700 (Gewinde UNS 6-48)	11,7 mm	93415-8312	93418-8312
	700 (Gewinde UNS 8-40)	11,7 mm	93415-831N	93418-831N
	783	14,7 mm	93415-832S	93418-832S
	7400 / 7600 / 750	14,7 mm	93415-8313	93418-8313
Seven		11,7 mm	93415-8319	93418-8319
RWS-Röbler	Titan 3 / Titan 6 / Titan α	14,7 mm	93415-8392	93418-8392
	Titan 16	13,2 mm	93415-832G	93418-832G
Sako	konisches Prisma / tapered dovetail	16,2 mm	93415-8353	93418-8353
Sauer	80 / 90 / 92	14,7 mm	93415-8315	93418-8315
	101	11,7 mm	93415-832K	93418-832K
	200	14,7 mm	93415-8316	93418-8316
	202	13,2 mm	93415-8380	93418-8380
Savage	gerundete Hülsenbrücke / rounded top	14,7 mm	93415-8393	93418-8393
Steyr-Mannlicher	SBS-96 Export/Pro Hunter/Classic /SM12/CLII	15,2 mm	93415-8388	93418-8388
Swiss Arms	SHR 970 (BA 21,9 mm)	14,7 mm	93415-8340	93418-8340
Verney-Carron	Impact NT / Plus	13,2 mm	93415-8347	93418-8347
Weatherby	Mark V / 300 / Vanguard	11,7 mm	93415-8323	93418-8323
Winchester	70 short / long action (hint. BA 21,9 mm)	11,7 mm	93415-8324	93418-8324
	70 Magnum (Bj. n. 1964, hint. BA 8,3 mm)	11,7 mm	93415-8325	93418-8325
	100	14,7 mm	93415-8386	93418-8386
SXR Vulcan		14,7 mm	93415-831J	93418-831J

TL-Swing mounts with aluminum rings / Montages pivotants TL avec colliers aluminium

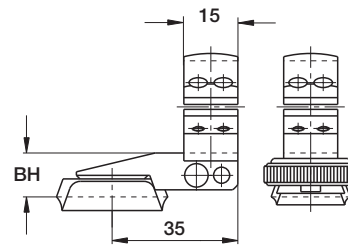
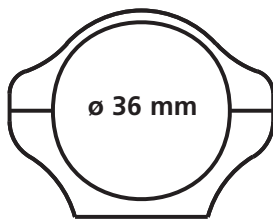

Klemmringsen aus Aluminium
ø 36 mm
Verlängerung: 35 mm

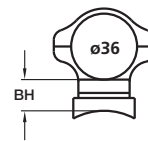

wahlweise mit folgenden ERAMATIC-Verschlässen lieferbar:

TL-G9



TL-G9-PLUS

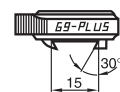

Anschütz	1780 / 1781	14,7 mm	93615-832B	93618-832B	
Benelli	ARGO	14,7 mm	93615-8376	93618-8376	
Brünnner CZ	Prisma 16,0 mm	16,2 mm	93615-8361	93618-8361	
	Prisma 19,5 mm	16,7 mm	93615-8362	93618-8362	
Dakota	76 (Gewinde UNS 6-48)	11,7 mm	93615-8307	93618-8307	
	76 (Gewinde UNS 8-40)	11,7 mm	93615-831F	93618-831F	
FN Browning	A-Bolt	14,7 mm	93615-8320	93618-8320	
	A-Bolt III	14,7 mm	93615-832T	93618-832T	
	A-Bolt WSSM	14,7 mm	93615-831G	93618-831G	
	BAR / BLR / CBL / Acera	14,7 mm	93615-8303	93618-8303	
	Eurobolt	15,2 mm	93615-8378	93618-8378	
	European	14,7 mm	93615-8356	93618-8356	
	Maral	14,7 mm	93615-832J	93618-832J	
	X-Bolt	14,7 mm	93615-831P	93618-831P	
	Haenel	Jäger 10 (ab Serien-Nr. JX-000921)	11,7 mm	93615-832C	93618-832C
		SLB 2000+	14,7 mm	93615-832I	93618-832I
H & K	SLB 2000	14,7 mm	93615-8308	93618-8308	
Heym	SR 21	13,2 mm	93615-8322	93618-8322	
	SR 30	13,2 mm	93615-8390	93618-8390	
Howa	1500	11,7 mm	93615-8359	93618-8359	
Krico	600 / 700 / 900 / 902	13,2 mm	93615-8306	93618-8306	
Mauser	M 94	12,2 mm	93615-8394	93618-8394	
	M 96	12,2 mm	93615-8396	93618-8396	
	M 96 (ab Serien-Nr. 12000) / M 97	13,2 mm	93615-8397	93618-8397	
	K 98 (und Nachbauten)	11,2 mm	93615-8310	93618-8310	
	M12	11,2 mm	93615-832L	93618-832L	
Merkel	SR 1	14,7 mm	93615-8398	93618-8398	
	SR1 Basic	14,7 mm	93615-832D	93618-832D	
Remington	700 (Gewinde UNS 6-48)	11,7 mm	93615-8312	93618-8312	
	700 (Gewinde UNS 8-40)	11,7 mm	93615-831N	93618-831N	
	783	14,7 mm	93615-832S	93618-832S	
	7400 / 7600 / 750	14,7 mm	93615-8313	93618-8313	
Seven	11,7 mm	93615-8319	93618-8319		
RWS-Röbler	Titan 3 / Titan 6 / Titan α	14,7 mm	93615-8392	93618-8392	
	Titan 16	13,2 mm	93615-832G	93618-832G	
Sako	konisches Prisma / tapered dovetail	16,2 mm	93615-8353	93618-8353	
Sauer	80 / 90 / 92	14,7 mm	93615-8315	93618-8315	
	101	11,7 mm	93615-832K	93618-832K	
	200	14,7 mm	93615-8316	93618-8316	
	202	13,2 mm	93615-8380	93618-8380	
Savage	gerundete Hülsenbrücke / rounded top	14,7 mm	93615-8393	93618-8393	
Steyr-Mannlicher	SBS-96 Export/Pro Hunter/Classic /SM12/CLII	15,2 mm	93615-8388	93618-8388	
Swiss Arms	SHR 970 (BA 21,9 mm)	14,7 mm	93615-8340	93618-8340	
Verney-Carron	Impact NT / Plus	13,2 mm	93615-8347	93618-8347	
Weatherby	Mark V / 300 / Vanguard	11,7 mm	93615-8323	93618-8323	
Winchester	70 short / long action (hint. BA 21,9 mm)	11,7 mm	93615-8324	93618-8324	
	70 Magnum (Bj. n. 1964, hint. BA 8,3 mm)	11,7 mm	93615-8325	93618-8325	
	100	14,7 mm	93615-8386	93618-8386	
	SXR Vulcan	14,7 mm	93615-831J	93618-831J	

TL-Swing mounts for scopes with contured rails / Montages pivotants TL pour lunettes rail-profil



**ZEISS
ZM/VM**
94535-84..
94538-84..



**Swarovski
SR**
95335-84..
95338-84..



S&B-Convex
96729-84..
96728-84..

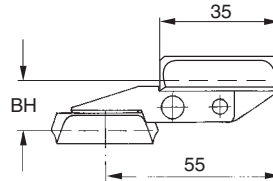

Für ZEISS-Zielfernrohre
mit ZM-/VM-Schiene
Verlängerung: 42 mm

ZEISS ZM/VM

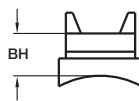

wahlweise mit folgenden
ERAMATIC-Verschlüssen lieferbar:

TL-G9



TL-G9-PLUS

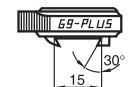

Anschütz	1780 / 1781	15,5 mm	94535-842B	94538-842B
Benelli	ARGO	15,5 mm	94535-8476	94538-8476
Brüner CZ	Prisma 16,0 mm	17,0 mm	94535-8461	94538-8461
	Prisma 19,5 mm	17,5 mm	94535-8462	94538-8462
Dakota	76 (Gewinde UNS 6-48)	13,5 mm	94535-8407	94538-8407
	76 (Gewinde UNS 8-40)	13,5 mm	94535-841F	94538-841F
FN Browning	A-Bolt	15,5 mm	94535-8420	94538-8420
	A-Bolt III	15,5 mm	94535-842T	94538-842T
	A-Bolt WSSM	15,5 mm	94535-841G	94538-841G
	BAR / BLR / CBL / Acera	15,5 mm	94535-8403	94538-8403
	Eurobolt	17,0 mm	94535-8478	94538-8478
	European	15,5 mm	94535-8456	94538-8456
	Maral	15,5 mm	94535-842J	94538-842J
	X-Bolt	15,5 mm	94535-841P	94538-841P
Haenel	Jäger 10 (ab Serien-Nr. JX-000921)	14,0 mm	94535-842C	94538-842C
	SLB 2000+	15,5 mm	94535-842I	94538-842I
H & K	SLB 2000	15,5 mm	94535-8408	94538-8408
Heym	SR 21	14,0 mm	94535-8422	94538-8422
	SR 30	14,0 mm	94535-8490	92818-8390
Howa	1500	14,0 mm	94535-8459	94538-8459
Krico	600 / 700 / 900 / 902	14,0 mm	94535-8406	94538-8406
Mauser	M 94	14,0 mm	94535-8494	94538-8494
	M 96	14,0 mm	94535-8496	94538-8496
	M 96 (ab Serien-Nr. 12000) / M 97	13,5 mm	94535-8497	94538-8497
	K 98 (und Nachbauten)	13,5 mm	94535-8410	94538-8410
	M12	13,5 mm	94535-842L	94538-842L
Merkel	SR 1	15,5 mm	94535-8498	94538-8498
	SR1 Basic	15,5 mm	94535-842D	94538-842D
Remington	700 (Gewinde UNS 6-48)	14,0 mm	94535-8412	94538-8412
	700 (Gewinde UNS 8-40)	14,0 mm	94535-841N	94538-841N
	783	15,5 mm	94535-8425	94538-8425
	7400 / 7600 / 750	15,5 mm	94535-8413	94538-8413
	Seven	14,0 mm	94535-8419	94538-8419
RWS-Rößler	Titan 3 / Titan 6 / Titan α	15,5 mm	94535-8492	94538-8492
	Titan 16	13,5 mm	94535-842G	94538-842G
Sako	konisches Prisma / tapered dovetail	17,0 mm	94535-8453	94538-8453
Sauer	80 / 90 / 92	15,5 mm	94535-8415	94538-8415
	101	14,0 mm	94535-842K	94538-842K
	200	15,5 mm	94535-8416	94538-8416
	202	14,0 mm	94535-8480	94538-8480
Savage	gerundete Hülsenbrücke / rounded top	15,5 mm	94535-8493	94538-8493
Steyr-Mannlicher	SBS-96 Export/Pro Hunter/Classic /SM12/CLII	16,0 mm	94535-8488	94518-8488
Swiss Arms	SHR 970 (BA 21,9 mm)	15,5 mm	94535-8440	94538-8440
Tikka	T3	17,0 mm	94535-8481	94538-8481
Verney-Carron	Impact NT / Plus	14,0 mm	94535-8447	94538-8447
Weatherby	Mark V / 300 / Vanguard	13,5 mm	94535-8423	94538-8423
Winchester	70 short / long action (hint. BA 21,9 mm)	13,5 mm	94535-8424	94538-8424
	70 Magnum (Bj. n. 1964, hint. BA 8,3 mm)	13,5 mm	94535-8425	94538-8425
	100	15,5 mm	94535-8486	94538-8486
	SXR Vulcan	15,5 mm	94535-841J	94538-841J

TL-Swing mounts for scopes with contoured rails / Montages pivotants TL pour lunettes rail-profil

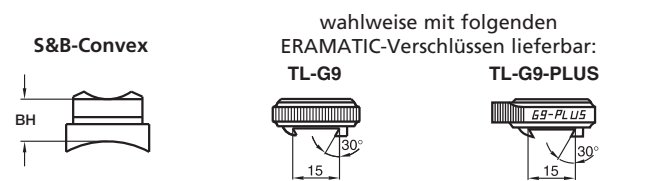
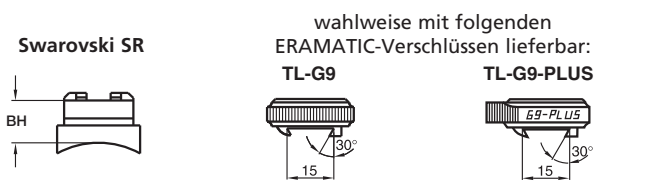
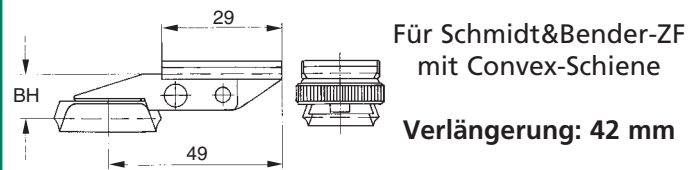
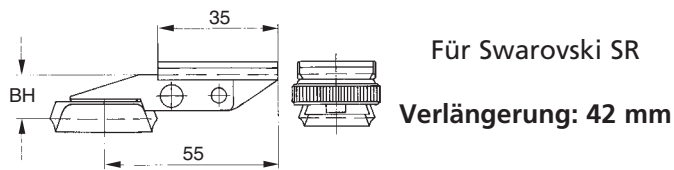

16,5 mm	95335-842B	95338-842B	15,5 mm	96729-842B	96728-842B
16,5 mm	95335-8476	95338-8476	15,5 mm	96729-8476	96728-8476
18,0 mm	95335-8461	95338-8461	17,0 mm	96729-8461	96728-8461
18,5 mm	95335-8462	95338-8462	17,5 mm	96729-8462	96728-8462
13,5 mm	95335-8407	95338-8407	13,5 mm	96729-8407	96728-8407
13,5 mm	95335-841F	95338-841F	13,5 mm	96729-841F	96728-841F
16,5 mm	95335-8420	95338-8420	15,5 mm	96729-8420	96728-8420
16,5 mm	95335-842T	95338-842T	15,5 mm	96729-842T	96728-842T
16,5 mm	95335-841G	95338-841G	15,5 mm	96729-841G	96728-841G
17,0 mm	95335-8403	95338-8403	15,5 mm	96729-8403	96728-8403
17,0 mm	95335-8478	95338-8478	17,0 mm	96729-8478	96728-8478
16,5 mm	95335-8456	95338-8456	15,5 mm	96729-8456	96728-8456
16,5 mm	95335-842J	95338-842J	15,5 mm	96729-842J	96728-842J
16,5 mm	95335-841P	95338-841P	15,5 mm	96729-841P	96728-841P
13,5 mm	95335-842C	95338-842C	14,0 mm	96729-842C	96728-842C
16,5 mm	95335-842I	95338-842I	15,5 mm	96729-842I	96728-842I
16,5 mm	95335-8408	95338-8408	15,5 mm	96729-8408	96728-8408
15,5 mm	95335-8422	95338-8422	14,0 mm	96729-8422	96728-8422
15,5 mm	95335-8490	95338-8490	14,0 mm	96729-8490	96728-8490
13,5 mm	95335-8459	95338-8459	14,0 mm	96729-8459	96728-8459
15,5 mm	95335-8406	95338-8406	14,0 mm	96729-8406	96728-8406
13,5 mm	95335-8494	95338-8494	14,0 mm	96729-8494	96728-8494
13,5 mm	95335-8496	95338-8496	14,0 mm	96729-8496	96728-8496
13,5 mm	95335-8410	95338-8410	13,5 mm	96729-8497	96728-8497
13,5 mm	95335-842L	95338-842L	13,5 mm	96729-8410	96728-8410
16,5 mm	95335-8498	95338-8498	13,5 mm	96729-842L	96728-842L
16,5 mm	95335-842D	95338-842D	15,5 mm	96729-8498	96728-8498
13,5 mm	95335-8412	95338-8412	15,5 mm	96729-842D	96728-842D
13,5 mm	95335-841N	95338-841N	14,0 mm	96729-8412	96728-8412
16,5 mm	95335-842S	95338-842S	14,0 mm	96729-841N	96728-841N
16,5 mm	95335-8413	95338-8413	15,5 mm	96729-842S	96728-842S
13,5 mm	95335-8419	95338-8419	15,5 mm	96729-8413	96728-8413
16,5 mm	95335-8492	95338-8492	15,5 mm	96729-8419	96728-8419
14,0 mm	95335-842G	95338-842G	14,0 mm	96729-8492	96728-8492
18,0 mm	95335-8453	95338-8453	13,5 mm	96729-842G	96728-842G
16,5 mm	95335-8415	95338-8415	17,0 mm	96729-8453	96728-8453
13,5 mm	95335-842K	95338-842K	17,0 mm	96729-8415	96728-8415
16,5 mm	95335-8416	95338-8416	15,5 mm	96729-842K	96728-842K
15,5 mm	95335-8480	95338-8480	14,0 mm	96729-8416	96728-8416
16,5 mm	95335-8493	95338-8493	15,5 mm	96729-8480	96728-8480
17,0 mm	95335-8488	95338-8488	15,5 mm	96729-8493	96728-8493
16,5 mm	95335-8440	95338-8440	16,0 mm	96729-8488	96728-8488
18,0 mm	95335-8481	95338-8481	15,5 mm	96729-8440	96728-8440
15,5 mm	95335-8447	95338-8447	17,0 mm	96729-8481	96728-8481
13,5 mm	95335-8423	95338-8423	12,7 mm	96729-8447	96728-8447
13,5 mm	95335-8424	95338-8424	14,0 mm	96729-8423	96728-8423
13,5 mm	95335-8425	95338-8425	13,5 mm	96729-8424	96728-8424
16,5 mm	95335-8486	95338-8486	13,5 mm	96729-8425	96728-8425
16,5 mm	95335-841J	95338-841J	15,5 mm	96729-8486	96728-8486
			15,5 mm	96729-841J	96728-841J

ERAMATIC®-SCHWENKMONTAGEN mit Stahl-Klemmringsen ø 1"/26 mm

ERAMATIC®-Swing mounts with steel rings ø 1"/26 mm

Ausführungen / Models:

- **Mögliche Verlängerungen:** ohne bzw. mit 26 mm, 31 mm, 44 mm und 56 mm
Available extensions: none (short), 26 mm, 31 mm, 44 mm and 56 mm
- **Bauhöhe / Height:** 18,5 mm
- **Ringbreite / Ring width:** 15,0 mm

Eramatic® Verschlussvarianten: Eramatic® lock-up systems:

- R6:** Verschlusskörper mit automatischer Verriegelungstechnik.
Für Prismenbasen und Schienenplatten mit 30°-Prisma.
Rotary locking system with automatic locking mechanism.
Fits all 30° rear dovetail bases and 30° rails.
- H7:** Verschlusskörper mit Entriegelungssicherung mittels Sperrklinke.
Für Prismenbasen und Schienenplatten mit 30°-Prisma.
Locking system with lever and integrated safety catch.
Fits all 30° rear dovetail bases and 30° rails.
- V8:** Verschlusskörper mit Doppelstangenverschluss.
Für Prismenbasen und Schienenplatten mit 20°-Prisma.
Locking system with self-locking clamp.
Fits all 20° rear bases and 20° rails.
- G9:** Verschlusskörper mit integriertem Kurvenspannsystem.
Für Prismenbasen und Schienenplatten mit 30°-Prisma und 15 mm Breite
sowie für 30° Laufschiene mit 12 mm und 14 mm Prismenbreite.
Rotary locking system.
Fits all 30° rear bases and 30° rails with a width of 12 mm, 14 mm or 15 mm.
- G9-Plus:** Verschlusskörper mit integriertem Kurvenspannsystem und geriffeltem
Daumennocken.
Für Prismenbasen und Schienenplatten mit 30°-Prisma und 15 mm Breite.
Rotary locking system, specially shaped for easy handling.
Fits all 30° rear bases and 30° rails with a width of 15 mm.

Swing mounts with steel rings $\varnothing 1\frac{1}{26}$ mm / Montages pivotants avec colliers $\varnothing 1\frac{1}{26}$ mm

- $\varnothing 1\frac{1}{26}$ mm
- kurze Ausführung
- Bauhöhe: 18,5 mm
- Klemmringe aus Stahl
- Ringbreite 15 mm

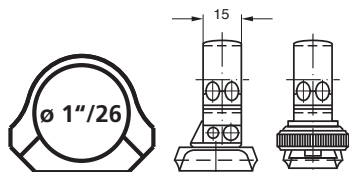

wahlweise mit folgenden ERAMATIC-Verschlüssen lieferbar:

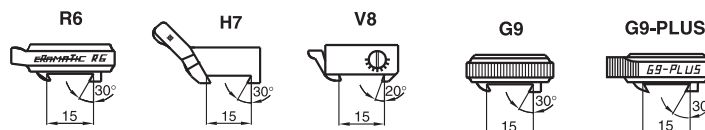

Anschütz	1780 / 1781	62615-002B	72615-002B	82615-002B	92615-002B	92618-002B
Antonio Zoli	1900	62615-0089	72615-0089	82615-0089	92615-0089	92618-0089
Benelli	ARGO	62615-0076	72615-0076	82615-0076	92615-0076	92618-0076
Beretta	689 gold sable / silver sable 2	62615-0099	72615-0099	82615-0099	92615-0099	92618-0099
Brüner CZ	Prisma 16,0 mm	62615-0061	72615-0061	82615-0061	92615-0061	92618-0061
	Prisma 19,5 mm	62615-0062	72615-0062	82615-0062	92615-0062	92618-0062
Chapuis	Express	62615-0029	72615-0029	82615-0029	92615-0029	92618-0029
Fair / Rizzini	Express	62615-0091	72615-0091	82615-0091	92615-0091	92618-0091
FN Browning	A-Bolt	62615-0020	72615-0020	82615-0020	92615-0020	92618-0020
	A-Bolt III	62615-002T	72615-002T	82615-002T	92615-002T	92618-002T
	A-Bolt WSSM	62615-001G	72615-001G	82615-001G	92615-001G	92618-001G
	BAR / BLR / CBL / Acera	62615-0003	72615-0003	82615-0003	92615-0003	92618-0003
	Eurobolt	62615-0078	72615-0078	82615-0078	92615-0078	92618-0078
	European	62615-0056	72615-0056	82615-0056	92615-0056	92618-0056
	Maral	62615-002J	72615-002J	82615-002J	92615-002J	92618-002J
	X-Bolt	62615-001P	72615-001P	82615-001P	92615-001P	92618-001P
Haenel	Jäger 10 (bis Serien-Nr. JX-000920)	62615-001W	72615-001W	82615-001W	92615-001W	92618-001W
	Jäger 10 (ab Serien-Nr. JX-000921)	62615-002C	72615-002C	82615-002C	92615-002C	92618-002C
	SLB 2000+	62615-002I	72615-002I	82615-002I	92615-002I	92618-002I
H&K	SLB 2000	62615-0008	72615-0008	82615-0008	92615-0008	92618-0008
Heym	SR 20	62615-0060	72615-0060	82615-0060	92615-0060	92618-0060
	SR 21	62615-0022	72615-0022	82615-0022	92615-0022	92618-0022
	SR 30	62615-0090	72615-0090	82615-0090	92615-0090	92618-0090
Howa	1500	62615-0059	72615-0059	82615-0059	92615-0059	92618-0059
Krico	600 / 700 / 900 / 902 Deluxe	62615-0006	72615-0006	82615-0006	92615-0006	92618-0006
Krieghoff	Semprio	62615-001C	72615-001C	82615-001C	92615-001C	92618-001C
Mauser	66	62615-0009	72615-0009	82615-0009	92615-0009	92618-0009
	M 94	62615-0094	72615-0094	82615-0094	92615-0094	92618-0094
	M 96	62615-0096	72615-0096	82615-0096	92615-0096	92618-0096
	M 96 (ab Serien-Nr. 12000) / M 97	62615-0097	72615-0097	82615-0097	92615-0097	92618-0097
	K 98 (und Nachbauten)	62615-0010	72615-0010	82615-0010	92615-0010	92618-0010
	M 12	62615-002L	72615-002L	82615-002L	92615-002L	92618-002L
Merkel	SR1	62615-0098	72615-0098	82615-0098	92615-0098	92618-0098
	SR1 Basic	62615-002D	72615-002D	82615-002D	92615-002D	92618-002D
Remington	700 (Gewinde UNS 6-48)	62615-0012	72615-0012	82615-0012	92615-0012	92618-0012
	700 (Gewinde UNS 8-40)	62615-001N	72615-001N	82615-001N	92615-001N	92618-001N
	783	62615-0025	72615-0025	82615-0025	92615-0025	92618-0025
	7400 / 7600 / 750	62615-0013	72615-0013	82615-0013	92615-0013	92618-0013
	Seven	62615-0019	72615-0019	82615-0019	92615-0019	92618-0019
RWS-Rößler	Titan 3 / Titan 6 / Titan α	62615-0092	72615-0092	82615-0092	92615-0092	92618-0092
	Titan 16	62615-002G	72615-002G	82615-002G	92615-002G	92618-002G
Sabatti	Express	62615-001K	72615-001K	82615-001K	92615-001K	92618-001K
Sako	konisches Prisma / tapered dovetail	62615-0053	72615-0053	82615-0053	92615-0053	92618-0053
Sauer	80 / 90 / 92	62615-0015	72615-0015	82615-0015	92615-0015	92618-0015
	101	62615-002K	72615-002K	82615-002K	92615-002K	92618-002K
	200	62615-0016	72615-0016	82615-0016	92615-0016	92618-0016
	202	62615-0080	72615-0080	82615-0080	92615-0080	92618-0080
Savage	ebene Hülsenbrücke / flat Top	62615-0035	72615-0035	82615-0035	92615-0035	92618-0035
	gerundete Hülsenbrücke / rounded Top	62615-0093	72615-0093	82615-0093	92615-0093	92618-0093
Steyr-Mannlicher	Luxus (siehe Katalog auf Seite 61)					
	SBS-96	62615-0087	72615-0087	82615-0087	92615-0087	92618-0087
	SBS-96 Export/Pro Hunter/Classic/SM12/CLII	62615-0088	72615-0088	82615-0088	92615-0088	92618-0088
	Mannlicher-Schönauer GK	62615-0038	72615-0038		92615-0038	92618-0038
Swiss Arms	SHR-970 (Bohrungsabstand 21,9 mm)	62615-0040	72615-0040	82615-0040	92615-0040	92618-0040
Tikka	T3	62615-0081	72615-0081	82615-0081	92615-0081	92618-0081
Verney-Carron	Impact NT / Plus	62615-0047	72615-0047	82615-0047	92615-0047	92618-0047
Voere	LBW	62615-0055	72615-0055		92615-0055	92618-0055
Weatherby	Mark V / 300 / Vanguard	62615-0023	72615-0023	82615-0023	92615-0023	92618-0023
Winchester	70 short / long action	62615-0024	72615-0024	82615-0024	92615-0024	92618-0024
	70 Magnum (Baujahr nach 1964)	62615-0025	72615-0025	82615-0025	92615-0025	92618-0025
	70 WSM	62615-0011	72615-0011	82615-0011	92615-0011	92618-0011
	70 WSSM	62615-0069	72615-0069	82615-0069	92615-0069	92618-0069
	SXR Vulcan	62615-001J	72615-001J	82615-001J	92615-001J	92618-001J
Zastava	70	62615-0001	72615-0001	82615-0001	92615-0001	92618-0001

Swing mounts with steel rings \varnothing 1"/26 mm / Montages pivotants avec colliers \varnothing 1"/26 mm

- \varnothing 1"/26 mm
- Verlängerung: 26 mm
- Bauhöhe: 18,5 mm
- Klemmringse aus Stahl
- Ringbreite 15 mm

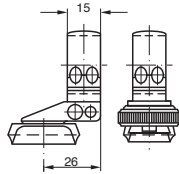

wahlweise mit folgenden ERAMATIC-Verschlüssen lieferbar:

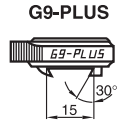
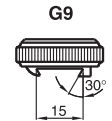
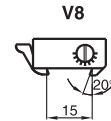
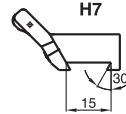
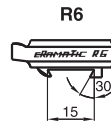

Anschütz	1780 / 1781	62615-262B	72615-262B	82615-262B	92615-262B	92618-262B
Antonio Zoli	1900	62615-2689	72615-2689	82615-2689	92615-2689	92618-2689
Benelli	ARGO	62615-2676	72615-2676	82615-2676	92615-2676	92618-2676
Beretta	689 gold sable / silver sable 2	62615-2699	72615-2699	82615-2699	92615-2699	92618-2699
Brünnner CZ	Prisma 16,0 mm	62615-2661	72615-2661	82615-2661	92615-2661	92618-2661
	Prisma 19,5 mm	62615-2662	72615-2662	82615-2662	92615-2662	92618-2662
Chapuis	Express	62615-2629	72615-2629	82615-2629	92615-2629	92618-2629
Fair / Rizzini	Express	62615-2691	72615-2691	82615-2691	92615-2691	92618-2691
FN Browning	A-Bolt	62615-2620	72615-2620	82615-2620	92615-2620	92618-2620
	A-Bolt III	62615-262T	72615-262T	82615-262T	92615-262T	92618-262T
	A-Bolt WSSM	62615-261G	72615-261G	82615-261G	92615-261G	92618-261G
	BAR / BLR / CBL / Acera	62615-2603	72615-2603	82615-2603	92615-2603	92618-2603
	Eurobolt	62615-2678	72615-2678	82615-2678	92615-2678	92618-2678
	European	62615-2656	72615-2656	82615-2656	92615-2656	92618-2656
	Maral	62615-262J	72615-262J	82615-262J	92615-262J	92618-262J
	X-Bolt	62615-261P	72615-261P	82615-261P	92615-261P	92618-261P
Haenel	Jäger 10 (bis Serien-Nr. JX-000920)	62615-261W	72615-261W	82615-261W	92615-261W	92618-261W
	Jäger 10 (ab Serien-Nr. JX-000921)	62615-262C	72615-262C	82615-262C	92615-262C	92618-262C
	SLB 2000+	62615-262I	72615-262I	82615-262I	92615-262I	92618-262I
H&K	SLB 2000	62615-2608	72615-2608	82615-2608	92615-2608	92618-2608
Heym	SR 20	62615-2660	72615-2660	82615-2660	92615-2660	92618-2660
	SR 21	62615-2622	72615-2622	82615-2622	92615-2622	92618-2622
	SR 30	62615-2690	72615-2690	82615-2690	92615-2690	92618-2690
Howa	1500	62615-2659	72615-2659	82615-2659	92615-2659	92618-2659
Krico	600 / 700 / 900 / 902 Deluxe	62615-2606	72615-2606	82615-2606	92615-2606	92618-2606
Krieghoff	Semprio	62615-261C	72615-261C	82615-261C	92615-261C	92618-261C
Mauser	66	62615-2609	72615-2609	82615-2609	92615-2609	92618-2609
	M 94	62615-2694	72615-2694	82615-2694	92615-2694	92618-2694
	M 96	62615-2696	72615-2696	82615-2696	92615-2696	92618-2696
	M 96 (ab Serien-Nr. 12000) / M 97	62615-2697	72615-2697	82615-2697	92615-2697	92618-2697
	K 98 (und Nachbauten)	62615-2610	72615-2610	82615-2610	92615-2610	92618-2610
	M 12	62615-262L	72615-262L	82615-262L	92615-262L	92618-262L
Merkel	SR1	62615-2698	72615-2698	82615-2698	92615-2698	92618-2698
	SR1 Basic	62615-262D	72615-262D	82615-262D	92615-262D	92618-262D
Remington	700 (Gewinde UNS 6-48)	62615-2612	72615-2612	82615-2612	92615-2612	92618-2612
	700 (Gewinde UNS 8-40)	62615-261N	72615-261N	82615-261N	92615-261N	92618-261N
	783	62615-2625	72615-2625	82615-2625	92615-2625	92618-2625
	7400 / 7600 / 750	62615-2613	72615-2613	82615-2613	92615-2613	92618-2613
	Seven	62615-2619	72615-2619	82615-2619	92615-2619	92618-2619
RWS-Rößler	Titan 3 / Titan 6 / Titan α	62615-2692	72615-2692	82615-2692	92615-2692	92618-2692
	Titan 16	62615-262G	72615-262G	82615-262G	92615-262G	92618-262G
Sabatti	Express	62615-261K	72615-261K	82615-261K	92615-261K	92618-261K
Sako	konisches Prisma / tapered dovetail	62615-2653	72615-2653	82615-2653	92615-2653	92618-2653
Sauer	80 / 90 / 92	62615-2615	72615-2615	82615-2615	92615-2615	92618-2615
	101	62615-262K	72615-262K	82615-262K	92615-262K	92618-262K
	200	62615-2616	72615-2616	82615-2616	92615-2616	92618-2616
	202	62615-2680	72615-2680	82615-2680	92615-2680	92618-2680
Savage	ebene Hülsenbrücke / flat Top	62615-2635	72615-2635	82615-2635	92615-2635	92618-2635
	gerundete Hülsenbrücke / rounded Top	62615-2693	72615-2693	82615-2693	92615-2693	92618-2693
Steyr-Mannlicher	Luxus (siehe Katalog auf Seite 61)					
	SBS-96	62615-2687	72615-2687	82615-2687	92615-2687	92618-2687
	SBS-96 Export/Pro Hunter/Classic/SM12/CLII	62615-2688	72615-2688	82615-2688	92615-2688	92618-2688
	Mannlicher-Schönauer GK	62615-2638	72615-2638		92615-2638	92618-2638
Swiss Arms	SHR-970 (Bohrungsabstand 21,9 mm)	62615-2640	72615-2640	82615-2640	92615-2640	92618-2640
Tikka	T3	62615-2681	72615-2681	82615-2681	92615-2681	92618-2681
Verney-Carron	Impact NT / Plus	62615-2647	72615-2647	82615-2647	92615-2647	92618-2647
Voere	LBW	62615-2655	72615-2655		92615-2655	92618-2655
Weatherby	Mark V / 300 / Vanguard	62615-2623	72615-2623	82615-2623	92615-2623	92618-2623
Winchester	70 short / long action	62615-2624	72615-2624	82615-2624	92615-2624	92618-2624
	70 Magnum (Baujahr nach 1964)	62615-2625	72615-2625	82615-2625	92615-2625	92618-2625
	70 WSM	62615-2611	72615-2611	82615-2611	92615-2611	92618-2611
	70 WSSM	62615-2669	72615-2669	82615-2669	92615-2669	92618-2669
	SXR Vulcan	62615-261J	72615-261J	82615-261J	92615-261J	92618-261J
Zastava	70	62615-2601	72615-2601	82615-2601	92615-2601	92618-2601

Swing mounts with steel rings \varnothing 1"/26 mm / Montages pivotants avec colliers \varnothing 1"/26 mm

- \varnothing 1"/26 mm
- Verlängerung: 31 mm
- Bauhöhe: 18,5 mm
- Klemmringe aus Stahl
- Ringbreite 15 mm

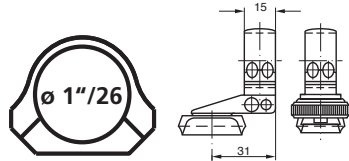

wahlweise mit folgenden ERAMATIC-Verschlüssen lieferbar:

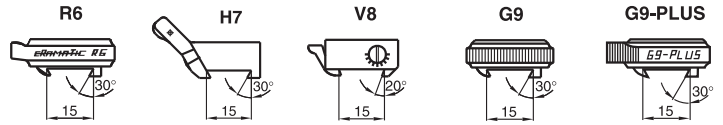

Anschütz	1780 / 1781	62615-312B	72615-312B	82615-312B	92615-312B	92618-312B
Antonio Zoli	1900	62615-3189	72615-3189	82615-3189	92615-3189	92618-3189
Benelli	ARGO	62615-3176	72615-3176	82615-3176	92615-3176	92618-3176
Beretta	689 gold sable / silver sable 2	62615-3199	72615-3199	82615-3199	92615-3199	92618-3199
Brünnner CZ	Prisma 16,0 mm	62615-3161	72615-3161	82615-3161	92615-3161	92618-3161
	Prisma 19,5 mm	62615-3162	72615-3162	82615-3162	92615-3162	92618-3162
Chapuis	Express	62615-3129	72615-3129	82615-3129	92615-3129	92618-3129
Fair / Rizzini	Express	62615-3191	72615-3191	82615-3191	92615-3191	92618-3191
FN Browning	A-Bolt	62615-3120	72615-3120	82615-3120	92615-3120	92618-3120
	A-Bolt III	62615-312T	72615-312T	82615-312T	92615-312T	92618-312T
	A-Bolt WSSM	62615-311G	72615-311G	82615-311G	92615-311G	92618-311G
	BAR / BLR / CBL / Acera	62615-3103	72615-3103	82615-3103	92615-3103	92618-3103
	Eurobolt	62615-3178	72615-3178	82615-3178	92615-3178	92618-3178
	European	62615-3156	72615-3156	82615-3156	92615-3156	92618-3156
	Maral	62615-312J	72615-312J	82615-312J	92615-312J	92618-312J
	X-Bolt	62615-311P	72615-311P	82615-311P	92615-311P	92618-311P
Haenel	Jäger 10 (bis Serien-Nr. JX-000920)	62615-311W	72615-311W	82615-311W	92615-311W	92618-311W
	Jäger 10 (ab Serien-Nr. JX-000921)	62615-312C	72615-312C	82615-312C	92615-312C	92618-312C
	SLB 2000+	62615-312I	72615-312I	82615-312I	92615-312I	92618-312I
H&K	SLB 2000	62615-3108	72615-3108	82615-3108	92615-3108	92618-3108
Heym	SR 20	62615-3160	72615-3160	82615-3160	92615-3160	92618-3160
	SR 21	62615-3122	72615-3122	82615-3122	92615-3122	92618-3122
	SR 30	62615-3190	72615-3190	82615-3190	92615-3190	92618-3190
Howa	1500	62615-3159	72615-3159	82615-3159	92615-3159	92618-3159
Krico	600 / 700 / 900 / 902 Deluxe	62615-3106	72615-3106	82615-3106	92615-3106	92618-3106
Krieghoff	Semprio	62615-311C	72615-311C	82615-311C	92615-311C	92618-311C
Mauser	66	62615-3109	72615-3109	82615-3109	92615-3109	92618-3109
	M 94	62615-3194	72615-3194	82615-3194	92615-3194	92618-3194
	M 96	62615-3196	72615-3196	82615-3196	92615-3196	92618-3196
	M 96 (ab Serien-Nr. 12000) / M 97	62615-3197	72615-3197	82615-3197	92615-3197	92618-3197
	K 98 (und Nachbauten)	62615-3110	72615-3110	82615-3110	92615-3110	92618-3110
	M 12	62615-312L	72615-312L	82615-312L	92615-312L	92618-312L
Merkel	SR1	62615-3198	72615-3198	82615-3198	92615-3198	92618-3198
	SR1 Basic	62615-312D	72615-312D	82615-312D	92615-312D	92618-312D
Remington	700 (Gewinde UNS 6-48)	62615-3112	72615-3112	82615-3112	92615-3112	92618-3112
	700 (Gewinde UNS 8-40)	62615-311N	72615-311N	82615-311N	92615-311N	92618-311N
	783	62615-3125	72615-3125	82615-3125	92615-3125	92618-3125
	7400 / 7600 / 750	62615-3113	72615-3113	82615-3113	92615-3113	92618-3113
	Seven	62615-3119	72615-3119	82615-3119	92615-3119	92618-3119
RWS-Rößler	Titan 3 / Titan 6 / Titan α	62615-3192	72615-3192	82615-3192	92615-3192	92618-3192
	Titan 16	62615-312G	72615-312G	82615-312G	92615-312G	92618-312G
Sabatti	Express	62615-311K	72615-311K	82615-311K	92615-311K	92618-311K
Sako	konisches Prisma / tapered dovetail	62615-3153	72615-3153	82615-3153	92615-3153	92618-3153
Sauer	80 / 90 / 92	62615-3115	72615-3115	82615-3115	92615-3115	92618-3115
	101	62615-312K	72615-312K	82615-312K	92615-312K	92618-312K
	200	62615-3116	72615-3116	82615-3116	92615-3116	92618-3116
	202	62615-3180	72615-3180	82615-3180	92615-3180	92618-3180
Savage	ebene Hülsenbrücke / flat Top	62615-3135	72615-3135	82615-3135	92615-3135	92618-3135
	gerundete Hülsenbrücke / rounded Top	62615-3193	72615-3193	82615-3193	92615-3193	92618-3193
Steyr-Mannlicher	Luxus (siehe Katalog auf Seite 61)					
	SBS-96	62615-3187	72615-3187	82615-3187	92615-3187	92618-3187
	SBS-96 Export/Pro Hunter/Classic/SM12/CLII	62615-3188	72615-3188	82615-3188	92615-3188	92618-3188
	Mannlicher-Schönauer GK	62615-3138	72615-3138		92615-3138	92618-3138
Swiss Arms	SHR-970 (Bohrungsabstand 21,9 mm)	62615-3140	72615-3140	82615-3140	92615-3140	92618-3140
Tikka	T3	62615-3181	72615-3181	82615-3181	92615-3181	92618-3181
Verney-Carron	Impact NT / Plus	62615-3147	72615-3147	82615-3147	92615-3147	92618-3147
Voere	LBW	62615-3155	72615-3155		92615-3155	92618-3155
Weatherby	Mark V / 300 / Vanguard	62615-3123	72615-3123	82615-3123	92615-3123	92618-3123
Winchester	70 short / long action	62615-3124	72615-3124	82615-3124	92615-3124	92618-3124
	70 Magnum (Baujahr nach 1964)	62615-3125	72615-3125	82615-3125	92615-3125	92618-3125
	70 WSM	62615-3111	72615-3111	82615-3111	92615-3111	92618-3111
	70 WSSM	62615-3169	72615-3169	82615-3169	92615-3169	92618-3169
	SXR Vulcan	62615-311J	72615-311J	82615-311J	92615-311J	92618-311J
Zastava	70	62615-3101	72615-3101	82615-3101	92615-3101	92618-3101

Swing mounts with steel rings \varnothing 1"/26 mm / Montages pivotants avec colliers \varnothing 1"/26 mm

- \varnothing 1"/26 mm
- Verlängerung: 44 mm
- Bauhöhe: 18,5 mm
- Klemmringse aus Stahl
- Ringbreite 15 mm

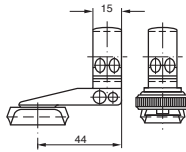

wahlweise mit folgenden ERAMATIC-Verschlüssen lieferbar:

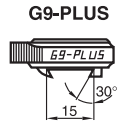
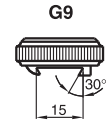
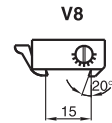
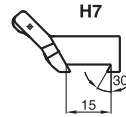
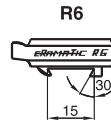

Anschütz	1780 / 1781	62615-442B	72615-442B	82615-442B	92615-442B	92618-442B
Antonio Zoli	1900	62615-4489	72615-4489	82615-4489	92615-4489	92618-4489
Benelli	ARGO	62615-4476	72615-4476	82615-4476	92615-4476	92618-4476
Beretta	689 gold sable / silver sable 2	62615-4499	72615-4499	82615-4499	92615-4499	92618-4499
Brünnner CZ	Prisma 16,0 mm	62615-4461	72615-4461	82615-4461	92615-4461	92618-4461
	Prisma 19,5 mm	62615-4462	72615-4462	82615-4462	92615-4462	92618-4462
Chapuis	Express	62615-4429	72615-4429	82615-4429	92615-4429	92618-4429
Fair / Rizzini	Express	62615-4491	72615-4491	82615-4491	92615-4491	92618-4491
FN Browning	A-Bolt	62615-4420	72615-4420	82615-4420	92615-4420	92618-4420
	A-Bolt III	62615-442T	72615-442T	82615-442T	92615-442T	92618-442T
	A-Bolt WSSM	62615-441G	72615-441G	82615-441G	92615-441G	92618-441G
	BAR / BLR / CBL / Acera	62615-4403	72615-4403	82615-4403	92615-4403	92618-4403
	Eurobolt	62615-4478	72615-4478	82615-4478	92615-4478	92618-4478
	European	62615-4456	72615-4456	82615-4456	92615-4456	92618-4456
	Maral	62615-442J	72615-442J	82615-442J	92615-442J	92618-442J
	X-Bolt	62615-441P	72615-441P	82615-441P	92615-441P	92618-441P
Haenel	Jäger 10 (bis Serien-Nr. JX-000920)	62615-441W	72615-441W	82615-441W	92615-441W	92618-441W
	Jäger 10 (ab Serien-Nr. JX-000921)	62615-442C	72615-442C	82615-442C	92615-442C	92618-442C
	SLB 2000+	62615-442I	72615-442I	82615-442I	92615-442I	92618-442I
H&K	SLB 2000	62615-4408	72615-4408	82615-4408	92615-4408	92618-4408
Heym	SR 20	62615-4460	72615-4460	82615-4460	92615-4460	92618-4460
	SR 21	62615-4422	72615-4422	82615-4422	92615-4422	92618-4422
	SR 30	62615-4490	72615-4490	82615-4490	92615-4490	92618-4490
Howa	1500	62615-4459	72615-4459	82615-4459	92615-4459	92618-4459
Krico	600 / 700 / 900 / 902 Deluxe	62615-4406	72615-4406	82615-4406	92615-4406	92618-4406
Krieghoff	Semprio	62615-441C	72615-441C	82615-441C	92615-441C	92618-441C
Mauser	66	62615-4409	72615-4409	82615-4409	92615-4409	92618-4409
	M 94	62615-4494	72615-4494	82615-4494	92615-4494	92618-4494
	M 96	62615-4496	72615-4496	82615-4496	92615-4496	92618-4496
	M 96 (ab Serien-Nr. 12000) / M 97	62615-4497	72615-4497	82615-4497	92615-4497	92618-4497
	K 98 (und Nachbauten)	62615-4410	72615-4410	82615-4410	92615-4410	92618-4410
	M 12	62615-442L	72615-442L	82615-442L	92615-442L	92618-442L
Merkel	SR1	62615-4498	72615-4498	82615-4498	92615-4498	92618-4498
	SR1 Basic	62615-442D	72615-442D	82615-442D	92615-442D	92618-442D
Remington	700 (Gewinde UNS 6-48)	62615-4412	72615-4412	82615-4412	92615-4412	92618-4412
	700 (Gewinde UNS 8-40)	62615-441N	72615-441N	82615-441N	92615-441N	92618-441N
	783	62615-442S	72615-442S	82615-442S	92615-442S	92618-442S
	7400 / 7600 / 750	62615-4413	72615-4413	82615-4413	92615-4413	92618-4413
	Seven	62615-4419	72615-4419	82615-4419	92615-4419	92618-4419
RWS-Rößler	Titan 3 / Titan 6 / Titan α	62615-4492	72615-4492	82615-4492	92615-4492	92618-4492
	Titan 16	62615-442G	72615-442G	82615-442G	92615-442G	92618-442G
Sabatti	Express	62615-441K	72615-441K	82615-441K	92615-441K	92618-441K
Sako	konisches Prisma / tapered dovetail	62615-4453	72615-4453	82615-4453	92615-4453	92618-4453
Sauer	80 / 90 / 92	62615-4415	72615-4415	82615-4415	92615-4415	92618-4415
	101	62615-442K	72615-442K	82615-442K	92615-442K	92618-442K
	200	62615-4416	72615-4416	82615-4416	92615-4416	92618-4416
	202	62615-4480	72615-4480	82615-4480	92615-4480	92618-4480
Savage	ebene Hülsenbrücke / flat Top	62615-4435	72615-4435	82615-4435	92615-4435	92618-4435
	gerundete Hülsenbrücke / rounded Top	62615-4493	72615-4493	82615-4493	92615-4493	92618-4493
Steyr-Mannlicher	Luxus (siehe Katalog auf Seite 61)					
	SBS-96	62615-4487	72615-4487	82615-4487	92615-4487	92618-4487
	SBS-96 Export/Pro Hunter/Classic/SM12/CLII	62615-4488	72615-4488	82615-4488	92615-4488	92618-4488
	Mannlicher-Schönauer GK	62615-4438	72615-4438		92615-4438	92618-4438
Swiss Arms	SHR-970 (Bohrungsabstand 21,9 mm)	62615-4440	72615-4440	82615-4440	92615-4440	92618-4440
Tikka	T3	62615-4481	72615-4481	82615-4481	92615-4481	92618-4481
Verney-Carron	Impact NT / Plus	62615-4447	72615-4447	82615-4447	92615-4447	92618-4447
Voere	LBW	62615-4455	72615-4455		92615-4455	92618-4455
Weatherby	Mark V / 300 / Vanguard	62615-4423	72615-4423	82615-4423	92615-4423	92618-4423
Winchester	70 short / long action	62615-4424	72615-4424	82615-4424	92615-4424	92618-4424
	70 Magnum (Baujahr nach 1964)	62615-4425	72615-4425	82615-4425	92615-4425	92618-4425
	70 WSM	62615-4411	72615-4411	82615-4411	92615-4411	92618-4411
	70 WSSM	62615-4469	72615-4469	82615-4469	92615-4469	92618-4469
	SXR Vulcan	62615-441J	72615-441J	82615-441J	92615-441J	92618-441J
Zastava	70	62615-4401	72615-4401	82615-4401	92615-4401	92618-4401

Swing mounts with steel rings \varnothing 1"/26 mm / Montages pivotants avec colliers \varnothing 1"/26 mm

- \varnothing 1"/26 mm
- Verlängerung: 56 mm
- Bauhöhe: 18,5 mm
- Klemmringe aus Stahl
- Ringbreite 15 mm

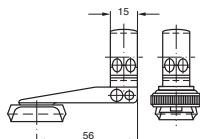

wahlweise mit folgenden ERAMATIC-Verschlüssen lieferbar:

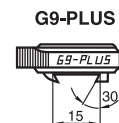
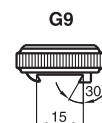
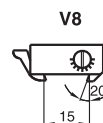
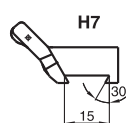
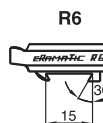

Anschütz	1780 / 1781	62615-562B	72615-562B	82615-562B	92615-562B	92618-562B
Antonio Zoli	1900	62615-5689	72615-5689	82615-5689	92615-5689	92618-5689
Benelli	ARGO	62615-5676	72615-5676	82615-5676	92615-5676	92618-5676
Beretta	689 gold sable / silver sable 2	62615-5699	72615-5699	82615-5699	92615-5699	92618-5699
Brügger CZ	Prisma 16,0 mm	62615-5661	72615-5661	82615-5661	92615-5661	92618-5661
	Prisma 19,5 mm	62615-5662	72615-5662	82615-5662	92615-5662	92618-5662
Chapuis	Express	62615-5629	72615-5629	82615-5629	92615-5629	92618-5629
Fair / Rizzini	Express	62615-5691	72615-5691	82615-5691	92615-5691	92618-5691
FN Browning	A-Bolt	62615-5620	72615-5620	82615-5620	92615-5620	92618-5620
	A-Bolt III	62615-562T	72615-562T	82615-562T	92615-562T	92618-562T
	A-Bolt WSSM	62615-561G	72615-561G	82615-561G	92615-561G	92618-561G
	BAR / BLR / CBL / Acera	62615-5603	72615-5603	82615-5603	92615-5603	92618-5603
	Eurobolt	62615-5678	72615-5678	82615-5678	92615-5678	92618-5678
	European	62615-5656	72615-5656	82615-5656	92615-5656	92618-5656
	Maral	62615-562J	72615-562J	82615-562J	92615-562J	92618-562J
	X-Bolt	62615-561P	72615-561P	82615-561P	92615-561P	92618-561P
Haenel	Jäger 10 (bis Serien-Nr. JX-000920)	62615-561W	72615-561W	82615-561W	92615-561W	92618-561W
	Jäger 10 (ab Serien-Nr. JX-000921)	62615-562C	72615-562C	82615-562C	92615-562C	92618-562C
	SLB 2000+	62615-562I	72615-562I	82615-562I	92615-562I	92618-562I
H&K	SLB 2000	62615-5608	72615-5608	82615-5608	92615-5608	92618-5608
Heym	SR 20	62615-5660	72615-5660	82615-5660	92615-5660	92618-5660
	SR 21	62615-5622	72615-5622	82615-5622	92615-5622	92618-5622
	SR 30	62615-5690	72615-5690	82615-5690	92615-5690	92618-5690
Howa	1500	62615-5659	72615-5659	82615-5659	92615-5659	92618-5659
Krico	600 / 700 / 900 / 902 Deluxe	62615-5606	72615-5606	82615-5606	92615-5606	92618-5606
Krieghoff	Semprio	62615-561C	72615-561C	82615-561C	92615-561C	92618-561C
Mauser	66	62615-5609	72615-5609	82615-5609	92615-5609	92618-5609
	M 94	62615-5694	72615-5694	82615-5694	92615-5694	92618-5694
	M 96	62615-5696	72615-5696	82615-5696	92615-5696	92618-5696
	M 96 (ab Serien-Nr. 12000) / M 97	62615-5697	72615-5697	82615-5697	92615-5697	92618-5697
	K 98 (und Nachbauten)	62615-5610	72615-5610	82615-5610	92615-5610	92618-5610
	M 12	62615-562L	72615-562L	82615-562L	92615-562L	92618-562L
Merkel	SR1	62615-5698	72615-5698	82615-5698	92615-5698	92618-5698
	SR1 Basic	62615-562D	72615-562D	82615-562D	92615-562D	92618-562D
Remington	700 (Gewinde UNS 6-48)	62615-5612	72615-5612	82615-5612	92615-5612	92618-5612
	700 (Gewinde UNS 8-40)	62615-561N	72615-561N	82615-561N	92615-561N	92618-561N
	783	62615-5625	72615-5625	82615-5625	92615-5625	92618-5625
	7400 / 7600 / 750	62615-5613	72615-5613	82615-5613	92615-5613	92618-5613
	Seven	62615-5619	72615-5619	82615-5619	92615-5619	92618-5619
RWS-Rößler	Titan 3 / Titan 6 / Titan α	62615-5692	72615-5692	82615-5692	92615-5692	92618-5692
	Titan 16	62615-562G	72615-562G	82615-562G	92615-562G	92618-562G
Sabatti	Express	62615-561K	72615-561K	82615-561K	92615-561K	92618-561K
Sako	konisches Prisma / tapered dovetail	62615-5653	72615-5653	82615-5653	92615-5653	92618-5653
Sauer	80 / 90 / 92	62615-5615	72615-5615	82615-5615	92615-5615	92618-5615
	101	62615-562K	72615-562K	82615-562K	92615-562K	92618-562K
	200	62615-5616	72615-5616	82615-5616	92615-5616	92618-5616
	202	62615-5680	72615-5680	82615-5680	92615-5680	92618-5680
Savage	ebene Hülsenbrücke / flat Top	62615-5635	72615-5635	82615-5635	92615-5635	92618-5635
	gerundete Hülsenbrücke / rounded Top	62615-5693	72615-5693	82615-5693	92615-5693	92618-5693
Steyr-Mannlicher	Luxus (siehe Katalog auf Seite 61)					
	SBS-96	62615-5687	72615-5687	82615-5687	92615-5687	92618-5687
	SBS-96 Export/Pro Hunter/Classic/SM12/CLII	62615-5688	72615-5688	82615-5688	92615-5688	92618-5688
	Mannlicher-Schönauer GK	62615-5638	72615-5638		92615-5638	92618-5638
Swiss Arms	SHR-970 (Bohrungsabstand 21,9 mm)	62615-5640	72615-5640	82615-5640	92615-5640	92618-5640
Tikka	T3	62615-5681	72615-5681	82615-5681	92615-5681	92618-5681
Verney-Carron	Impact NT / Plus	62615-5647	72615-5647	82615-5647	92615-5647	92618-5647
Voere	LBW	62615-5655	72615-5655		92615-5655	92618-5655
Weatherby	Mark V / 300 / Vanguard	62615-5623	72615-5623	82615-5623	92615-5623	92618-5623
Winchester	70 short / long action	62615-5624	72615-5624	82615-5624	92615-5624	92618-5624
	70 Magnum (Baujahr nach 1964)	62615-5625	72615-5625	82615-5625	92615-5625	92618-5625
	70 WSM	62615-5611	72615-5611	82615-5611	92615-5611	92618-5611
	70 WSSM	62615-5669	72615-5669	82615-5669	92615-5669	92618-5669
	SXR Vulcan	62615-561J	72615-561J	82615-561J	92615-561J	92618-561J
Zastava	70	62615-5601	72615-5601	82615-5601	92615-5601	92618-5601

ERAMATIC®-SCHWENKMONTAGEN mit GK-Stahl-Klemmring ø 1"/26 mm

ERAMATIC®-Swing mounts with steel rings ø 1"/26 mm

Ausführungen / Models:

- **Mögliche Verlängerungen:** ohne bzw. mit 38 mm und 56 mm
Available extensions: none (short), 38 mm and 56 mm
- **Bauhöhe / Height:** 18,5 mm
- **Ringbreiten:** vorderer Magnum-Ring 22 mm, hinterer Ring 15 mm
Ring width: front Magnum ring 22 mm, rear ring 15 mm

Eramatic® Verschlussvarianten: Eramatic® lock-up systems:

- R6:** Verschlusskörper mit automatischer Verriegelungstechnik.
Für Prismenbasen und Schienenplatten mit 30°-Prisma.
Rotary locking system with automatic locking mechanism.
Fits all 30° rear dovetail bases and 30° rails.
- H7:** Verschlusskörper mit Entriegelungssicherung mittels Sperrklinke.
Für Prismenbasen und Schienenplatten mit 30°-Prisma.
Locking system with lever and integrated safety catch.
Fits all 30° rear dovetail bases and 30° rails.
- V8:** Verschlusskörper mit Doppelstangenverschluss.
Für Prismenbasen und Schienenplatten mit 20°-Prisma.
Locking system with self-locking clamp.
Fits all 20° rear bases and 20° rails.
- G9:** Verschlusskörper mit integriertem Kurvenspannsystem.
Für Prismenbasen und Schienenplatten mit 30°-Prisma und 15 mm Breite
sowie für 30° Laufschiene mit 12 mm und 14 mm Prismenbreite.
Rotary locking system.
Fits all 30° rear bases and 30° rails with a width of 12 mm, 14 mm or 15 mm.
- G9-Plus:** Verschlusskörper mit integriertem Kurvenspannsystem und geriffeltem Daumennocken.
Für Prismenbasen und Schienenplatten mit 30°-Prisma und 15 mm Breite.
Rotary locking system, specially shaped for easy handling.
Fits all 30° rear bases and 30° rails with a width of 15 mm.

SCHWENKMONTAGEN mit GK-Klemmringsen \varnothing 1"/26 mm

Swing mounts with 22 mm large steel rings \varnothing 1"/26 mm / Montages pivotants avec colliers \varnothing 1"/26 mm, largeur 22 mm

- \varnothing 1"/26 mm
- kurze Ausführung
- Bauhöhe: 18,5 mm
- Klemmringse aus Stahl
- GK-Vorderring 22 mm breit

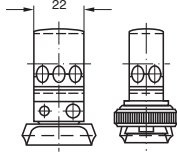

wahlweise mit folgenden ERAMATIC-Verschlüssen lieferbar:

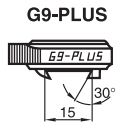
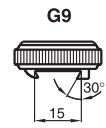
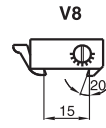
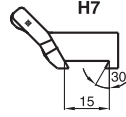
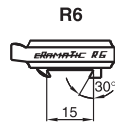

Anschütz	1780 / 1781	62622-002B	72622-002B	82622-002B	92622-002B	92628-002B
Antonio Zoli	1900	62622-0089	72622-0089	82622-0089	92622-0089	92628-0089
Benelli	ARGO	62622-0076	72622-0076	82622-0076	92622-0076	92628-0076
Beretta	689 gold sable / silver sable 2	62622-0099	72622-0099	82622-0099	92622-0099	92628-0099
Brünnner CZ	Prisma 16,0 mm	62622-0061	72622-0061	82622-0061	92622-0061	92628-0061
	Prisma 19,5 mm	62622-0062	72622-0062	82622-0062	92622-0062	92628-0062
Chapuis	Express	62622-0029	72622-0029	82622-0029	92622-0029	92628-0029
Fair / Rizzini	Express	62622-0091	72622-0091	82622-0091	92622-0091	92628-0091
FN Browning	A-Bolt	62622-0020	72622-0020	82622-0020	92622-0020	92628-0020
	A-Bolt III	62622-002T	72622-002T	82622-002T	92622-002T	92628-002T
	A-Bolt WSSM	62622-001G	72622-001G	82622-001G	92622-001G	92628-001G
	BAR / BLR / CBL / Acera	62622-0003	72622-0003	82622-0003	92622-0003	92628-0003
	Eurobolt	62622-0078	72622-0078	82622-0078	92622-0078	92628-0078
	European	62622-0056	72622-0056	82622-0056	92622-0056	92628-0056
	Maral	62622-002J	72622-002J	82622-002J	92622-002J	92628-002J
	X-Bolt	62622-001P	72622-001P	82622-001P	92622-001P	92628-001P
Haenel	Jäger 10 (bis Serien-Nr. JX-000920)	62622-001W	72622-001W	82622-001W	92622-001W	92628-001W
	Jäger 10 (ab Serien-Nr. JX-000921)	62622-002C	72622-002C	82622-002C	92622-002C	92628-002C
	SLB 2000+	62622-002I	72622-002I	82622-002I	92622-002I	92628-002I
H&K	SLB 2000	62622-0008	72622-0008	82622-0008	92622-0008	92628-0008
Heym	SR 20	62622-0060	72622-0060	82622-0060	92622-0060	92628-0060
	SR 21	62622-0022	72622-0022	82622-0022	92622-0022	92628-0022
	SR 30	62622-0090	72622-0090	82622-0090	92622-0090	92628-0090
Howa	1500	62622-0059	72622-0059	82622-0059	92622-0059	92628-0059
Krico	600 / 700 / 900 / 902 Deluxe	62622-0006	72622-0006	82622-0006	92622-0006	92628-0006
Krieghoff	Semprio	62622-001C	72622-001C	82622-001C	92622-001C	92628-001C
Mauser	66	62622-0009	72622-0009	82622-0009	92622-0009	92628-0009
	M 94	62622-0094	72622-0094	82622-0094	92622-0094	92628-0094
	M 96	62622-0096	72622-0096	82622-0096	92622-0096	92628-0096
	M 96 (ab Serien-Nr. 12000) / M 97	62622-0097	72622-0097	82622-0097	92622-0097	92628-0097
	K 98 (und Nachbauten)	62622-0010	72622-0010	82622-0010	92622-0010	92628-0010
	M 12	62622-002L	72622-002L	82622-002L	92622-002L	92628-002L
Merkel	SR1	62622-0098	72622-0098	82622-0098	92622-0098	92628-0098
	SR1 Basic	62622-002D	72622-002D	82622-002D	92622-002D	92628-002D
Remington	700 (Gewinde UNS 6-48)	62622-0012	72622-0012	82622-0012	92622-0012	92628-0012
	700 (Gewinde UNS 8-40)	62622-001N	72622-001N	82622-001N	92622-001N	92628-001N
	783	62622-0025	72622-0025	82622-0025	92622-0025	92628-0025
	7400 / 7600 / 750	62622-0013	72622-0013	82622-0013	92622-0013	92628-0013
	Seven	62622-0019	72622-0019	82622-0019	92622-0019	92628-0019
RWS-Rößler	Titan 3 / Titan 6 / Titan α	62622-0092	72622-0092	82622-0092	92622-0092	92628-0092
	Titan 16	62622-002G	72622-002G	82622-002G	92622-002G	92628-002G
Sabatti	Express	62622-001K	72622-001K	82622-001K	92622-001K	92628-001K
Sako	konisches Prisma / tapered dovetail	62622-0053	72622-0053	82622-0053	92622-0053	92628-0053
Sauer	80 / 90 / 92	62622-0015	72622-0015	82622-0015	92622-0015	92628-0015
	101	62622-002K	72622-002K	82622-002K	92622-002K	92628-002K
	200	62622-0016	72622-0016	82622-0016	92622-0016	92628-0016
	202	62622-0080	72622-0080	82622-0080	92622-0080	92628-0080
Savage	ebene Hülsenbrücke / flat Top	62622-0035	72622-0035	82622-0035	92622-0035	92628-0035
	gerundete Hülsenbrücke / rounded Top	62622-0093	72622-0093	82622-0093	92622-0093	92628-0093
Steyr-Mannlicher	Luxus (siehe Katalog auf Seite 61)					
	SBS-96	62622-0087	72622-0087	82622-0087	92622-0087	92628-0087
	SBS-96 Export/Pro Hunter/Classic/SM12/CLII	62622-0088	72622-0088	82622-0088	92622-0088	92628-0088
	Mannlicher-Schönauer GK	62622-0038	72622-0038		92622-0038	92628-0038
Swiss Arms	SHR-970 (Bohrungsabstand 21,9 mm)	62622-0040	72622-0040	82622-0040	92622-0040	92628-0040
Tikka	T3	62622-0081	72622-0081	82622-0081	92622-0081	92628-0081
Verney-Carron	Impact NT / Plus	62622-0047	72622-0047	82622-0047	92622-0047	92628-0047
Voere	LBW	62622-0055	72622-0055		92622-0055	92628-0055
Weatherby	Mark V / 300 / Vanguard	62622-0023	72622-0023	82622-0023	92622-0023	92628-0023
Winchester	70 short / long action	62622-0024	72622-0024	82622-0024	92622-0024	92628-0024
	70 Magnum (Baujahr nach 1964)	62622-0025	72622-0025	82622-0025	92622-0025	92628-0025
	70 WSM	62622-0011	72622-0011	82622-0011	92622-0011	92628-0011
	70 WSSM	62622-0069	72622-0069	82622-0069	92622-0069	92628-0069
	SXR Vulcan	62622-001J	72622-001J	82622-001J	92622-001J	92628-001J
Zastava	70	62622-0001	72622-0001	82622-0001	92622-0001	92628-0001

Swing mounts with 22 mm large steel rings $\varnothing 1\frac{1}{26}$ mm / Montages pivotants avec colliers $\varnothing 1\frac{1}{26}$ mm, largeur 22 mm

- $\varnothing 1\frac{1}{26}$ mm
- Verlängerung 38 mm
- Bauhöhe: 18,5 mm
- Klemmringse aus Stahl
- GK-Vorderring 22 mm breit

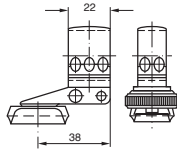

wahlweise mit folgenden ERAMATIC-Verschlüssen lieferbar:

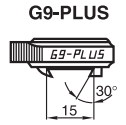
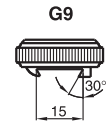
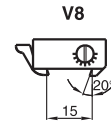
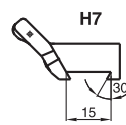
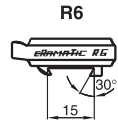

Anschütz	1780 / 1781	62622-382B	72622-382B	82622-382B	92622-382B	92628-382B
Antonio Zoli	1900	62622-3889	72622-3889	82622-3889	92622-3889	92628-3889
Benelli	ARGO	62622-3876	72622-3876	82622-3876	92622-3876	92628-3876
Beretta	689 gold sable / silver sable 2	62622-3899	72622-3899	82622-3899	92622-3899	92628-3899
Brünnner CZ	Prisma 16,0 mm	62622-3861	72622-3861	82622-3861	92622-3861	92628-3861
	Prisma 19,5 mm	62622-3862	72622-3862	82622-3862	92622-3862	92628-3862
Chapuis	Express	62622-3829	72622-3829	82622-3829	92622-3829	92628-3829
Fair / Rizzini	Express	62622-3891	72622-3891	82622-3891	92622-3891	92628-3891
FN Browning	A-Bolt	62622-3820	72622-3820	82622-3820	92622-3820	92628-3820
	A-Bolt III	62622-382T	72622-382T	82622-382T	92622-382T	92628-382T
	A-Bolt WSSM	62622-381G	72622-381G	82622-381G	92622-381G	92628-381G
	BAR / BLR / CBL / Acera	62622-3803	72622-3803	82622-3803	92622-3803	92628-3803
	Eurobolt	62622-3878	72622-3878	82622-3878	92622-3878	92628-3878
	European	62622-3856	72622-3856	82622-3856	92622-3856	92628-3856
	Maral	62622-382J	72622-382J	82622-382J	92622-382J	92628-382J
	X-Bolt	62622-381P	72622-381P	82622-381P	92622-381P	92628-381P
Haenel	Jäger 10 (bis Serien-Nr. JX-000920)	62622-381W	72622-381W	82622-381W	92622-381W	92628-381W
	Jäger 10 (ab Serien-Nr. JX-000921)	62622-382C	72622-382C	82622-382C	92622-382C	92628-382C
	SLB 2000+	62622-382I	72622-382I	82622-382I	92622-382I	92628-382I
H&K	SLB 2000	62622-3808	72622-3808	82622-3808	92622-3808	92628-3808
Heym	SR 20	62622-3860	72622-3860	82622-3860	92622-3860	92628-3860
	SR 21	62622-3822	72622-3822	82622-3822	92622-3822	92628-3822
	SR 30	62622-3890	72622-3890	82622-3890	92622-3890	92628-3890
Howa	1500	62622-3859	72622-3859	82622-3859	92622-3859	92628-3859
Krico	600 / 700 / 900 / 902 Deluxe	62622-3806	72622-3806	82622-3806	92622-3806	92628-3806
Krieghoff	Semprio	62622-381C	72622-381C	82622-381C	92622-381C	92628-381C
Mauser	66	62622-3809	72622-3809	82622-3809	92622-3809	92628-3809
	M 94	62622-3894	72622-3894	82622-3894	92622-3894	92628-3894
	M 96	62622-3896	72622-3896	82622-3896	92622-3896	92628-3896
	M 96 (ab Serien-Nr. 12000) / M 97	62622-3897	72622-3897	82622-3897	92622-3897	92628-3897
	K 98 (und Nachbauten)	62622-3810	72622-3810	82622-3810	92622-3810	92628-3810
	M 12	62622-382L	72622-382L	82622-382L	92622-382L	92628-382L
Merkel	SR1	62622-3898	72622-3898	82622-3898	92622-3898	92628-3898
	SR1 Basic	62622-382D	72622-382D	82622-382D	92622-382D	92628-382D
Remington	700 (Gewinde UNS 6-48)	62622-3812	72622-3812	82622-3812	92622-3812	92628-3812
	700 (Gewinde UNS 8-40)	62622-381N	72622-381N	82622-381N	92622-381N	92628-381N
	783	62622-3825	72622-3825	82622-3825	92622-3825	92628-3825
	7400 / 7600 / 750	62622-3813	72622-3813	82622-3813	92622-3813	92628-3813
	Seven	62622-3819	72622-3819	82622-3819	92622-3819	92628-3819
RWS-Rößler	Titan 3 / Titan 6 / Titan α	62622-3892	72622-3892	82622-3892	92622-3892	92628-3892
	Titan 16	62622-382G	72622-382G	82622-382G	92622-382G	92628-382G
Sabatti	Express	62622-381K	72622-381K	82622-381K	92622-381K	92628-381K
Sako	konisches Prisma / tapered dovetail	62622-3853	72622-3853	82622-3853	92622-3853	92628-3853
Sauer	80 / 90 / 92	62622-3815	72622-3815	82622-3815	92622-3815	92628-3815
	101	62622-382K	72622-382K	82622-382K	92622-382K	92628-382K
	200	62622-3816	72622-3816	82622-3816	92622-3816	92628-3816
	202	62622-3880	72622-3880	82622-3880	92622-3880	92628-3880
Savage	ebene Hülsenbrücke / flat Top	62622-3835	72622-3835	82622-3835	92622-3835	92628-3835
	gerundete Hülsenbrücke / rounded Top	62622-3893	72622-3893	82622-3893	92622-3893	92628-3893
Steyr-Mannlicher	Luxus (siehe Katalog auf Seite 61)					
	SBS-96	62622-3887	72622-3887	82622-3887	92622-3887	92628-3887
	SBS-96 Export/Pro Hunter/Classic/SM12/CLII	62622-3888	72622-3888	82622-3888	92622-3888	92628-3888
	Mannlicher-Schönauer GK	62622-3838	72622-3838		92622-3838	92628-3838
Swiss Arms	SHR-970 (Bohrungsabstand 21,9 mm)	62622-3840	72622-3840	82622-3840	92622-3840	92628-3840
Tikka	T3	62622-3881	72622-3881	82622-3881	92622-3881	92628-3881
Verney-Carron	Impact NT / Plus	62622-3847	72622-3847	82622-3847	92622-3847	92628-3847
Voere	LBW	62622-3855	72622-3855		92622-3855	92628-3855
Weatherby	Mark V / 300 / Vanguard	62622-3823	72622-3823	82622-3823	92622-3823	92628-3823
Winchester	70 short / long action	62622-3824	72622-3824	82622-3824	92622-3824	92628-3824
	70 Magnum (Baujahr nach 1964)	62622-3825	72622-3825	82622-3825	92622-3825	92628-3825
	70 WSM	62622-3811	72622-3811	82622-3811	92622-3811	92628-3811
	70 WSSM	62622-3869	72622-3869	82622-3869	92622-3869	92628-3869
	SXR Vulcan	62622-381J	72622-381J	82622-381J	92622-381J	92628-381J
Zastava	70	62622-3801	72622-3801	82622-3801	92622-3801	92628-3801

Swing mounts with 22 mm large steel rings \varnothing 1"/26 mm / Montages pivotants avec colliers \varnothing 1"/26 mm, largeur 22 mm

- \varnothing 1"/26 mm
- Verlängerung 56 mm
- Bauhöhe: 18,5 mm
- Klemmringse aus Stahl
- GK-Vorderring 22 mm breit

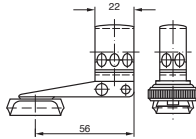

wahlweise mit folgenden ERAMATIC-Verschlüssen lieferbar:

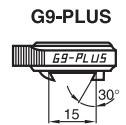
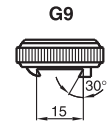
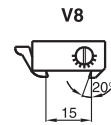
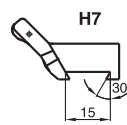
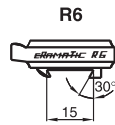

Anschütz	1780 / 1781	62622-562B	72622-562B	82622-562B	92622-562B	92628-562B
Antonio Zoli	1900	62622-5689	72622-5689	82622-5689	92622-5689	92628-5689
Benelli	ARGO	62622-5676	72622-5676	82622-5676	92622-5676	92628-5676
Beretta	689 gold sable / silver sable 2	62622-5699	72622-5699	82622-5699	92622-5699	92628-5699
Brünnner CZ	Prisma 16,0 mm	62622-5661	72622-5661	82622-5661	92622-5661	92628-5661
	Prisma 19,5 mm	62622-5662	72622-5662	82622-5662	92622-5662	92628-5662
Chapuis	Express	62622-5629	72622-5629	82622-5629	92622-5629	92628-5629
Fair / Rizzini	Express	62622-5691	72622-5691	82622-5691	92622-5691	92628-5691
FN Browning	A-Bolt	62622-5620	72622-5620	82622-5620	92622-5620	92628-5620
	A-Bolt III	62622-562T	72622-562T	82622-562T	92622-562T	92628-562T
	A-Bolt WSSM	62622-561G	72622-561G	82622-561G	92622-561G	92628-561G
	BAR / BLR / CBL / Acera	62622-5603	72622-5603	82622-5603	92622-5603	92628-5603
	Eurobolt	62622-5678	72622-5678	82622-5678	92622-5678	92628-5678
	European	62622-5656	72622-5656	82622-5656	92622-5656	92628-5656
	Maral	62622-562J	72622-562J	82622-562J	92622-562J	92628-562J
	X-Bolt	62622-561P	72622-561P	82622-561P	92622-561P	92628-561P
Haenel	Jäger 10 (bis Serien-Nr. JX-000920)	62622-561W	72622-561W	82622-561W	92622-561W	92628-561W
	Jäger 10 (ab Serien-Nr. JX-000921)	62622-562C	72622-562C	82622-562C	92622-562C	92628-562C
	SLB 2000+	62622-562I	72622-562I	82622-562I	92622-562I	92628-562I
H&K	SLB 2000	62622-5608	72622-5608	82622-5608	92622-5608	92628-5608
Heym	SR 20	62622-5660	72622-5660	82622-5660	92622-5660	92628-5660
	SR 21	62622-5622	72622-5622	82622-5622	92622-5622	92628-5622
	SR 30	62622-5690	72622-5690	82622-5690	92622-5690	92628-5690
Howa	1500	62622-5659	72622-5659	82622-5659	92622-5659	92628-5659
Krico	600 / 700 / 900 / 902 Deluxe	62622-5606	72622-5606	82622-5606	92622-5606	92628-5606
Krieghoff	Semprio	62622-561C	72622-561C	82622-561C	92622-561C	92628-561C
Mauser	66	62622-5609	72622-5609	82622-5609	92622-5609	92628-5609
	M 94	62622-5694	72622-5694	82622-5694	92622-5694	92628-5694
	M 96	62622-5696	72622-5696	82622-5696	92622-5696	92628-5696
	M 96 (ab Serien-Nr. 12000) / M 97	62622-5697	72622-5697	82622-5697	92622-5697	92628-5697
	K 98 (und Nachbauten)	62622-5610	72622-5610	82622-5610	92622-5610	92628-5610
	M 12	62622-562L	72622-562L	82622-562L	92622-562L	92628-562L
Merkel	SR1	62622-5698	72622-5698	82622-5698	92622-5698	92628-5698
	SR1 Basic	62622-562D	72622-562D	82622-562D	92622-562D	92628-562D
Remington	700 (Gewinde UNS 6-48)	62622-5612	72622-5612	82622-5612	92622-5612	92628-5612
	700 (Gewinde UNS 8-40)	62622-561N	72622-561N	82622-561N	92622-561N	92628-561N
	783	62622-5625	72622-5625	82622-5625	92622-5625	92628-5625
	7400 / 7600 / 750	62622-5613	72622-5613	82622-5613	92622-5613	92628-5613
	Seven	62622-5619	72622-5619	82622-5619	92622-5619	92628-5619
RWS-Rößler	Titan 3 / Titan 6 / Titan α	62622-5692	72622-5692	82622-5692	92622-5692	92628-5692
	Titan 16	62622-562G	72622-562G	82622-562G	92622-562G	92628-562G
Sabatti	Express	62622-561K	72622-561K	82622-561K	92622-561K	92628-561K
Sako	konisches Prisma / tapered dovetail	62622-5653	72622-5653	82622-5653	92622-5653	92628-5653
Sauer	80 / 90 / 92	62622-5615	72622-5615	82622-5615	92622-5615	92628-5615
	101	62622-562K	72622-562K	82622-562K	92622-562K	92628-562K
	200	62622-5616	72622-5616	82622-5616	92622-5616	92628-5616
	202	62622-5680	72622-5680	82622-5680	92622-5680	92628-5680
Savage	ebene Hülsenbrücke / flat Top	62622-5635	72622-5635	82622-5635	92622-5635	92628-5635
	gerundete Hülsenbrücke / rounded Top	62622-5693	72622-5693	82622-5693	92622-5693	92628-5693
Steyr-Mannlicher	Luxus (siehe Katalog auf Seite 61)					
	SBS-96	62622-5687	72622-5687	82622-5687	92622-5687	92628-5687
	SBS-96 Export/Pro Hunter/Classic/SM12/CLII	62622-5688	72622-5688	82622-5688	92622-5688	92628-5688
	Mannlicher-Schönauer GK	62622-5638	72622-5638		92622-5638	92628-5638
Swiss Arms	SHR-970 (Bohrungsabstand 21,9 mm)	62622-5640	72622-5640	82622-5640	92622-5640	92628-5640
Tikka	T3	62622-5681	72622-5681	82622-5681	92622-5681	92628-5681
Verney-Carron	Impact NT / Plus	62622-5647	72622-5647	82622-5647	92622-5647	92628-5647
Voere	LBW	62622-5655	72622-5655		92622-5655	92628-5655
Weatherby	Mark V / 300 / Vanguard	62622-5623	72622-5623	82622-5623	92622-5623	92628-5623
Winchester	70 short / long action	62622-5624	72622-5624	82622-5624	92622-5624	92628-5624
	70 Magnum (Baujahr nach 1964)	62622-5625	72622-5625	82622-5625	92622-5625	92628-5625
	70 WSM	62622-5611	72622-5611	82622-5611	92622-5611	92628-5611
	70 WSSM	62622-5669	72622-5669	82622-5669	92622-5669	92628-5669
	SXR Vulcan	62622-561J	72622-561J	82622-561J	92622-561J	92628-561J
Zastava	70	62622-5601	72622-5601	82622-5601	92622-5601	92628-5601

ERAMATIC®-SCHWENKMONTAGEN mit Light-Klemmringsen ø 1"/26 mm

ERAMATIC®-Swing mounts with aluminium rings ø 1"/26 mm

Ausführungen / Models:

- **Mögliche Verlängerungen:** ohne bzw. mit 26 mm, 31 mm, 44 mm und 56 mm
Available extensions: none (short), 26 mm, 31 mm, 44 mm and 56 mm
- **Bauhöhe / Height:** 18,5 mm
- **Ringbreite / Ring width:** 15,0 mm

Eramatic® Verschlussvarianten: Eramatic® lock-up systems:

- R6:** Verschlusskörper mit automatischer Verriegelungstechnik.
Für Prismenbasen und Schienenplatten mit 30°-Prisma.
Rotary locking system with automatic locking mechanism.
Fits all 30° rear dovetail bases and 30° rails.
- H7:** Verschlusskörper mit Entriegelungssicherung mittels Sperrklinke.
Für Prismenbasen und Schienenplatten mit 30°-Prisma.
Locking system with lever and integrated safety catch.
Fits all 30° rear dovetail bases and 30° rails.
- V8:** Verschlusskörper mit Doppelstangenverschluss.
Für Prismenbasen und Schienenplatten mit 20°-Prisma.
Locking system with self-locking clamp.
Fits all 20° rear bases and 20° rails.
- G9:** Verschlusskörper mit integriertem Kurvenspannsystem.
Für Prismenbasen und Schienenplatten mit 30°-Prisma und 15 mm Breite
sowie für 30° Laufschiene mit 12 mm und 14 mm Prismenbreite.
Rotary locking system.
Fits all 30° rear bases and 30° rails with a width of 12 mm, 14 mm or 15 mm.
- G9-Plus:** Verschlusskörper mit integriertem Kurvenspannsystem und geriffeltem Daumennocken.
Für Prismenbasen und Schienenplatten mit 30°-Prisma und 15 mm Breite.
Rotary locking system, specially shaped for easy handling.
Fits all 30° rear bases and 30° rails with a width of 15 mm.

Swing mounts with aluminum rings \varnothing 1"/26 mm / Montages pivotants avec colliers alu. \varnothing 1"/26 mm

- \varnothing 1"/26 mm
- kurze Ausführung
- Bauhöhe: 18,5 mm
- Klemmringse aus Aluminium
- Ringbreite 15 mm

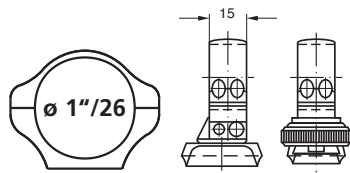

wahlweise mit folgenden ERAMATIC-Verschlüssen lieferbar:

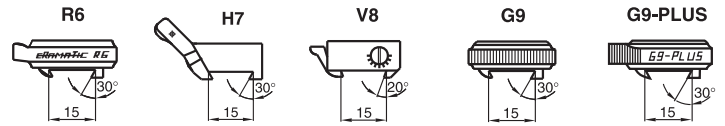

Anschütz	1780 / 1781	62415-002B	72415-002B	82415-002B	92415-002B	92418-002B
Antonio Zoli	1900	62415-0089	72415-0089	82415-0089	92415-0089	92418-0089
Benelli	ARGO	62415-0076	72415-0076	82415-0076	92415-0076	92418-0076
Beretta	689 gold sable / silver sable 2	62415-0099	72415-0099	82415-0099	92415-0099	92418-0099
Brünnner CZ	Prisma 16,0 mm	62415-0061	72415-0061	82415-0061	92415-0061	92418-0061
	Prisma 19,5 mm	62415-0062	72415-0062	82415-0062	92415-0062	92418-0062
Chapuis	Express	62415-0029	72415-0029	82415-0029	92415-0029	92418-0029
Fair / Rizzini	Express	62415-0091	72415-0091	82415-0091	92415-0091	92418-0091
FN Browning	A-Bolt	62415-0020	72415-0020	82415-0020	92415-0020	92418-0020
	A-Bolt III	62415-002T	72415-002T	82415-002T	92415-002T	92418-002T
	A-Bolt WSSM	62415-001G	72415-001G	82415-001G	92415-001G	92418-001G
	BAR / BLR / CBL / Acera	62415-0003	72415-0003	82415-0003	92415-0003	92418-0003
	Eurobolt	62415-0078	72415-0078	82415-0078	92415-0078	92418-0078
	European	62415-0056	72415-0056	82415-0056	92415-0056	92418-0056
	Maral	62415-002J	72415-002J	82415-002J	92415-002J	92418-002J
	X-Bolt	62415-001P	72415-001P	82415-001P	92415-001P	92418-001P
Haenel	Jäger 10 (bis Serien-Nr. JX-000920)	62415-001W	72415-001W	82415-001W	92415-001W	92418-001W
	Jäger 10 (ab Serien-Nr. JX-000921)	62415-002C	72415-002C	82415-002C	92415-002C	92418-002C
	SLB 2000+	62415-002I	72415-002I	82415-002I	92415-002I	92418-002I
H&K	SLB 2000	62415-0008	72415-0008	82415-0008	92415-0008	92418-0008
Heym	SR 20	62415-0060	72415-0060	82415-0060	92415-0060	92418-0060
	SR 21	62415-0022	72415-0022	82415-0022	92415-0022	92418-0022
	SR 30	62415-0090	72415-0090	82415-0090	92415-0090	92418-0090
Howa	1500	62415-0059	72415-0059	82415-0059	92415-0059	92418-0059
Krico	600 / 700 / 900 / 902 Deluxe	62415-0006	72415-0006	82415-0006	92415-0006	92418-0006
Krieghoff	Semprio	62415-001C	72415-001C	82415-001C	92415-001C	92418-001C
Mauser	66	62415-0009	72415-0009	82415-0009	92415-0009	92418-0009
	M 94	62415-0094	72415-0094	82415-0094	92415-0094	92418-0094
	M 96	62415-0096	72415-0096	82415-0096	92415-0096	92418-0096
	M 96 (ab Serien-Nr. 12000) / M 97	62415-0097	72415-0097	82415-0097	92415-0097	92418-0097
	K 98 (und Nachbauten)	62415-0010	72415-0010	82415-0010	92415-0010	92418-0010
	M 12	62415-002L	72415-002L	82415-002L	92415-002L	92418-002L
Merkel	SR1	62415-0098	72415-0098	82415-0098	92415-0098	92418-0098
	SR1 Basic	62415-002D	72415-002D	82415-002D	92415-002D	92418-002D
Remington	700 (Gewinde UNS 6-48)	62415-0012	72415-0012	82415-0012	92415-0012	92418-0012
	700 (Gewinde UNS 8-40)	62415-001N	72415-001N	82415-001N	92415-001N	92418-001N
	783	62415-0025	72415-0025	82415-0025	92415-0025	92418-0025
	7400 / 7600 / 750	62415-0013	72415-0013	82415-0013	92415-0013	92418-0013
	Seven	62415-0019	72415-0019	82415-0019	92415-0019	92418-0019
RWS-Rößler	Titan 3 / Titan 6 / Titan α	62415-0092	72415-0092	82415-0092	92415-0092	92418-0092
	Titan 16	62415-002G	72415-002G	82415-002G	92415-002G	92418-002G
Sabatti	Express	62415-001K	72415-001K	82415-001K	92415-001K	92418-001K
Sako	konisches Prisma / tapered dovetail	62415-0053	72415-0053	82415-0053	92415-0053	92418-0053
Sauer	80 / 90 / 92	62415-0015	72415-0015	82415-0015	92415-0015	92418-0015
	101	62415-002K	72415-002K	82415-002K	92415-002K	92418-002K
	200	62415-0016	72415-0016	82415-0016	92415-0016	92418-0016
	202	62415-0080	72415-0080	82415-0080	92415-0080	92418-0080
Savage	ebene Hülsenbrücke / flat Top	62415-0035	72415-0035	82415-0035	92415-0035	92418-0035
	gerundete Hülsenbrücke / rounded Top	62415-0093	72415-0093	82415-0093	92415-0093	92418-0093
Steyr-Mannlicher	Luxus (siehe Katalog auf Seite 61)					
	SBS-96	62415-0087	72415-0087	82415-0087	92415-0087	92418-0087
	SBS-96 Export/Pro Hunter/Classic/SM12/CLII	62415-0088	72415-0088	82415-0088	92415-0088	92418-0088
Swiss Arms	SHR-970 (Bohrungsabstand 21,9 mm)	62415-0040	72415-0040	82415-0040	92415-0040	92418-0040
Tikka	T3	62415-0081	72415-0081	82415-0081	92415-0081	92418-0081
Verney-Carron	Impact NT / Plus	62415-0047	72415-0047	82415-0047	92415-0047	92418-0047
Voere	LBW	62415-0055	72415-0055	82415-0055	92415-0055	92418-0055
Weatherby	Mark V / 300 / Vanguard	62415-0023	72415-0023	82415-0023	92415-0023	92418-0023
Winchester	70 short / long action	62415-0024	72415-0024	82415-0024	92415-0024	92418-0024
	70 Magnum (Baujahr nach 1964)	62415-0025	72415-0025	82415-0025	92415-0025	92418-0025
	70 WSM	62415-0011	72415-0011	82415-0011	92415-0011	92418-0011
	70 WSSM	62415-0069	72415-0069	82415-0069	92415-0069	92418-0069
	SXR Vulcan	62415-001J	72415-001J	82415-001J	92415-001J	92418-001J
Zastava	70	62415-0001	72415-0001	82415-0001	92415-0001	92418-0001

Swing mounts with aluminum rings \varnothing 1"/26 mm / Montages pivotants avec colliers alu. \varnothing 1"/26 mm

- \varnothing 1"/26 mm
- Verlängerung 26 mm
- Bauhöhe: 18,5 mm
- Klemmringse aus Aluminium
- Ringbreite 15 mm

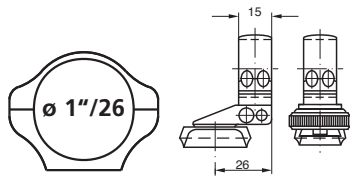

wahlweise mit folgenden ERAMATIC-Verschlüssen lieferbar:

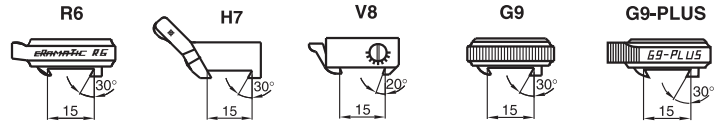

Anschütz	1780 / 1781	62415-262B	72415-262B	82415-262B	92415-262B	92418-262B
Antonio Zoli	1900	62415-2689	72415-2689	82415-2689	92415-2689	92418-2689
Benelli	ARGO	62415-2676	72415-2676	82415-2676	92415-2676	92418-2676
Beretta	689 gold sable / silver sable 2	62415-2699	72415-2699	82415-2699	92415-2699	92418-2699
Brünnner CZ	Prisma 16,0 mm	62415-2661	72415-2661	82415-2661	92415-2661	92418-2661
	Prisma 19,5 mm	62415-2662	72415-2662	82415-2662	92415-2662	92418-2662
Chapuis	Express	62415-2629	72415-2629	82415-2629	92415-2629	92418-2629
Fair / Rizzini	Express	62415-2691	72415-2691	82415-2691	92415-2691	92418-2691
FN Browning	A-Bolt	62415-2620	72415-2620	82415-2620	92415-2620	92418-2620
	A-Bolt III	62415-262T	72415-262T	82415-262T	92415-262T	92418-262T
	A-Bolt WSSM	62415-261G	72415-261G	82415-261G	92415-261G	92418-261G
	BAR / BLR / CBL / Acera	62415-2603	72415-2603	82415-2603	92415-2603	92418-2603
	Eurobolt	62415-2678	72415-2678	82415-2678	92415-2678	92418-2678
	European	62415-2656	72415-2656	82415-2656	92415-2656	92418-2656
	Maral	62415-262J	72415-262J	82415-262J	92415-262J	92418-262J
	X-Bolt	62415-261P	72415-261P	82415-261P	92415-261P	92418-261P
Haenel	Jäger 10 (bis Serien-Nr. JX-000920)	62415-261W	72415-261W	82415-261W	92415-261W	92418-261W
	Jäger 10 (ab Serien-Nr. JX-000921)	62415-262C	72415-262C	82415-262C	92415-262C	92418-262C
	SLB 2000+	62415-262I	72415-262I	82415-262I	92415-262I	92418-262I
H&K	SLB 2000	62415-2608	72415-2608	82415-2608	92415-2608	92418-2608
Heym	SR 20	62415-2660	72415-2660	82415-2660	92415-2660	92418-2660
	SR 21	62415-2622	72415-2622	82415-2622	92415-2622	92418-2622
	SR 30	62415-2690	72415-2690	82415-2690	92415-2690	92418-2690
Howa	1500	62415-2659	72415-2659	82415-2659	92415-2659	92418-2659
Krico	600 / 700 / 900 / 902 Deluxe	62415-2606	72415-2606	82415-2606	92415-2606	92418-2606
Krieghoff	Semprio	62415-261C	72415-261C	82415-261C	92415-261C	92418-261C
Mauser	66	62415-2609	72415-2609	82415-2609	92415-2609	92418-2609
	M 94	62415-2694	72415-2694	82415-2694	92415-2694	92418-2694
	M 96	62415-2696	72415-2696	82415-2696	92415-2696	92418-2696
	M 96 (ab Serien-Nr. 12000) / M 97	62415-2697	72415-2697	82415-2697	92415-2697	92418-2697
	K 98 (und Nachbauten)	62415-2610	72415-2610	82415-2610	92415-2610	92418-2610
	M 12	62415-262L	72415-262L	82415-262L	92415-262L	92418-262L
Merkel	SR1	62415-2698	72415-2698	82415-2698	92415-2698	92418-2698
	SR1 Basic	62415-262D	72415-262D	82415-262D	92415-262D	92418-262D
Remington	700 (Gewinde UNS 6-48)	62415-2612	72415-2612	82415-2612	92415-2612	92418-2612
	700 (Gewinde UNS 8-40)	62415-261N	72415-261N	82415-261N	92415-261N	92418-261N
	783	62415-2625	72415-2625	82415-2625	92415-2625	92418-2625
	7400 / 7600 / 750	62415-2613	72415-2613	82415-2613	92415-2613	92418-2613
	Seven	62415-2619	72415-2619	82415-2619	92415-2619	92418-2619
RWS-Rößler	Titan 3 / Titan 6 / Titan α	62415-2692	72415-2692	82415-2692	92415-2692	92418-2692
	Titan 16	62415-262G	72415-262G	82415-262G	92415-262G	92418-262G
Sabatti	Express	62415-261K	72415-261K	82415-261K	92415-261K	92418-261K
Sako	konisches Prisma / tapered dovetail	62415-2653	72415-2653	82415-2653	92415-2653	92418-2653
Sauer	80 / 90 / 92	62415-2615	72415-2615	82415-2615	92415-2615	92418-2615
	101	62415-262K	72415-262K	82415-262K	92415-262K	92418-262K
	200	62415-2616	72415-2616	82415-2616	92415-2616	92418-2616
	202	62415-2680	72415-2680	82415-2680	92415-2680	92418-2680
Savage	ebene Hülsenbrücke / flat Top	62415-2635	72415-2635	82415-2635	92415-2635	92418-2635
	gerundete Hülsenbrücke / rounded Top	62415-2693	72415-2693	82415-2693	92415-2693	92418-2693
Steyr-Mannlicher	Luxus (siehe Katalog auf Seite 61)					
	SBS-96	62415-2687	72415-2687	82415-2687	92415-2687	92418-2687
	SBS-96 Export/Pro Hunter/Classic/SM12/CLII	62415-2688	72415-2688	82415-2688	92415-2688	92418-2688
Swiss Arms	SHR-970 (Bohrungsabstand 21,9 mm)	62415-2640	72415-2640	82415-2640	92415-2640	92418-2640
Tikka	T3	62415-2681	72415-2681	82415-2681	92415-2681	92418-2681
Verney-Carron	Impact NT / Plus	62415-2647	72415-2647	82415-2647	92415-2647	92418-2647
Voere	LBW	62415-2655	72415-2655	82415-2655	92415-2655	92418-2655
Weatherby	Mark V / 300 / Vanguard	62415-2623	72415-2623	82415-2623	92415-2623	92418-2623
Winchester	70 short / long action	62415-2624	72415-2624	82415-2624	92415-2624	92418-2624
	70 Magnum (Baujahr nach 1964)	62415-2625	72415-2625	82415-2625	92415-2625	92418-2625
	70 WSM	62415-2611	72415-2611	82415-2611	92415-2611	92418-2611
	70 WSSM	62415-2669	72415-2669	82415-2669	92415-2669	92418-2669
	SXR Vulcan	62415-261J	72415-261J	82415-261J	92415-261J	92418-261J
Zastava	70	62415-2601	72415-2601	82415-2601	92415-2601	92418-2601

Swing mounts with aluminum rings \varnothing 1"/26 mm / Montages pivotants avec colliers alu. \varnothing 1"/26 mm

- \varnothing 1"/26 mm
- Verlängerung 31 mm
- Bauhöhe: 18,5 mm
- Klemmringse aus Aluminium
- Ringbreite 15 mm

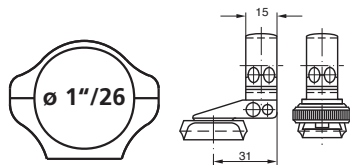

wahlweise mit folgenden ERAMATIC-Verschlüssen lieferbar:

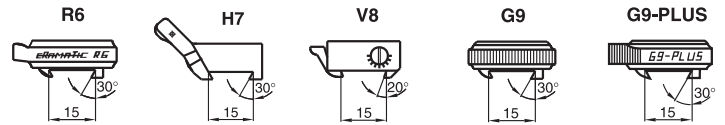

Anschütz	1780 / 1781	62415-312B	72415-312B	82415-312B	92415-312B	92418-312B
Antonio Zoli	1900	62415-3189	72415-3189	82415-3189	92415-3189	92418-3189
Benelli	ARGO	62415-3176	72415-3176	82415-3176	92415-3176	92418-3176
Beretta	689 gold sable / silver sable 2	62415-3199	72415-3199	82415-3199	92415-3199	92418-3199
Brünnner CZ	Prisma 16,0 mm	62415-3161	72415-3161	82415-3161	92415-3161	92418-3161
	Prisma 19,5 mm	62415-3162	72415-3162	82415-3162	92415-3162	92418-3162
Chapuis	Express	62415-3129	72415-3129	82415-3129	92415-3129	92418-3129
Fair / Rizzini	Express	62415-3191	72415-3191	82415-3191	92415-3191	92418-3191
FN Browning	A-Bolt	62415-3120	72415-3120	82415-3120	92415-3120	92418-3120
	A-Bolt III	62415-312T	72415-312T	82415-312T	92415-312T	92418-312T
	A-Bolt WSSM	62415-311G	72415-311G	82415-311G	92415-311G	92418-311G
	BAR / BLR / CBL / Acera	62415-3103	72415-3103	82415-3103	92415-3103	92418-3103
	Eurobolt	62415-3178	72415-3178	82415-3178	92415-3178	92418-3178
	European	62415-3156	72415-3156	82415-3156	92415-3156	92418-3156
	Maral	62415-312J	72415-312J	82415-312J	92415-312J	92418-312J
	X-Bolt	62415-311P	72415-311P	82415-311P	92415-311P	92418-311P
Haenel	Jäger 10 (bis Serien-Nr. JX-000920)	62415-311W	72415-311W	82415-311W	92415-311W	92418-311W
	Jäger 10 (ab Serien-Nr. JX-000921)	62415-312C	72415-312C	82415-312C	92415-312C	92418-312C
	SLB 2000+	62415-312I	72415-312I	82415-312I	92415-312I	92418-312I
H&K	SLB 2000	62415-3108	72415-3108	82415-3108	92415-3108	92418-3108
Heym	SR 20	62415-3160	72415-3160	82415-3160	92415-3160	92418-3160
	SR 21	62415-3122	72415-3122	82415-3122	92415-3122	92418-3122
	SR 30	62415-3190	72415-3190	82415-3190	92415-3190	92418-3190
Howa	1500	62415-3159	72415-3159	82415-3159	92415-3159	92418-3159
Krico	600 / 700 / 900 / 902 Deluxe	62415-3106	72415-3106	82415-3106	92415-3106	92418-3106
Krieghoff	Semprio	62415-311C	72415-311C	82415-311C	92415-311C	92418-311C
Mauser	66	62415-3109	72415-3109	82415-3109	92415-3109	92418-3109
	M 94	62415-3194	72415-3194	82415-3194	92415-3194	92418-3194
	M 96	62415-3196	72415-3196	82415-3196	92415-3196	92418-3196
	M 96 (ab Serien-Nr. 12000) / M 97	62415-3197	72415-3197	82415-3197	92415-3197	92418-3197
	K 98 (und Nachbauten)	62415-3110	72415-3110	82415-3110	92415-3110	92418-3110
	M 12	62415-312L	72415-312L	82415-312L	92415-312L	92418-312L
Merkel	SR1	62415-3198	72415-3198	82415-3198	92415-3198	92418-3198
	SR1 Basic	62415-312D	72415-312D	82415-312D	92415-312D	92418-312D
Remington	700 (Gewinde UNS 6-48)	62415-3112	72415-3112	82415-3112	92415-3112	92418-3112
	700 (Gewinde UNS 8-40)	62415-311N	72415-311N	82415-311N	92415-311N	92418-311N
	783	62415-3125	72415-3125	82415-3125	92415-3125	92418-3125
	7400 / 7600 / 750	62415-3113	72415-3113	82415-3113	92415-3113	92418-3113
	Seven	62415-3119	72415-3119	82415-3119	92415-3119	92418-3119
RWS-Rößler	Titan 3 / Titan 6 / Titan α	62415-3192	72415-3192	82415-3192	92415-3192	92418-3192
	Titan 16	62415-312G	72415-312G	82415-312G	92415-312G	92418-312G
Sabatti	Express	62415-311K	72415-311K	82415-311K	92415-311K	92418-311K
Sako	konisches Prisma / tapered dovetail	62415-3153	72415-3153	82415-3153	92415-3153	92418-3153
Sauer	80 / 90 / 92	62415-3115	72415-3115	82415-3115	92415-3115	92418-3115
	101	62415-312K	72415-312K	82415-312K	92415-312K	92418-312K
	200	62415-3116	72415-3116	82415-3116	92415-3116	92418-3116
	202	62415-3180	72415-3180	82415-3180	92415-3180	92418-3180
Savage	ebene Hülsenbrücke / flat Top	62415-3135	72415-3135	82415-3135	92415-3135	92418-3135
	gerundete Hülsenbrücke / rounded Top	62415-3193	72415-3193	82415-3193	92415-3193	92418-3193
Steyr-Mannlicher	Luxus (siehe Katalog auf Seite 61)					
	SBS-96	62415-3187	72415-3187	82415-3187	92415-3187	92418-3187
	SBS-96 Export/Pro Hunter/Classic/SM12/CLII	62415-3188	72415-3188	82415-3188	92415-3188	92418-3188
Swiss Arms	SHR-970 (Bohrungsabstand 21,9 mm)	62415-3140	72415-3140	82415-3140	92415-3140	92418-3140
Tikka	T3	62415-3181	72415-3181	82415-3181	92415-3181	92418-3181
Verney-Carron	Impact NT / Plus	62415-3147	72415-3147	82415-3147	92415-3147	92418-3147
Voere	LBW	62415-3155	72415-3155	82415-3155	92415-3155	92418-3155
Weatherby	Mark V / 300 / Vanguard	62415-3123	72415-3123	82415-3123	92415-3123	92418-3123
Winchester	70 short / long action	62415-3124	72415-3124	82415-3124	92415-3124	92418-3124
	70 Magnum (Baujahr nach 1964)	62415-3125	72415-3125	82415-3125	92415-3125	92418-3125
	70 WSM	62415-3111	72415-3111	82415-3111	92415-3111	92418-3111
	70 WSSM	62415-3169	72415-3169	82415-3169	92415-3169	92418-3169
	SXR Vulcan	62415-311J	72415-311J	82415-311J	92415-311J	92418-311J
Zastava	70	62415-3101	72415-3101	82415-3101	92415-3101	92418-3101

Swing mounts with aluminum rings ø 1"/26 mm / Montages pivotants avec colliers alu. ø 1"/26 mm

- ø 1"/26 mm
- Verlängerung 44 mm
- Bauhöhe: 18,5 mm
- Klemmrings aus Aluminium
- Ringbreite 15 mm

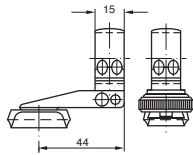
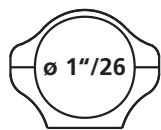

wahlweise mit folgenden ERAMATIC-Verschlüssen lieferbar:

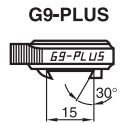
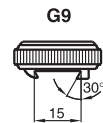
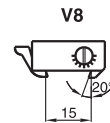
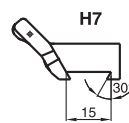
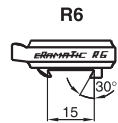

Anschütz	1780 / 1781	62415-442B	72415-442B	82415-442B	92415-442B	92418-442B
Antonio Zoli	1900	62415-4489	72415-4489	82415-4489	92415-4489	92418-4489
Benelli	ARGO	62415-4476	72415-4476	82415-4476	92415-4476	92418-4476
Beretta	689 gold sable / silver sable 2	62415-4499	72415-4499	82415-4499	92415-4499	92418-4499
Brünnner CZ	Prisma 16,0 mm	62415-4461	72415-4461	82415-4461	92415-4461	92418-4461
	Prisma 19,5 mm	62415-4462	72415-4462	82415-4462	92415-4462	92418-4462
Chapuis	Express	62415-4429	72415-4429	82415-4429	92415-4429	92418-4429
Fair / Rizzini	Express	62415-4491	72415-4491	82415-4491	92415-4491	92418-4491
FN Browning	A-Bolt	62415-4420	72415-4420	82415-4420	92415-4420	92418-4420
	A-Bolt III	62415-442T	72415-442T	82415-442T	92415-442T	92418-442T
	A-Bolt WSSM	62415-441G	72415-441G	82415-441G	92415-441G	92418-441G
	BAR / BLR / CBL / Acera	62415-4403	72415-4403	82415-4403	92415-4403	92418-4403
	Eurobolt	62415-4478	72415-4478	82415-4478	92415-4478	92418-4478
	European	62415-4456	72415-4456	82415-4456	92415-4456	92418-4456
	Maral	62415-442J	72415-442J	82415-442J	92415-442J	92418-442J
	X-Bolt	62415-441P	72415-441P	82415-441P	92415-441P	92418-441P
Haenel	Jäger 10 (bis Serien-Nr. JX-000920)	62415-441W	72415-441W	82415-441W	92415-441W	92418-441W
	Jäger 10 (ab Serien-Nr. JX-000921)	62415-442C	72415-442C	82415-442C	92415-442C	92418-442C
	SLB 2000+	62415-442I	72415-442I	82415-442I	92415-442I	92418-442I
H&K	SLB 2000	62415-4408	72415-4408	82415-4408	92415-4408	92418-4408
Heym	SR 20	62415-4460	72415-4460	82415-4460	92415-4460	92418-4460
	SR 21	62415-4422	72415-4422	82415-4422	92415-4422	92418-4422
	SR 30	62415-4490	72415-4490	82415-4490	92415-4490	92418-4490
Howa	1500	62415-4459	72415-4459	82415-4459	92415-4459	92418-4459
Krico	600 / 700 / 900 / 902 Deluxe	62415-4406	72415-4406	82415-4406	92415-4406	92418-4406
Krieghoff	Semprio	62415-441C	72415-441C	82415-441C	92415-441C	92418-441C
Mauser	66	62415-4409	72415-4409	82415-4409	92415-4409	92418-4409
	M 94	62415-4494	72415-4494	82415-4494	92415-4494	92418-4494
	M 96	62415-4496	72415-4496	82415-4496	92415-4496	92418-4496
	M 96 (ab Serien-Nr. 12000) / M 97	62415-4497	72415-4497	82415-4497	92415-4497	92418-4497
	K 98 (und Nachbauten)	62415-4410	72415-4410	82415-4410	92415-4410	92418-4410
	M 12	62415-442L	72415-442L	82415-442L	92415-442L	92418-442L
Merkel	SR1	62415-4498	72415-4498	82415-4498	92415-4498	92418-4498
	SR1 Basic	62415-442D	72415-442D	82415-442D	92415-442D	92418-442D
Remington	700 (Gewinde UNS 6-48)	62415-4412	72415-4412	82415-4412	92415-4412	92418-4412
	700 (Gewinde UNS 8-40)	62415-441N	72415-441N	82415-441N	92415-441N	92418-441N
	783	62415-4425	72415-4425	82415-4425	92415-4425	92418-4425
	7400 / 7600 / 750	62415-4413	72415-4413	82415-4413	92415-4413	92418-4413
	Seven	62415-4419	72415-4419	82415-4419	92415-4419	92418-4419
RWS-Rößler	Titan 3 / Titan 6 / Titan α	62415-4492	72415-4492	82415-4492	92415-4492	92418-4492
	Titan 16	62415-442G	72415-442G	82415-442G	92415-442G	92418-442G
Sabatti	Express	62415-441K	72415-441K	82415-441K	92415-441K	92418-441K
Sako	konisches Prisma / tapered dovetail	62415-4453	72415-4453	82415-4453	92415-4453	92418-4453
Sauer	80 / 90 / 92	62415-4415	72415-4415	82415-4415	92415-4415	92418-4415
	101	62415-442K	72415-442K	82415-442K	92415-442K	92418-442K
	200	62415-4416	72415-4416	82415-4416	92415-4416	92418-4416
	202	62415-4480	72415-4480	82415-4480	92415-4480	92418-4480
Savage	ebene Hülsenbrücke / flat Top	62415-4435	72415-4435	82415-4435	92415-4435	92418-4435
	gerundete Hülsenbrücke / rounded Top	62415-4493	72415-4493	82415-4493	92415-4493	92418-4493
Steyr-Mannlicher	Luxus (siehe Katalog auf Seite 61)					
	SBS-96	62415-4487	72415-4487	82415-4487	92415-4487	92418-4487
	SBS-96 Export/Pro Hunter/Classic/SM12/CLII	62415-4488	72415-4488	82415-4488	92415-4488	92418-4488
Swiss Arms	SHR-970 (Bohrungsabstand 21,9 mm)	62415-4440	72415-4440	82415-4440	92415-4440	92418-4440
Tikka	T3	62415-4481	72415-4481	82415-4481	92415-4481	92418-4481
Verney-Carron	Impact NT / Plus	62415-4447	72415-4447	82415-4447	92415-4447	92418-4447
Voere	LBW	62415-4455	72415-4455	82415-4455	92415-4455	92418-4455
Weatherby	Mark V / 300 / Vanguard	62415-4423	72415-4423	82415-4423	92415-4423	92418-4423
Winchester	70 short / long action	62415-4424	72415-4424	82415-4424	92415-4424	92418-4424
	70 Magnum (Baujahr nach 1964)	62415-4425	72415-4425	82415-4425	92415-4425	92418-4425
	70 WSM	62415-4411	72415-4411	82415-4411	92415-4411	92418-4411
	70 WSSM	62415-4469	72415-4469	82415-4469	92415-4469	92418-4469
	SXR Vulcan	62415-441J	72415-441J	82415-441J	92415-441J	92418-441J
Zastava	70	62415-4401	72415-4401	82415-4401	92415-4401	92418-4401

Swing mounts with aluminum rings $\varnothing 1''/26$ mm / Montages pivotants avec colliers alu. $\varnothing 1''/26$ mm

- $\varnothing 1''/26$ mm
- Verlängerung 56 mm
- Bauhöhe: 18,5 mm
- Klemmringe aus Aluminium
- Ringbreite 15 mm

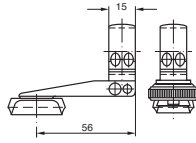
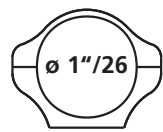

wahlweise mit folgenden ERAMATIC-Verschlüssen lieferbar:

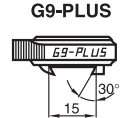
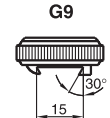
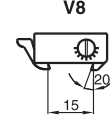
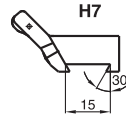
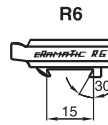

Anschütz	1780 / 1781	62415-562B	72415-562B	82415-562B	92415-562B	92418-562B
Antonio Zoli	1900	62415-5689	72415-5689	82415-5689	92415-5689	92418-5689
Benelli	ARGO	62415-5676	72415-5676	82415-5676	92415-5676	92418-5676
Beretta	689 gold sable / silver sable 2	62415-5699	72415-5699	82415-5699	92415-5699	92418-5699
Brünnner CZ	Prisma 16,0 mm	62415-5661	72415-5661	82415-5661	92415-5661	92418-5661
	Prisma 19,5 mm	62415-5662	72415-5662	82415-5662	92415-5662	92418-5662
Chapuis	Express	62415-5629	72415-5629	82415-5629	92415-5629	92418-5629
Fair / Rizzini	Express	62415-5691	72415-5691	82415-5691	92415-5691	92418-5691
FN Browning	A-Bolt	62415-5620	72415-5620	82415-5620	92415-5620	92418-5620
	A-Bolt III	62415-562T	72415-562T	82415-562T	92415-562T	92418-562T
	A-Bolt WSSM	62415-561G	72415-561G	82415-561G	92415-561G	92418-561G
	BAR / BLR / CBL / Acera	62415-5603	72415-5603	82415-5603	92415-5603	92418-5603
	Eurobolt	62415-5678	72415-5678	82415-5678	92415-5678	92418-5678
	European	62415-5656	72415-5656	82415-5656	92415-5656	92418-5656
	Maral	62415-562J	72415-562J	82415-562J	92415-562J	92418-562J
	X-Bolt	62415-561P	72415-561P	82415-561P	92415-561P	92418-561P
Haenel	Jäger 10 (bis Serien-Nr. JX-000920)	62415-561W	72415-561W	82415-561W	92415-561W	92418-561W
	Jäger 10 (ab Serien-Nr. JX-000921)	62415-562C	72415-562C	82415-562C	92415-562C	92418-562C
	SLB 2000+	62415-562I	72415-562I	82415-562I	92415-562I	92418-562I
H&K	SLB 2000	62415-5608	72415-5608	82415-5608	92415-5608	92418-5608
Heym	SR 20	62415-5660	72415-5660	82415-5660	92415-5660	92418-5660
	SR 21	62415-5622	72415-5622	82415-5622	92415-5622	92418-5622
	SR 30	62415-5690	72415-5690	82415-5690	92415-5690	92418-5690
Howa	1500	62415-5659	72415-5659	82415-5659	92415-5659	92418-5659
Krico	600 / 700 / 900 / 902 Deluxe	62415-5606	72415-5606	82415-5606	92415-5606	92418-5606
Krieghoff	Semprio	62415-561C	72415-561C	82415-561C	92415-561C	92418-561C
Mauser	66	62415-5609	72415-5609	82415-5609	92415-5609	92418-5609
	M 94	62415-5694	72415-5694	82415-5694	92415-5694	92418-5694
	M 96	62415-5696	72415-5696	82415-5696	92415-5696	92418-5696
	M 96 (ab Serien-Nr. 12000) / M 97	62415-5697	72415-5697	82415-5697	92415-5697	92418-5697
	K 98 (und Nachbauten)	62415-5610	72415-5610	82415-5610	92415-5610	92418-5610
	M 12	62415-562L	72415-562L	82415-562L	92415-562L	92418-562L
Merkel	SR1	62415-5698	72415-5698	82415-5698	92415-5698	92418-5698
	SR1 Basic	62415-562D	72415-562D	82415-562D	92415-562D	92418-562D
Remington	700 (Gewinde UNS 6-48)	62415-5612	72415-5612	82415-5612	92415-5612	92418-5612
	700 (Gewinde UNS 8-40)	62415-561N	72415-561N	82415-561N	92415-561N	92418-561N
	783	62415-5625	72415-5625	82415-5625	92415-5625	92418-5625
	7400 / 7600 / 750	62415-5613	72415-5613	82415-5613	92415-5613	92418-5613
	Seven	62415-5619	72415-5619	82415-5619	92415-5619	92418-5619
RWS-Rößler	Titan 3 / Titan 6 / Titan α	62415-5692	72415-5692	82415-5692	92415-5692	92418-5692
	Titan 16	62415-562G	72415-562G	82415-562G	92415-562G	92418-562G
Sabatti	Express	62415-561K	72415-561K	82415-561K	92415-561K	92418-561K
Sako	konisches Prisma / tapered dovetail	62415-5653	72415-5653	82415-5653	92415-5653	92418-5653
Sauer	80 / 90 / 92	62415-5615	72415-5615	82415-5615	92415-5615	92418-5615
	101	62415-562K	72415-562K	82415-562K	92415-562K	92418-562K
	200	62415-5616	72415-5616	82415-5616	92415-5616	92418-5616
	202	62415-5680	72415-5680	82415-5680	92415-5680	92418-5680
Savage	ebene Hülsenbrücke / flat Top	62415-5635	72415-5635	82415-5635	92415-5635	92418-5635
	gerundete Hülsenbrücke / rounded Top	62415-5693	72415-5693	82415-5693	92415-5693	92418-5693
Steyr-Mannlicher	Luxus (siehe Katalog auf Seite 61)					
	SBS-96	62415-5687	72415-5687	82415-5687	92415-5687	92418-5687
	SBS-96 Export/Pro Hunter/Classic/SM12/CLII	62415-5688	72415-5688	82415-5688	92415-5688	92418-5688
Swiss Arms	SHR-970 (Bohrungsabstand 21,9 mm)	62415-5640	72415-5640	82415-5640	92415-5640	92418-5640
Tikka	T3	62415-5681	72415-5681	82415-5681	92415-5681	92418-5681
Verney-Carron	Impact NT / Plus	62415-5647	72415-5647	82415-5647	92415-5647	92418-5647
Voere	LBW	62415-5655	72415-5655	82415-5655	92415-5655	92418-5655
Weatherby	Mark V / 300 / Vanguard	62415-5623	72415-5623	82415-5623	92415-5623	92418-5623
Winchester	70 short / long action	62415-5624	72415-5624	82415-5624	92415-5624	92418-5624
	70 Magnum (Baujahr nach 1964)	62415-5625	72415-5625	82415-5625	92415-5625	92418-5625
	70 WSM	62415-5611	72415-5611	82415-5611	92415-5611	92418-5611
	70 WSSM	62415-5669	72415-5669	82415-5669	92415-5669	92418-5669
	SXR Vulcan	62415-561J	72415-561J	82415-561J	92415-561J	92418-561J
Zastava	70	62415-5601	72415-5601	82415-5601	92415-5601	92418-5601

ERAMATIC®-SCHWENKMONTAGEN mit Stahl-Klemmringsen ø 30 mm

ERAMATIC®-Swing mounts with steel rings ø 30 mm

Ausführungen / Models:

- **Mögliche Verlängerungen:** ohne bzw. mit 26 mm, 31 mm, 44 mm und 56 mm
Available extensions: none (short), 26 mm, 31 mm, 44 mm and 56 mm
- **Bauhöhe / Height:** 18,5 mm
- **Ringbreite / Ring width:** 15,0 mm

Eramatic® Verschlussvarianten: Eramatic® lock-up systems:

- R6:** Verschlusskörper mit automatischer Verriegelungstechnik.
Für Prismenbasen und Schienenplatten mit 30°-Prisma.
Rotary locking system with automatic locking mechanism.
Fits all 30° rear dovetail bases and 30° rails.
- H7:** Verschlusskörper mit Entriegelungssicherung mittels Sperrklinke.
Für Prismenbasen und Schienenplatten mit 30°-Prisma.
Locking system with lever and integrated safety catch.
Fits all 30° rear dovetail bases and 30° rails.
- V8:** Verschlusskörper mit Doppelstangenverschluss.
Für Prismenbasen und Schienenplatten mit 20°-Prisma.
Locking system with self-locking clamp.
Fits all 20° rear bases and 20° rails.
- G9:** Verschlusskörper mit integriertem Kurvenspannsystem.
Für Prismenbasen und Schienenplatten mit 30°-Prisma und 15 mm Breite
sowie für 30° Laufschiene mit 12 mm und 14 mm Prismenbreite.
Rotary locking system.
Fits all 30° rear bases and 30° rails with a width of 12 mm, 14 mm or 15 mm.
- G9-Plus:** Verschlusskörper mit integriertem Kurvenspannsystem und geriffeltem Daumennocken.
Für Prismenbasen und Schienenplatten mit 30°-Prisma und 15 mm Breite.
Rotary locking system, specially shaped for easy handling.
Fits all 30° rear bases and 30° rails with a width of 15 mm.

Swing mounts with steel rings ø 30 mm / Montages pivotants avec colliers ø 30 mm

- ø 30 mm
- kurze Ausführung
- Bauhöhe: 18,5 mm
- Klemmringe aus Stahl
- Ringbreite 15 mm

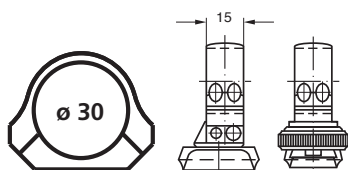

wahlweise mit folgenden ERAMATIC-Verschlüssen lieferbar:

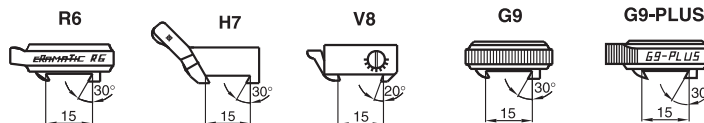

Anschütz	1780 / 1781	63015-002B	73015-002B	83015-002B	93015-002B	93018-002B
Antonio Zoli	1900	63015-0089	73015-0089	83015-0089	93015-0089	93018-0089
Benelli	ARGO	63015-0076	73015-0076	83015-0076	93015-0076	93018-0076
Beretta	689 gold sable / silver sable 2	63015-0099	73015-0099	83015-0099	93015-0099	93018-0099
Brünnner CZ	Prisma 16,0 mm	63015-0061	73015-0061	83015-0061	93015-0061	93018-0061
	Prisma 19,5 mm	63015-0062	73015-0062	83015-0062	93015-0062	93018-0062
Chapuis	Express	63015-0029	73015-0029	83015-0029	93015-0029	93018-0029
Fair / Rizzini	Express	63015-0091	73015-0091	83015-0091	93015-0091	93018-0091
FN Browning	A-Bolt	63015-0020	73015-0020	83015-0020	93015-0020	93018-0020
	A-Bolt III	63015-002T	73015-002T	83015-002T	93015-002T	93018-002T
	A-Bolt WSSM	63015-001G	73015-001G	83015-001G	93015-001G	93018-001G
	BAR / BLR / CBL / Acera	63015-0003	73015-0003	83015-0003	93015-0003	93018-0003
	Eurobolt	63015-0078	73015-0078	83015-0078	93015-0078	93018-0078
	European	63015-0056	73015-0056	83015-0056	93015-0056	93018-0056
	Maral	63015-002J	73015-002J	83015-002J	93015-002J	93018-002J
	X-Bolt	63015-001P	73015-001P	83015-001P	93015-001P	93018-001P
Haenel	Jäger 10 (bis Serien-Nr. JX-000920)	63015-001W	73015-001W	83015-001W	93015-001W	93018-001W
	Jäger 10 (ab Serien-Nr. JX-000921)	63015-002C	73015-002C	83015-002C	93015-002C	93018-002C
	SLB 2000+	63015-002I	73015-002I	83015-002I	93015-002I	93018-002I
H&K	SLB 2000	63015-0008	73015-0008	83015-0008	93015-0008	93018-0008
Heym	SR 20	63015-0060	73015-0060	83015-0060	93015-0060	93018-0060
	SR 21	63015-0022	73015-0022	83015-0022	93015-0022	93018-0022
	SR 30	63015-0090	73015-0090	83015-0090	93015-0090	93018-0090
Howa	1500	63015-0059	73015-0059	83015-0059	93015-0059	93018-0059
Krico	600 / 700 / 900 / 902 Deluxe	63015-0006	73015-0006	83015-0006	93015-0006	93018-0006
Krieghoff	Semprio	63015-001C	73015-001C	83015-001C	93015-001C	93018-001C
Mauser	66	63015-0009	73015-0009	83015-0009	93015-0009	93018-0009
	M 94	63015-0094	73015-0094	83015-0094	93015-0094	93018-0094
	M 96	63015-0096	73015-0096	83015-0096	93015-0096	93018-0096
	M 96 (ab Serien-Nr. 12000) / M 97	63015-0097	73015-0097	83015-0097	93015-0097	93018-0097
	K 98 (und Nachbauten)	63015-0010	73015-0010	83015-0010	93015-0010	93018-0010
	M 12	63015-002L	73015-002L	83015-002L	93015-002L	93018-002L
Merkel	SR1	63015-0098	73015-0098	83015-0098	93015-0098	93018-0098
	SR1 Basic	63015-002D	73015-002D	83015-002D	93015-002D	93018-002D
Remington	700 (Gewinde UNS 6-48)	63015-0012	73015-0012	83015-0012	93015-0012	93018-0012
	700 (Gewinde UNS 8-40)	63015-001N	73015-001N	83015-001N	93015-001N	93018-001N
	783	63015-0025	73015-0025	83015-0025	93015-0025	93018-0025
	7400 / 7600 / 750	63015-0013	73015-0013	83015-0013	93015-0013	93018-0013
	Seven	63015-0019	73015-0019	83015-0019	93015-0019	93018-0019
RWS-Rößler	Titan 3 / Titan 6 / Titan α	63015-0092	73015-0092	83015-0092	93015-0092	93018-0092
	Titan 16	63015-002G	73015-002G	83015-002G	93015-002G	93018-002G
Sabatti	Express	63015-001K	73015-001K	83015-001K	93015-001K	93018-001K
Sako	konisches Prisma / tapered dovetail	63015-0053	73015-0053	83015-0053	93015-0053	93018-0053
Sauer	80 / 90 / 92	63015-0015	73015-0015	83015-0015	93015-0015	93018-0015
	101	63015-002K	73015-002K	83015-002K	93015-002K	93018-002K
	200	63015-0016	73015-0016	83015-0016	93015-0016	93018-0016
	202	63015-0080	73015-0080	83015-0080	93015-0080	93018-0080
Savage	ebene Hülsenbrücke / flat Top	63015-0035	73015-0035	83015-0035	93015-0035	93018-0035
	gerundete Hülsenbrücke / rounded Top	63015-0093	73015-0093	83015-0093	93015-0093	93018-0093
Steyr-Mannlicher	Luxus (siehe Katalog auf Seite 61)					
	SBS-96	63015-0087	73015-0087	83015-0087	93015-0087	93018-0087
	SBS-96 Export/Pro Hunter/Classic/SM12/CLII	63015-0088	73015-0088	83015-0088	93015-0088	93018-0088
	Mannlicher-Schönauer GK	63015-0038	73015-0038		93015-0038	93018-0038
Swiss Arms	SHR-970 (Bohrungsabstand 21,9 mm)	63015-0040	73015-0040	83015-0040	93015-0040	93018-0040
Tikka	T3	63015-0081	73015-0081	83015-0081	93015-0081	93018-0081
Verney-Carron	Impact NT / Plus	63015-0047	73015-0047	83015-0047	93015-0047	93018-0047
Voere	LBW	63015-0055	73015-0055		93015-0055	93018-0055
Weatherby	Mark V / 300 / Vanguard	63015-0023	73015-0023	83015-0023	93015-0023	93018-0023
Winchester	70 short / long action	63015-0024	73015-0024	83015-0024	93015-0024	93018-0024
	70 Magnum (Baujahr nach 1964)	63015-0025	73015-0025	83015-0025	93015-0025	93018-0025
	70 WSM	63015-0011	73015-0011	83015-0011	93015-0011	93018-0011
	70 WSSM	63015-0069	73015-0069	83015-0069	93015-0069	93018-0069
	SXR Vulcan	63015-001J	73015-001J	83015-001J	93015-001J	93018-001J
Zastava	70	63015-0001	73015-0001	83015-0001	93015-0001	93018-0001

Swing mounts with steel rings \varnothing 30 mm / Montages pivotants avec colliers \varnothing 30 mm

- \varnothing 30 mm
- Verlängerung 26 mm
- Bauhöhe: 18,5 mm
- Klemmringse aus Stahl
- Ringbreite 15 mm

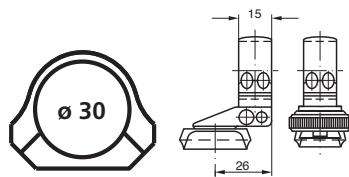

wahlweise mit folgenden ERAMATIC-Verschlüssen lieferbar:

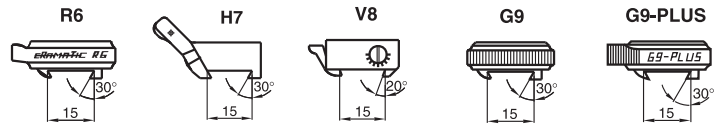

Anschütz	1780 / 1781	63015-262B	73015-262B	83015-262B	93015-262B	93018-262B
Antonio Zoli	1900	63015-2689	73015-2689	83015-2689	93015-2689	93018-2689
Benelli	ARGO	63015-2676	73015-2676	83015-2676	93015-2676	93018-2676
Beretta	689 gold sable / silver sable 2	63015-2699	73015-2699	83015-2699	93015-2699	93018-2699
Brünnner CZ	Prisma 16,0 mm	63015-2661	73015-2661	83015-2661	93015-2661	93018-2661
	Prisma 19,5 mm	63015-2662	73015-2662	83015-2662	93015-2662	93018-2662
Chapuis	Express	63015-2629	73015-2629	83015-2629	93015-2629	93018-2629
Fair / Rizzini	Express	63015-2691	73015-2691	83015-2691	93015-2691	93018-2691
FN Browning	A-Bolt	63015-2620	73015-2620	83015-2620	93015-2620	93018-2620
	A-Bolt III	63015-262T	73015-262T	83015-262T	93015-262T	93018-262T
	A-Bolt WSSM	63015-261G	73015-261G	83015-261G	93015-261G	93018-261G
	BAR / BLR / CBL / Acera	63015-2603	73015-2603	83015-2603	93015-2603	93018-2603
	Eurobolt	63015-2678	73015-2678	83015-2678	93015-2678	93018-2678
	European	63015-2656	73015-2656	83015-2656	93015-2656	93018-2656
	Maral	63015-262J	73015-262J	83015-262J	93015-262J	93018-262J
	X-Bolt	63015-261P	73015-261P	83015-261P	93015-261P	93018-261P
Haenel	Jäger 10 (bis Serien-Nr. JX-000920)	63015-261W	73015-261W	83015-261W	93015-261W	93018-261W
	Jäger 10 (ab Serien-Nr. JX-000921)	63015-262C	73015-262C	83015-262C	93015-262C	93018-262C
	SLB 2000+	63015-262I	73015-262I	83015-262I	93015-262I	93018-262I
H&K	SLB 2000	63015-2608	73015-2608	83015-2608	93015-2608	93018-2608
Heym	SR 20	63015-2660	73015-2660	83015-2660	93015-2660	93018-2660
	SR 21	63015-2622	73015-2622	83015-2622	93015-2622	93018-2622
	SR 30	63015-2690	73015-2690	83015-2690	93015-2690	93018-2690
Howa	1500	63015-2659	73015-2659	83015-2659	93015-2659	93018-2659
Krico	600 / 700 / 900 / 902 Deluxe	63015-2606	73015-2606	83015-2606	93015-2606	93018-2606
Krieghoff	Semprio	63015-261C	73015-261C	83015-261C	93015-261C	93018-261C
Mauser	66	63015-2609	73015-2609	83015-2609	93015-2609	93018-2609
	M 94	63015-2694	73015-2694	83015-2694	93015-2694	93018-2694
	M 96	63015-2696	73015-2696	83015-2696	93015-2696	93018-2696
	M 96 (ab Serien-Nr. 12000) / M 97	63015-2697	73015-2697	83015-2697	93015-2697	93018-2697
	K 98 (und Nachbauten)	63015-2610	73015-2610	83015-2610	93015-2610	93018-2610
	M 12	63015-262L	73015-262L	83015-262L	93015-262L	93018-262L
Merkel	SR1	63015-2698	73015-2698	83015-2698	93015-2698	93018-2698
	SR1 Basic	63015-262D	73015-262D	83015-262D	93015-262D	93018-262D
Remington	700 (Gewinde UNS 6-48)	63015-2612	73015-2612	83015-2612	93015-2612	93018-2612
	700 (Gewinde UNS 8-40)	63015-261N	73015-261N	83015-261N	93015-261N	93018-261N
	783	63015-2625	73015-2625	83015-2625	93015-2625	93018-2625
	7400 / 7600 / 750	63015-2613	73015-2613	83015-2613	93015-2613	93018-2613
	Seven	63015-2619	73015-2619	83015-2619	93015-2619	93018-2619
RWS-Rößler	Titan 3 / Titan 6 / Titan α	63015-2692	73015-2692	83015-2692	93015-2692	93018-2692
	Titan 16	63015-262G	73015-262G	83015-262G	93015-262G	93018-262G
Sabatti	Express	63015-261K	73015-261K	83015-261K	93015-261K	93018-261K
Sako	konisches Prisma / tapered dovetail	63015-2653	73015-2653	83015-2653	93015-2653	93018-2653
Sauer	80 / 90 / 92	63015-2615	73015-2615	83015-2615	93015-2615	93018-2615
	101	63015-262K	73015-262K	83015-262K	93015-262K	93018-262K
	200	63015-2616	73015-2616	83015-2616	93015-2616	93018-2616
	202	63015-2680	73015-2680	83015-2680	93015-2680	93018-2680
Savage	ebene Hülsenbrücke / flat Top	63015-2635	73015-2635	83015-2635	93015-2635	93018-2635
	gerundete Hülsenbrücke / rounded Top	63015-2693	73015-2693	83015-2693	93015-2693	93018-2693
Steyr-Mannlicher	Luxus (siehe Katalog auf Seite 61)					
	SBS-96	63015-2687	73015-2687	83015-2687	93015-2687	93018-2687
	SBS-96 Export/Pro Hunter/Classic/SM12/CLII	63015-2688	73015-2688	83015-2688	93015-2688	93018-2688
	Mannlicher-Schönauer GK	63015-2638	73015-2638		93015-2638	93018-2638
Swiss Arms	SHR-970 (Bohrungsabstand 21,9 mm)	63015-2640	73015-2640	83015-2640	93015-2640	93018-2640
Tikka	T3	63015-2681	73015-2681	83015-2681	93015-2681	93018-2681
Verney-Carron	Impact NT / Plus	63015-2647	73015-2647	83015-2647	93015-2647	93018-2647
Voerey	LBW	63015-2655	73015-2655		93015-2655	93018-2655
Weatherby	Mark V / 300 / Vanguard	63015-2623	73015-2623	83015-2623	93015-2623	93018-2623
Winchester	70 short / long action	63015-2624	73015-2624	83015-2624	93015-2624	93018-2624
	70 Magnum (Baujahr nach 1964)	63015-2625	73015-2625	83015-2625	93015-2625	93018-2625
	70 WSM	63015-2611	73015-2611	83015-2611	93015-2611	93018-2611
	70 WSSM	63015-2669	73015-2669	83015-2669	93015-2669	93018-2669
	SXR Vulcan	63015-261J	73015-261J	83015-261J	93015-261J	93018-261J
Zastava	70	63015-2601	73015-2601	83015-2601	93015-2601	93018-2601

Swing mounts with steel rings ø 30 mm / Montages pivotants avec colliers ø 30 mm

- ø 30 mm
- Verlängerung 31 mm
- Bauhöhe: 18,5 mm
- Klemmringe aus Stahl
- Ringbreite 15 mm

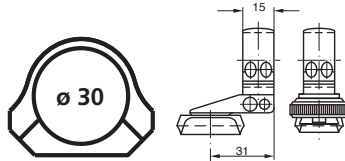

wahlweise mit folgenden ERAMATIC-Verschlüssen lieferbar:

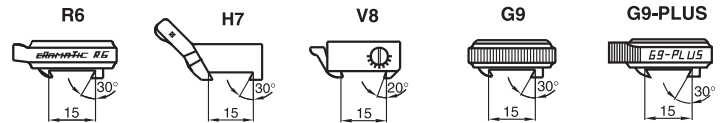

Anschütz	1780 / 1781	63015-312B	73015-312B	83015-312B	93015-312B	93018-312B
Antonio Zoli	1900	63015-3189	73015-3189	83015-3189	93015-3189	93018-3189
Benelli	ARGO	63015-3176	73015-3176	83015-3176	93015-3176	93018-3176
Beretta	689 gold sable / silver sable 2	63015-3199	73015-3199	83015-3199	93015-3199	93018-3199
Brünnner CZ	Prisma 16,0 mm	63015-3161	73015-3161	83015-3161	93015-3161	93018-3161
	Prisma 19,5 mm	63015-3162	73015-3162	83015-3162	93015-3162	93018-3162
Chapuis	Express	63015-3129	73015-3129	83015-3129	93015-3129	93018-3129
Fair / Rizzini	Express	63015-3191	73015-3191	83015-3191	93015-3191	93018-3191
FN Browning	A-Bolt	63015-3120	73015-3120	83015-3120	93015-3120	93018-3120
	A-Bolt III	63015-312T	73015-312T	83015-312T	93015-312T	93018-312T
	A-Bolt WSSM	63015-311G	73015-311G	83015-311G	93015-311G	93018-311G
	BAR / BLR / CBL / Acera	63015-3103	73015-3103	83015-3103	93015-3103	93018-3103
	Eurobolt	63015-3178	73015-3178	83015-3178	93015-3178	93018-3178
	European	63015-3156	73015-3156	83015-3156	93015-3156	93018-3156
	Maral	63015-312J	73015-312J	83015-312J	93015-312J	93018-312J
	X-Bolt	63015-311P	73015-311P	83015-311P	93015-311P	93018-311P
Haenel	Jäger 10 (bis Serien-Nr. JX-000920)	63015-311W	73015-311W	83015-311W	93015-311W	93018-311W
	Jäger 10 (ab Serien-Nr. JX-000921)	63015-312C	73015-312C	83015-312C	93015-312C	93018-312C
	SLB 2000+	63015-312I	73015-312I	83015-312I	93015-312I	93018-312I
H&K	SLB 2000	63015-3108	73015-3108	83015-3108	93015-3108	93018-3108
Heym	SR 20	63015-3160	73015-3160	83015-3160	93015-3160	93018-3160
	SR 21	63015-3122	73015-3122	83015-3122	93015-3122	93018-3122
	SR 30	63015-3190	73015-3190	83015-3190	93015-3190	93018-3190
Howa	1500	63015-3159	73015-3159	83015-3159	93015-3159	93018-3159
Krico	600 / 700 / 900 / 902 Deluxe	63015-3106	73015-3106	83015-3106	93015-3106	93018-3106
Krieghoff	Semprio	63015-311C	73015-311C	83015-311C	93015-311C	93018-311C
Mauser	66	63015-3109	73015-3109	83015-3109	93015-3109	93018-3109
	M 94	63015-3194	73015-3194	83015-3194	93015-3194	93018-3194
	M 96	63015-3196	73015-3196	83015-3196	93015-3196	93018-3196
	M 96 (ab Serien-Nr. 12000) / M 97	63015-3197	73015-3197	83015-3197	93015-3197	93018-3197
	K 98 (und Nachbauten)	63015-3110	73015-3110	83015-3110	93015-3110	93018-3110
	M 12	63015-312L	73015-312L	83015-312L	93015-312L	93018-312L
Merkel	SR1	63015-3198	73015-3198	83015-3198	93015-3198	93018-3198
	SR1 Basic	63015-312D	73015-312D	83015-312D	93015-312D	93018-312D
Remington	700 (Gewinde UNS 6-48)	63015-3112	73015-3112	83015-3112	93015-3112	93018-3112
	700 (Gewinde UNS 8-40)	63015-311N	73015-311N	83015-311N	93015-311N	93018-311N
	783	63015-3125	73015-3125	83015-3125	93015-3125	93018-3125
	7400 / 7600 / 750	63015-3113	73015-3113	83015-3113	93015-3113	93018-3113
	Seven	63015-3119	73015-3119	83015-3119	93015-3119	93018-3119
RWS-Rößler	Titan 3 / Titan 6 / Titan α	63015-3192	73015-3192	83015-3192	93015-3192	93018-3192
	Titan 16	63015-312G	73015-312G	83015-312G	93015-312G	93018-312G
Sabatti	Express	63015-311K	73015-311K	83015-311K	93015-311K	93018-311K
Sako	konisches Prisma / tapered dovetail	63015-3153	73015-3153	83015-3153	93015-3153	93018-3153
Sauer	80 / 90 / 92	63015-3115	73015-3115	83015-3115	93015-3115	93018-3115
	101	63015-312K	73015-312K	83015-312K	93015-312K	93018-312K
	200	63015-3116	73015-3116	83015-3116	93015-3116	93018-3116
	202	63015-3180	73015-3180	83015-3180	93015-3180	93018-3180
Savage	ebene Hülsenbrücke / flat Top	63015-3135	73015-3135	83015-3135	93015-3135	93018-3135
	gerundete Hülsenbrücke / rounded Top	63015-3193	73015-3193	83015-3193	93015-3193	93018-3193
Steyr-Mannlicher	Luxus (siehe Katalog auf Seite 61)					
	SBS-96	63015-3187	73015-3187	83015-3187	93015-3187	93018-3187
	SBS-96 Export/Pro Hunter/Classic/SM12/CLII	63015-3188	73015-3188	83015-3188	93015-3188	93018-3188
	Mannlicher-Schönauer GK	63015-3138	73015-3138		93015-3138	93018-3138
Swiss Arms	SHR-970 (Bohrungsabstand 21,9 mm)	63015-3140	73015-3140	83015-3140	93015-3140	93018-3140
Tikka	T3	63015-3181	73015-3181	83015-3181	93015-3181	93018-3181
Verney-Carron	Impact NT / Plus	63015-3147	73015-3147	83015-3147	93015-3147	93018-3147
Voere	LBW	63015-3155	73015-3155		93015-3155	93018-3155
Weatherby	Mark V / 300 / Vanguard	63015-3123	73015-3123	83015-3123	93015-3123	93018-3123
Winchester	70 short / long action	63015-3124	73015-3124	83015-3124	93015-3124	93018-3124
	70 Magnum (Baujahr nach 1964)	63015-3125	73015-3125	83015-3125	93015-3125	93018-3125
	70 WSM	63015-3111	73015-3111	83015-3111	93015-3111	93018-3111
	70 WSSM	63015-3169	73015-3169	83015-3169	93015-3169	93018-3169
	SXR Vulcan	63015-311J	73015-311J	83015-311J	93015-311J	93018-311J
Zastava	70	63015-3101	73015-3101	83015-3101	93015-3101	93018-3101

Swing mounts with steel rings \varnothing 30 mm / Montages pivotants avec colliers \varnothing 30 mm

- \varnothing 30 mm
- Verlängerung 44 mm
- Bauhöhe: 18,5 mm
- Klemmringse aus Stahl
- Ringbreite 15 mm

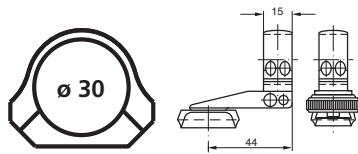

wahlweise mit folgenden ERAMATIC-Verschlüssen lieferbar:

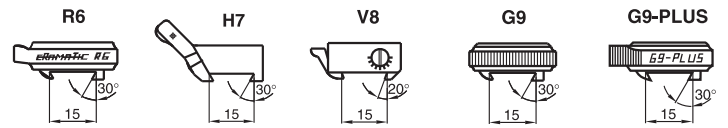

Anschütz	1780 / 1781	63015-442B	73015-442B	83015-442B	93015-442B	93018-442B
Antonio Zoli	1900	63015-4489	73015-4489	83015-4489	93015-4489	93018-4489
Benelli	ARGO	63015-4476	73015-4476	83015-4476	93015-4476	93018-4476
Beretta	689 gold sable / silver sable 2	63015-4499	73015-4499	83015-4499	93015-4499	93018-4499
Brünnner CZ	Prisma 16,0 mm	63015-4461	73015-4461	83015-4461	93015-4461	93018-4461
	Prisma 19,5 mm	63015-4462	73015-4462	83015-4462	93015-4462	93018-4462
Chapuis	Express	63015-4429	73015-4429	83015-4429	93015-4429	93018-4429
Fair / Rizzini	Express	63015-4491	73015-4491	83015-4491	93015-4491	93018-4491
FN Browning	A-Bolt	63015-4420	73015-4420	83015-4420	93015-4420	93018-4420
	A-Bolt III	63015-442T	73015-442T	83015-442T	93015-442T	93018-442T
	A-Bolt WSSM	63015-441G	73015-441G	83015-441G	93015-441G	93018-441G
	BAR / BLR / CBL / Acera	63015-4403	73015-4403	83015-4403	93015-4403	93018-4403
	Eurobolt	63015-4478	73015-4478	83015-4478	93015-4478	93018-4478
	European	63015-4456	73015-4456	83015-4456	93015-4456	93018-4456
	Maral	63015-442J	73015-442J	83015-442J	93015-442J	93018-442J
	X-Bolt	63015-441P	73015-441P	83015-441P	93015-441P	93018-441P
Haenel	Jäger 10 (bis Serien-Nr. JX-000920)	63015-441W	73015-441W	83015-441W	93015-441W	93018-441W
	Jäger 10 (ab Serien-Nr. JX-000921)	63015-442C	73015-442C	83015-442C	93015-442C	93018-442C
	SLB 2000+	63015-442I	73015-442I	83015-442I	93015-442I	93018-442I
H&K	SLB 2000	63015-4408	73015-4408	83015-4408	93015-4408	93018-4408
Heym	SR 20	63015-4460	73015-4460	83015-4460	93015-4460	93018-4460
	SR 21	63015-4422	73015-4422	83015-4422	93015-4422	93018-4422
	SR 30	63015-4490	73015-4490	83015-4490	93015-4490	93018-4490
Howa	1500	63015-4459	73015-4459	83015-4459	93015-4459	93018-4459
Krico	600 / 700 / 900 / 902 Deluxe	63015-4406	73015-4406	83015-4406	93015-4406	93018-4406
Krieghoff	Semprio	63015-441C	73015-441C	83015-441C	93015-441C	93018-441C
Mauser	66	63015-4409	73015-4409	83015-4409	93015-4409	93018-4409
	M 94	63015-4494	73015-4494	83015-4494	93015-4494	93018-4494
	M 96	63015-4496	73015-4496	83015-4496	93015-4496	93018-4496
	M 96 (ab Serien-Nr. 12000) / M 97	63015-4497	73015-4497	83015-4497	93015-4497	93018-4497
	K 98 (und Nachbauten)	63015-4410	73015-4410	83015-4410	93015-4410	93018-4410
	M 12	63015-442L	73015-442L	83015-442L	93015-442L	93018-442L
Merkel	SR1	63015-4498	73015-4498	83015-4498	93015-4498	93018-4498
	SR1 Basic	63015-442D	73015-442D	83015-442D	93015-442D	93018-442D
Remington	700 (Gewinde UNS 6-48)	63015-4412	73015-4412	83015-4412	93015-4412	93018-4412
	700 (Gewinde UNS 8-40)	63015-441N	73015-441N	83015-441N	93015-441N	93018-441N
	783	63015-4425	73015-4425	83015-4425	93015-4425	93018-4425
	7400 / 7600 / 750	63015-4413	73015-4413	83015-4413	93015-4413	93018-4413
	Seven	63015-4419	73015-4419	83015-4419	93015-4419	93018-4419
RWS-Rößler	Titan 3 / Titan 6 / Titan α	63015-4492	73015-4492	83015-4492	93015-4492	93018-4492
	Titan 16	63015-442G	73015-442G	83015-442G	93015-442G	93018-442G
Sabatti	Express	63015-441K	73015-441K	83015-441K	93015-441K	93018-441K
Sako	konisches Prisma / tapered dovetail	63015-4453	73015-4453	83015-4453	93015-4453	93018-4453
Sauer	80 / 90 / 92	63015-4415	73015-4415	83015-4415	93015-4415	93018-4415
	101	63015-442K	73015-442K	83015-442K	93015-442K	93018-442K
	200	63015-4416	73015-4416	83015-4416	93015-4416	93018-4416
	202	63015-4480	73015-4480	83015-4480	93015-4480	93018-4480
Savage	ebene Hülsenbrücke / flat Top	63015-4435	73015-4435	83015-4435	93015-4435	93018-4435
	gerundete Hülsenbrücke / rounded Top	63015-4493	73015-4493	83015-4493	93015-4493	93018-4493
Steyr-Mannlicher	Luxus (siehe Katalog auf Seite 61)					
	SBS-96	63015-4487	73015-4487	83015-4487	93015-4487	93018-4487
	SBS-96 Export/Pro Hunter/Classic/SM12/CLII	63015-4488	73015-4488	83015-4488	93015-4488	93018-4488
	Mannlicher-Schönauer GK	63015-4438	73015-4438		93015-4438	93018-4438
Swiss Arms	SHR-970 (Bohrungsabstand 21,9 mm)	63015-4440	73015-4440	83015-4440	93015-4440	93018-4440
Tikka	T3	63015-4481	73015-4481	83015-4481	93015-4481	93018-4481
Verney-Carron	Impact NT / Plus	63015-4447	73015-4447	83015-4447	93015-4447	93018-4447
Voere	LBW	63015-4455	73015-4455		93015-4455	93018-4455
Weatherby	Mark V / 300 / Vanguard	63015-4423	73015-4423	83015-4423	93015-4423	93018-4423
Winchester	70 short / long action	63015-4424	73015-4424	83015-4424	93015-4424	93018-4424
	70 Magnum (Baujahr nach 1964)	63015-4425	73015-4425	83015-4425	93015-4425	93018-4425
	70 WSM	63015-4411	73015-4411	83015-4411	93015-4411	93018-4411
	70 WSSM	63015-4469	73015-4469	83015-4469	93015-4469	93018-4469
	SXR Vulcan	63015-441J	73015-441J	83015-441J	93015-441J	93018-441J
Zastava	70	63015-4401	73015-4401	83015-4401	93015-4401	93018-4401

Swing mounts with steel rings ø 30 mm / Montages pivotants avec colliers ø 30 mm

- ø 30 mm
- Verlängerung 56 mm
- Bauhöhe: 18,5 mm
- Klemmringe aus Stahl
- Ringbreite 15 mm

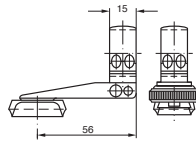

wahlweise mit folgenden ERAMATIC-Verschlüssen lieferbar:

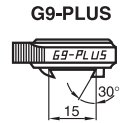
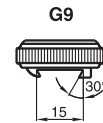
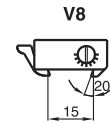
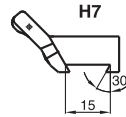
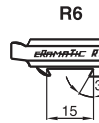

Anschütz	1780 / 1781	63015-562B	73015-562B	83015-562B	93015-562B	93018-562B
Antonio Zoli	1900	63015-5689	73015-5689	83015-5689	93015-5689	93018-5689
Benelli	ARGO	63015-5676	73015-5676	83015-5676	93015-5676	93018-5676
Beretta	689 gold sable / silver sable 2	63015-5699	73015-5699	83015-5699	93015-5699	93018-5699
Brünnner CZ	Prisma 16,0 mm	63015-5661	73015-5661	83015-5661	93015-5661	93018-5661
	Prisma 19,5 mm	63015-5662	73015-5662	83015-5662	93015-5662	93018-5662
Chapuis	Express	63015-5629	73015-5629	83015-5629	93015-5629	93018-5629
Fair / Rizzini	Express	63015-5691	73015-5691	83015-5691	93015-5691	93018-5691
FN Browning	A-Bolt	63015-5620	73015-5620	83015-5620	93015-5620	93018-5620
	A-Bolt III	63015-562T	73015-562T	83015-562T	93015-562T	93018-562T
	A-Bolt WSSM	63015-561G	73015-561G	83015-561G	93015-561G	93018-561G
	BAR / BLR / CBL / Acera	63015-5603	73015-5603	83015-5603	93015-5603	93018-5603
	Eurobolt	63015-5678	73015-5678	83015-5678	93015-5678	93018-5678
	European	63015-5656	73015-5656	83015-5656	93015-5656	93018-5656
	Maral	63015-562J	73015-562J	83015-562J	93015-562J	93018-562J
	X-Bolt	63015-561P	73015-561P	83015-561P	93015-561P	93018-561P
Haenel	Jäger 10 (bis Serien-Nr. JX-000920)	63015-561W	73015-561W	83015-561W	93015-561W	93018-561W
	Jäger 10 (ab Serien-Nr. JX-000921)	63015-562C	73015-562C	83015-562C	93015-562C	93018-562C
	SLB 2000+	63015-562I	73015-562I	83015-562I	93015-562I	93018-562I
H&K	SLB 2000	63015-5608	73015-5608	83015-5608	93015-5608	93018-5608
Heym	SR 20	63015-5660	73015-5660	83015-5660	93015-5660	93018-5660
	SR 21	63015-5622	73015-5622	83015-5622	93015-5622	93018-5622
	SR 30	63015-5690	73015-5690	83015-5690	93015-5690	93018-5690
Howa	1500	63015-5659	73015-5659	83015-5659	93015-5659	93018-5659
Krico	600 / 700 / 900 / 902 Deluxe	63015-5606	73015-5606	83015-5606	93015-5606	93018-5606
Krieghoff	Semprio	63015-561C	73015-561C	83015-561C	93015-561C	93018-561C
Mauser	66	63015-5609	73015-5609	83015-5609	93015-5609	93018-5609
	M 94	63015-5694	73015-5694	83015-5694	93015-5694	93018-5694
	M 96	63015-5696	73015-5696	83015-5696	93015-5696	93018-5696
	M 96 (ab Serien-Nr. 12000) / M 97	63015-5697	73015-5697	83015-5697	93015-5697	93018-5697
	K 98 (und Nachbauten)	63015-5610	73015-5610	83015-5610	93015-5610	93018-5610
	M 12	63015-562L	73015-562L	83015-562L	93015-562L	93018-562L
Merkel	SR1	63015-5698	73015-5698	83015-5698	93015-5698	93018-5698
	SR1 Basic	63015-562D	73015-562D	83015-562D	93015-562D	93018-562D
Remington	700 (Gewinde UNS 6-48)	63015-5612	73015-5612	83015-5612	93015-5612	93018-5612
	700 (Gewinde UNS 8-40)	63015-561N	73015-561N	83015-561N	93015-561N	93018-561N
	783	63015-5625	73015-5625	83015-5625	93015-5625	93018-5625
	7400 / 7600 / 750	63015-5613	73015-5613	83015-5613	93015-5613	93018-5613
	Seven	63015-5619	73015-5619	83015-5619	93015-5619	93018-5619
RWS-Rößler	Titan 3 / Titan 6 / Titan α	63015-5692	73015-5692	83015-5692	93015-5692	93018-5692
	Titan 16	63015-562G	73015-562G	83015-562G	93015-562G	93018-562G
Sabatti	Express	63015-561K	73015-561K	83015-561K	93015-561K	93018-561K
Sako	konisches Prisma / tapered dovetail	63015-5653	73015-5653	83015-5653	93015-5653	93018-5653
Sauer	80 / 90 / 92	63015-5615	73015-5615	83015-5615	93015-5615	93018-5615
	101	63015-562K	73015-562K	83015-562K	93015-562K	93018-562K
	200	63015-5616	73015-5616	83015-5616	93015-5616	93018-5616
	202	63015-5680	73015-5680	83015-5680	93015-5680	93018-5680
Savage	ebene Hülsenbrücke / flat Top	63015-5635	73015-5635	83015-5635	93015-5635	93018-5635
	gerundete Hülsenbrücke / rounded Top	63015-5693	73015-5693	83015-5693	93015-5693	93018-5693
Steyr-Mannlicher	Luxus (siehe Katalog auf Seite 61)					
	SBS-96	63015-5687	73015-5687	83015-5687	93015-5687	93018-5687
	SBS-96 Export/Pro Hunter/Classic/SM12/CLII	63015-5688	73015-5688	83015-5688	93015-5688	93018-5688
	Mannlicher-Schönauer GK	63015-5638	73015-5638		93015-5638	93018-5638
Swiss Arms	SHR-970 (Bohrungsabstand 21,9 mm)	63015-5640	73015-5640	83015-5640	93015-5640	93018-5640
Tikka	T3	63015-5681	73015-5681	83015-5681	93015-5681	93018-5681
Verney-Carron	Impact NT / Plus	63015-5647	73015-5647	83015-5647	93015-5647	93018-5647
Voere	LBW	63015-5655	73015-5655		93015-5655	93018-5655
Weatherby	Mark V / 300 / Vanguard	63015-5623	73015-5623	83015-5623	93015-5623	93018-5623
Winchester	70 short / long action	63015-5624	73015-5624	83015-5624	93015-5624	93018-5624
	70 Magnum (Baujahr nach 1964)	63015-5625	73015-5625	83015-5625	93015-5625	93018-5625
	70 WSM	63015-5611	73015-5611	83015-5611	93015-5611	93018-5611
	70 WSSM	63015-5669	73015-5669	83015-5669	93015-5669	93018-5669
	SXR Vulcan	63015-561J	73015-561J	83015-561J	93015-561J	93018-561J
Zastava	70	63015-5601	73015-5601	83015-5601	93015-5601	93018-5601

ERAMATIC®-SCHWENKMONTAGEN mit GK-Stahl-Klemmring ø 30 mm ERAMATIC®-Swing mounts with steel rings ø 30 mm

Ausführungen / Models:

- **Mögliche Verlängerungen:** ohne bzw. mit 38 mm und 56 mm
Available extensions: none (short), 38 mm and 56 mm
- **Bauhöhe / Height:** 18,5 mm
- **Ringbreiten:** vorderer Magnum-Ring 22 mm, hinterer Ring 15 mm
Ring width: front Magnum ring 22 mm, rear ring 15 mm

Eramatic® Verschlussvarianten: Eramatic® lock-up systems:

- R6:** Verschlusskörper mit automatischer Verriegelungstechnik.
Für Prismenbasen und Schienenplatten mit 30°-Prisma.
Rotary locking system with automatic locking mechanism.
Fits all 30° rear dovetail bases and 30° rails.
- H7:** Verschlusskörper mit Entriegelungssicherung mittels Sperrklinke.
Für Prismenbasen und Schienenplatten mit 30°-Prisma.
Locking system with lever and integrated safety catch.
Fits all 30° rear dovetail bases and 30° rails.
- V8:** Verschlusskörper mit Doppelstangenverschluss.
Für Prismenbasen und Schienenplatten mit 20°-Prisma.
Locking system with self-locking clamp.
Fits all 20° rear bases and 20° rails.
- G9:** Verschlusskörper mit integriertem Kurvenspannsystem.
Für Prismenbasen und Schienenplatten mit 30°-Prisma und 15 mm Breite
sowie für 30° Laufschiene mit 12 mm und 14 mm Prismenbreite.
Rotary locking system.
Fits all 30° rear bases and 30° rails with a width of 12 mm, 14 mm or 15 mm.
- G9-Plus:** Verschlusskörper mit integriertem Kurvenspannsystem und geriffeltem Daumennocken.
Für Prismenbasen und Schienenplatten mit 30°-Prisma und 15 mm Breite.
Rotary locking system, specially shaped for easy handling.
Fits all 30° rear bases and 30° rails with a width of 15 mm.

Swing mounts with 22 mm large steel rings ø 30 mm / Montages pivotants avec colliers ø 30 mm, largeur 22 mm

- ø 30 mm
- kurze Ausführung
- Bauhöhe: 18,5 mm
- Klemmringse aus Stahl
- GK-Vorderring 22 mm breit

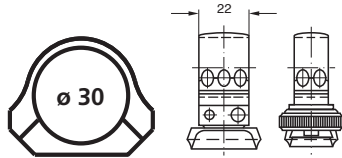

wahlweise mit folgenden ERAMATIC-Verschlüssen lieferbar:

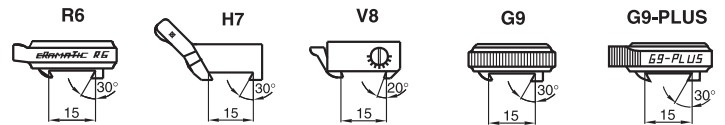

Anschütz	1780 / 1781	63022-002B	73022-002B	83022-002B	93022-002B	93028-002B
Antonio Zoli	1900	63022-0089	73022-0089	83022-0089	93022-0089	93028-0089
Benelli	ARGO	63022-0076	73022-0076	83022-0076	93022-0076	93028-0076
Beretta	689 gold sable / silver sable 2	63022-0099	73022-0099	83022-0099	93022-0099	93028-0099
Brüner CZ	Prisma 16,0 mm	63022-0061	73022-0061	83022-0061	93022-0061	93028-0061
	Prisma 19,5 mm	63022-0062	73022-0062	83022-0062	93022-0062	93028-0062
Chapuis	Express	63022-0029	73022-0029	83022-0029	93022-0029	93028-0029
Fair / Rizzini	Express	63022-0091	73022-0091	83022-0091	93022-0091	93028-0091
FN Browning	A-Bolt	63022-0020	73022-0020	83022-0020	93022-0020	93028-0020
	A-Bolt III	63022-002T	73022-002T	83022-002T	93022-002T	93028-002T
	A-Bolt WSSM	63022-001G	73022-001G	83022-001G	93022-001G	93028-001G
	BAR / BLR / CBL / Acera	63022-0003	73022-0003	83022-0003	93022-0003	93028-0003
	Eurobolt	63022-0078	73022-0078	83022-0078	93022-0078	93028-0078
	European	63022-0056	73022-0056	83022-0056	93022-0056	93028-0056
	Maral	63022-002J	73022-002J	83022-002J	93022-002J	93028-002J
	X-Bolt	63022-001P	73022-001P	83022-001P	93022-001P	93028-001P
Haenel	Jäger 10 (bis Serien-Nr. JX-000920)	63022-001W	73022-001W	83022-001W	93022-001W	93028-001W
	Jäger 10 (ab Serien-Nr. JX-000921)	63022-002C	73022-002C	83022-002C	93022-002C	93028-002C
	SLB 2000+	63022-002I	73022-002I	83022-002I	93022-002I	93028-002I
H&K	SLB 2000	63022-0008	73022-0008	83022-0008	93022-0008	93028-0008
Heym	SR 20	63022-0060	73022-0060	83022-0060	93022-0060	93028-0060
	SR 21	63022-0022	73022-0022	83022-0022	93022-0022	93028-0022
	SR 30	63022-0090	73022-0090	83022-0090	93022-0090	93028-0090
Howa	1500	63022-0059	73022-0059	83022-0059	93022-0059	93028-0059
Krico	600 / 700 / 900 / 902 Deluxe	63022-0006	73022-0006	83022-0006	93022-0006	93028-0006
Krieghoff	Semprio	63022-001C	73022-001C	83022-001C	93022-001C	93028-001C
Mauser	66	63022-0009	73022-0009	83022-0009	93022-0009	93028-0009
	M 94	63022-0094	73022-0094	83022-0094	93022-0094	93028-0094
	M 96	63022-0096	73022-0096	83022-0096	93022-0096	93028-0096
	M 96 (ab Serien-Nr. 12000) / M 97	63022-0097	73022-0097	83022-0097	93022-0097	93028-0097
	K 98 (und Nachbauten)	63022-0010	73022-0010	83022-0010	93022-0010	93028-0010
	M 12	63022-002L	73022-002L	83022-002L	93022-002L	93028-002L
Merkel	SR1	63022-0098	73022-0098	83022-0098	93022-0098	93028-0098
	SR1 Basic	63022-002D	73022-002D	83022-002D	93022-002D	93028-002D
Remington	700 (Gewinde UNS 6-48)	63022-0012	73022-0012	83022-0012	93022-0012	93028-0012
	700 (Gewinde UNS 8-40)	63022-001N	73022-001N	83022-001N	93022-001N	93028-001N
	783	63022-0025	73022-0025	83022-0025	93022-0025	93028-0025
	7400 / 7600 / 750	63022-0013	73022-0013	83022-0013	93022-0013	93028-0013
	Seven	63022-0019	73022-0019	83022-0019	93022-0019	93028-0019
RWS-Rößler	Titan 3 / Titan 6 / Titan α	63022-0092	73022-0092	83022-0092	93022-0092	93028-0092
	Titan 16	63022-002G	73022-002G	83022-002G	93022-002G	93028-002G
Sabatti	Express	63022-001K	73022-001K	83022-001K	93022-001K	93028-001K
Sako	konisches Prisma / tapered dovetail	63022-0053	73022-0053	83022-0053	93022-0053	93028-0053
Sauer	80 / 90 / 92	63022-0015	73022-0015	83022-0015	93022-0015	93028-0015
	101	63022-002K	73022-002K	83022-002K	93022-002K	93028-002K
	200	63022-0016	73022-0016	83022-0016	93022-0016	93028-0016
	202	63022-0080	73022-0080	83022-0080	93022-0080	93028-0080
Savage	ebene Hülsenbrücke / flat Top	63022-0035	73022-0035	83022-0035	93022-0035	93028-0035
	gerundete Hülsenbrücke / rounded Top	63022-0093	73022-0093	83022-0093	93022-0093	93028-0093
Steyr-Mannlicher	Luxus (siehe Katalog auf Seite 61)					
	SBS-96	63022-0087	73022-0087	83022-0087	93022-0087	93028-0087
	SBS-96 Export/Pro Hunter/Classic/SM12/CLII	63022-0088	73022-0088	83022-0088	93022-0088	93028-0088
	Mannlicher-Schönauer GK	63022-0038	73022-0038		93022-0038	93028-0038
Swiss Arms	SHR-970 (Bohrungsabstand 21,9 mm)	63022-0040	73022-0040	83022-0040	93022-0040	93028-0040
Tikka	T3	63022-0081	73022-0081	83022-0081	93022-0081	93028-0081
Verney-Carron	Impact NT / Plus	63022-0047	73022-0047	83022-0047	93022-0047	93028-0047
Voere	LBW	63022-0055	73022-0055		93022-0055	93028-0055
Weatherby	Mark V / 300 / Vanguard	63022-0023	73022-0023	83022-0023	93022-0023	93028-0023
Winchester	70 short / long action	63022-0024	73022-0024	83022-0024	93022-0024	93028-0024
	70 Magnum (Baujahr nach 1964)	63022-0025	73022-0025	83022-0025	93022-0025	93028-0025
	70 WSM	63022-0011	73022-0011	83022-0011	93022-0011	93028-0011
	70 WSSM	63022-0069	73022-0069	83022-0069	93022-0069	93028-0069
	SXR Vulcan	63022-001J	73022-001J	83022-001J	93022-001J	93028-001J
Zastava	70	63022-0001	73022-0001	83022-0001	93022-0001	93028-0001

Swing mounts with 22 mm large steel rings ø 30 mm / Montages pivotants avec colliers ø 30 mm, largeur 22 mm

- ø 30 mm
- Verlängerung 38 mm
- Bauhöhe: 18,5 mm
- Klemmringe aus Stahl
- GK-Vorderring 22 mm breit

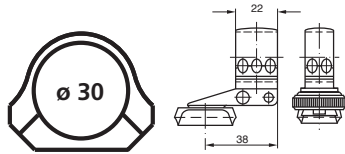

wahlweise mit folgenden ERAMATIC-Verschlüssen lieferbar:

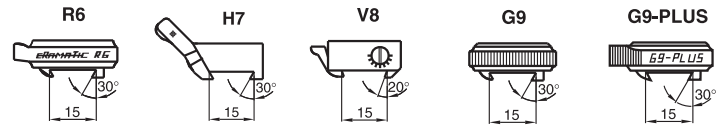

Anschütz	1780 / 1781	63022-382B	73022-382B	83022-382B	93022-382B	93028-382B
Antonio Zoli	1900	63022-3889	73022-3889	83022-3889	93022-3889	93028-3889
Benelli	ARGO	63022-3876	73022-3876	83022-3876	93022-3876	93028-3876
Beretta	689 gold sable / silver sable 2	63022-3899	73022-3899	83022-3899	93022-3899	93028-3899
Brünnner CZ	Prisma 16,0 mm	63022-3861	73022-3861	83022-3861	93022-3861	93028-3861
	Prisma 19,5 mm	63022-3862	73022-3862	83022-3862	93022-3862	93028-3862
Chapuis	Express	63022-3829	73022-3829	83022-3829	93022-3829	93028-3829
Fair / Rizzini	Express	63022-3891	73022-3891	83022-3891	93022-3891	93028-3891
FN Browning	A-Bolt	63022-3820	73022-3820	83022-3820	93022-3820	93028-3820
	A-Bolt III	63022-382T	73022-382T	83022-382T	93022-382T	93028-382T
	A-Bolt WSSM	63022-381G	73022-381G	83022-381G	93022-381G	93028-381G
	BAR / BLR / CBL / Acera	63022-3803	73022-3803	83022-3803	93022-3803	93028-3803
	Eurobolt	63022-3878	73022-3878	83022-3878	93022-3878	93028-3878
	European	63022-3856	73022-3856	83022-3856	93022-3856	93028-3856
	Maral	63022-382J	73022-382J	83022-382J	93022-382J	93028-382J
	X-Bolt	63022-381P	73022-381P	83022-381P	93022-381P	93028-381P
Haenel	Jäger 10 (bis Serien-Nr. JX-000920)	63022-381W	73022-381W	83022-381W	93022-381W	93028-381W
	Jäger 10 (ab Serien-Nr. JX-000921)	63022-382C	73022-382C	83022-382C	93022-382C	93028-382C
	SLB 2000+	63022-382I	73022-382I	83022-382I	93022-382I	93028-382I
H&K	SLB 2000	63022-3808	73022-3808	83022-3808	93022-3808	93028-3808
Heym	SR 20	63022-3860	73022-3860	83022-3860	93022-3860	93028-3860
	SR 21	63022-3822	73022-3822	83022-3822	93022-3822	93028-3822
	SR 30	63022-3890	73022-3890	83022-3890	93022-3890	93028-3890
Howa	1500	63022-3859	73022-3859	83022-3859	93022-3859	93028-3859
Krico	600 / 700 / 900 / 902 Deluxe	63022-3806	73022-3806	83022-3806	93022-3806	93028-3806
Krieghoff	Semprio	63022-381C	73022-381C	83022-381C	93022-381C	93028-381C
Mauser	66	63022-3809	73022-3809	83022-3809	93022-3809	93028-3809
	M 94	63022-3894	73022-3894	83022-3894	93022-3894	93028-3894
	M 96	63022-3896	73022-3896	83022-3896	93022-3896	93028-3896
	M 96 (ab Serien-Nr. 12000) / M 97	63022-3897	73022-3897	83022-3897	93022-3897	93028-3897
	K 98 (und Nachbauten)	63022-3810	73022-3810	83022-3810	93022-3810	93028-3810
	M 12	63022-382L	73022-382L	83022-382L	93022-382L	93028-382L
Merkel	SR1	63022-3898	73022-3898	83022-3898	93022-3898	93028-3898
	SR1 Basic	63022-382D	73022-382D	83022-382D	93022-382D	93028-382D
Remington	700 (Gewinde UNS 6-48)	63022-3812	73022-3812	83022-3812	93022-3812	93028-3812
	700 (Gewinde UNS 8-40)	63022-381N	73022-381N	83022-381N	93022-381N	93028-381N
	783	63022-3825	73022-3825	83022-3825	93022-3825	93028-3825
	7400 / 7600 / 750	63022-3813	73022-3813	83022-3813	93022-3813	93028-3813
	Seven	63022-3819	73022-3819	83022-3819	93022-3819	93028-3819
RWS-Rößler	Titan 3 / Titan 6 / Titan α	63022-3892	73022-3892	83022-3892	93022-3892	93028-3892
	Titan 16	63022-382G	73022-382G	83022-382G	93022-382G	93028-382G
Sabatti	Express	63022-381K	73022-381K	83022-381K	93022-381K	93028-381K
Sako	konisches Prisma / tapered dovetail	63022-3853	73022-3853	83022-3853	93022-3853	93028-3853
Sauer	80 / 90 / 92	63022-3815	73022-3815	83022-3815	93022-3815	93028-3815
	101	63022-382K	73022-382K	83022-382K	93022-382K	93028-382K
	200	63022-3816	73022-3816	83022-3816	93022-3816	93028-3816
	202	63022-3880	73022-3880	83022-3880	93022-3880	93028-3880
Savage	ebene Hülsenbrücke / flat Top	63022-3835	73022-3835	83022-3835	93022-3835	93028-3835
	gerundete Hülsenbrücke / rounded Top	63022-3893	73022-3893	83022-3893	93022-3893	93028-3893
Steyr-Mannlicher	Luxus (siehe Katalog auf Seite 61)					
	SBS-96	63022-3887	73022-3887	83022-3887	93022-3887	93028-3887
	SBS-96 Export/Pro Hunter/Classic/SM12/CLII	63022-3888	73022-3888	83022-3888	93022-3888	93028-3888
	Mannlicher-Schönauer GK	63022-3838	73022-3838		93022-3838	93028-3838
Swiss Arms	SHR-970 (Bohrungsabstand 21,9 mm)	63022-3840	73022-3840	83022-3840	93022-3840	93028-3840
Tikka	T3	63022-3881	73022-3881	83022-3881	93022-3881	93028-3881
Verney-Carron	Impact NT / Plus	63022-3847	73022-3847	83022-3847	93022-3847	93028-3847
Voere	LBW	63022-3855	73022-3855		93022-3855	93028-3855
Weatherby	Mark V / 300 / Vanguard	63022-3823	73022-3823	83022-3823	93022-3823	93028-3823
Winchester	70 short / long action	63022-3824	73022-3824	83022-3824	93022-3824	93028-3824
	70 Magnum (Baujahr nach 1964)	63022-3825	73022-3825	83022-3825	93022-3825	93028-3825
	70 WSM	63022-3811	73022-3811	83022-3811	93022-3811	93028-3811
	70 WSSM	63022-3869	73022-3869	83022-3869	93022-3869	93028-3869
	SXR Vulcan	63022-381J	73022-381J	83022-381J	93022-381J	93028-381J
Zastava	70	63022-3801	73022-3801	83022-3801	93022-3801	93028-3801

Swing mounts with 22 mm large steel rings ø 30 mm / Montages pivotants avec colliers ø 30 mm, largeur 22 mm

- ø 30 mm
- Verlängerung 56 mm
- Bauhöhe: 18,5 mm
- Klemmringse aus Stahl
- GK-Vorderring 22 mm breit

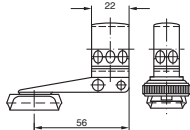

wahlweise mit folgenden ERAMATIC-Verschlüssen lieferbar:

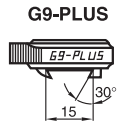
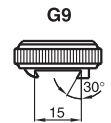
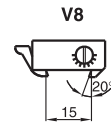
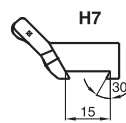
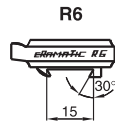

Anschütz	1780 / 1781	63022-562B	73022-562B	83022-562B	93022-562B	93028-562B
Antonio Zoli	1900	63022-5689	73022-5689	83022-5689	93022-5689	93028-5689
Benelli	ARGO	63022-5676	73022-5676	83022-5676	93022-5676	93028-5676
Beretta	689 gold sable / silver sable 2	63022-5699	73022-5699	83022-5699	93022-5699	93028-5699
Brünnner CZ	Prisma 16,0 mm	63022-5661	73022-5661	83022-5661	93022-5661	93028-5661
	Prisma 19,5 mm	63022-5662	73022-5662	83022-5662	93022-5662	93028-5662
Chapuis	Express	63022-5629	73022-5629	83022-5629	93022-5629	93028-5629
Fair / Rizzini	Express	63022-5691	73022-5691	83022-5691	93022-5691	93028-5691
FN Browning	A-Bolt	63022-5620	73022-5620	83022-5620	93022-5620	93028-5620
	A-Bolt III	63022-562T	73022-562T	83022-562T	93022-562T	93028-562T
	A-Bolt WSSM	63022-561G	73022-561G	83022-561G	93022-561G	93028-561G
	BAR / BLR / CBL / Acera	63022-5603	73022-5603	83022-5603	93022-5603	93028-5603
	Eurobolt	63022-5678	73022-5678	83022-5678	93022-5678	93028-5678
	European	63022-5656	73022-5656	83022-5656	93022-5656	93028-5656
	Maral	63022-562J	73022-562J	83022-562J	93022-562J	93028-562J
	X-Bolt	63022-561P	73022-561P	83022-561P	93022-561P	93028-561P
Haenel	Jäger 10 (bis Serien-Nr. JX-000920)	63022-561W	73022-561W	83022-561W	93022-561W	93028-561W
	Jäger 10 (ab Serien-Nr. JX-000921)	63022-562C	73022-562C	83022-562C	93022-562C	93028-562C
	SLB 2000+	63022-562I	73022-562I	83022-562I	93022-562I	93028-562I
H&K	SLB 2000	63022-5608	73022-5608	83022-5608	93022-5608	93028-5608
Heym	SR 20	63022-5660	73022-5660	83022-5660	93022-5660	93028-5660
	SR 21	63022-5622	73022-5622	83022-5622	93022-5622	93028-5622
	SR 30	63022-5690	73022-5690	83022-5690	93022-5690	93028-5690
Howa	1500	63022-5659	73022-5659	83022-5659	93022-5659	93028-5659
Krico	600 / 700 / 900 / 902 Deluxe	63022-5606	73022-5606	83022-5606	93022-5606	93028-5606
Krieghoff	Semprio	63022-561C	73022-561C	83022-561C	93022-561C	93028-561C
Mauser	66	63022-5609	73022-5609	83022-5609	93022-5609	93028-5609
	M 94	63022-5694	73022-5694	83022-5694	93022-5694	93028-5694
	M 96	63022-5696	73022-5696	83022-5696	93022-5696	93028-5696
	M 96 (ab Serien-Nr. 12000) / M 97	63022-5697	73022-5697	83022-5697	93022-5697	93028-5697
	K 98 (und Nachbauten)	63022-5610	73022-5610	83022-5610	93022-5610	93028-5610
	M 12	63022-562L	73022-562L	83022-562L	93022-562L	93028-562L
Merkel	SR1	63022-5698	73022-5698	83022-5698	93022-5698	93028-5698
	SR1 Basic	63022-562D	73022-562D	83022-562D	93022-562D	93028-562D
Remington	700 (Gewinde UNS 6-48)	63022-5612	73022-5612	83022-5612	93022-5612	93028-5612
	700 (Gewinde UNS 8-40)	63022-561N	73022-561N	83022-561N	93022-561N	93028-561N
	783	63022-5625	73022-5625	83022-5625	93022-5625	93028-5625
	7400 / 7600 / 750	63022-5613	73022-5613	83022-5613	93022-5613	93028-5613
	Seven	63022-5619	73022-5619	83022-5619	93022-5619	93028-5619
RWS-Röbller	Titan 3 / Titan 6 / Titan α	63022-5692	73022-5692	83022-5692	93022-5692	93028-5692
	Titan 16	63022-562G	73022-562G	83022-562G	93022-562G	93028-562G
Sabatti	Express	63022-561K	73022-561K	83022-561K	93022-561K	93028-561K
Sako	konisches Prisma / tapered dovetail	63022-5653	73022-5653	83022-5653	93022-5653	93028-5653
Sauer	80 / 90 / 92	63022-5615	73022-5615	83022-5615	93022-5615	93028-5615
	101	63022-562K	73022-562K	83022-562K	93022-562K	93028-562K
	200	63022-5616	73022-5616	83022-5616	93022-5616	93028-5616
	202	63022-5680	73022-5680	83022-5680	93022-5680	93028-5680
Savage	ebene Hülsenbrücke / flat Top	63022-5635	73022-5635	83022-5635	93022-5635	93028-5635
	gerundete Hülsenbrücke / rounded Top	63022-5693	73022-5693	83022-5693	93022-5693	93028-5693
Steyr-Mannlicher	Luxus (siehe Katalog auf Seite 61)					
	SBS-96	63022-5687	73022-5687	83022-5687	93022-5687	93028-5687
	SBS-96 Export/Pro Hunter/Classic/SM12/CLII	63022-5688	73022-5688	83022-5688	93022-5688	93028-5688
	Mannlicher-Schönauer GK	63022-5638	73022-5638		93022-5638	93028-5638
Swiss Arms	SHR-970 (Bohrungsabstand 21,9 mm)	63022-5640	73022-5640	83022-5640	93022-5640	93028-5640
Tikka	T3	63022-5681	73022-5681	83022-5681	93022-5681	93028-5681
Verney-Carron	Impact NT / Plus	63022-5647	73022-5647	83022-5647	93022-5647	93028-5647
Voere	LBW	63022-5655	73022-5655		93022-5655	93028-5655
Weatherby	Mark V / 300 / Vanguard	63022-5623	73022-5623	83022-5623	93022-5623	93028-5623
Winchester	70 short / long action	63022-5624	73022-5624	83022-5624	93022-5624	93028-5624
	70 Magnum (Baujahr nach 1964)	63022-5625	73022-5625	83022-5625	93022-5625	93028-5625
	70 WSM	63022-5611	73022-5611	83022-5611	93022-5611	93028-5611
	70 WSSM	63022-5669	73022-5669	83022-5669	93022-5669	93028-5669
	SXR Vulcan	63022-561J	73022-561J	83022-561J	93022-561J	93028-561J
Zastava	70	63022-5601	73022-5601	83022-5601	93022-5601	93028-5601

ERAMATIC®-SCHWENKMONTAGEN mit Light-Klemmringsen ø 30 mm

ERAMATIC®-Swing mounts with aluminium rings ø 30 mm

Ausführungen / Models:

- **Mögliche Verlängerungen:** ohne bzw. mit 26 mm, 31 mm, 44 mm und 56 mm
Available extensions: none (short), 26 mm, 31 mm, 44 mm and 56 mm
- **Bauhöhe / Height:** 18,5 mm
- **Ringbreite / Ring width:** 15,0 mm

Eramatic® Verschlussvarianten: Eramatic® lock-up systems:

- R6:** Verschlusskörper mit automatischer Verriegelungstechnik.
Für Prismenbasen und Schienenplatten mit 30°-Prisma.
Rotary locking system with automatic locking mechanism.
Fits all 30° rear dovetail bases and 30° rails.
- H7:** Verschlusskörper mit Entriegelungssicherung mittels Sperrklinke.
Für Prismenbasen und Schienenplatten mit 30°-Prisma.
Locking system with lever and integrated safety catch.
Fits all 30° rear dovetail bases and 30° rails.
- V8:** Verschlusskörper mit Doppelstangenverschluss.
Für Prismenbasen und Schienenplatten mit 20°-Prisma.
Locking system with self-locking clamp.
Fits all 20° rear bases and 20° rails.
- G9:** Verschlusskörper mit integriertem Kurvenspannsystem.
Für Prismenbasen und Schienenplatten mit 30°-Prisma und 15 mm Breite
sowie für 30° Laufschiene mit 12 mm und 14 mm Prismenbreite.
Rotary locking system.
Fits all 30° rear bases and 30° rails with a width of 12 mm, 14 mm or 15 mm.
- G9-Plus:** Verschlusskörper mit integriertem Kurvenspannsystem und geriffeltem Daumennocken.
Für Prismenbasen und Schienenplatten mit 30°-Prisma und 15 mm Breite.
Rotary locking system, specially shaped for easy handling.
Fits all 30° rear bases and 30° rails with a width of 15 mm.

Swing mounts with aluminum rings ø 30 mm / Montages pivotants avec colliers alu. ø 30 mm

- ø 30 mm
- kurze Ausführung
- Bauhöhe: 18,5 mm
- Klemmringse aus Aluminium
- Ringbreite 15 mm

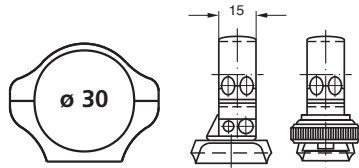

wahlweise mit folgenden ERAMATIC-Verschlüssen lieferbar:

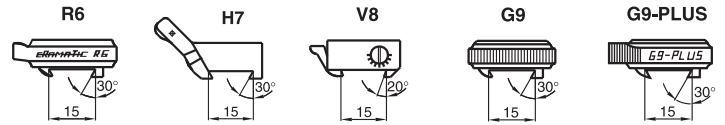

Anschütz	1780 / 1781	62815-002B	72815-002B	82815-002B	92815-002B	92818-002B
Antonio Zoli	1900	62815-0089	72815-0089	82815-0089	92815-0089	92818-0089
Benelli	ARGO	62815-0076	72815-0076	82815-0076	92815-0076	92818-0076
Beretta	689 gold sable / silver sable 2	62815-0099	72815-0099	82815-0099	92815-0099	92818-0099
Brüner CZ	Prisma 16,0 mm	62815-0061	72815-0061	82815-0061	92815-0061	92818-0061
	Prisma 19,5 mm	62815-0062	72815-0062	82815-0062	92815-0062	92818-0062
Chapuis	Express	62815-0029	72815-0029	82815-0029	92815-0029	92818-0029
Fair / Rizzini	Express	62815-0091	72815-0091	82815-0091	92815-0091	92818-0091
FN Browning	A-Bolt	62815-0020	72815-0020	82815-0020	92815-0020	92818-0020
	A-Bolt III	62815-002T	72815-002T	82815-002T	92815-002T	92818-002T
	A-Bolt WSSM	62815-001G	72815-001G	82815-001G	92815-001G	92818-001G
	BAR / BLR / CBL / Acera	62815-0003	72815-0003	82815-0003	92815-0003	92818-0003
	Eurobolt	62815-0078	72815-0078	82815-0078	92815-0078	92818-0078
	European	62815-0056	72815-0056	82815-0056	92815-0056	92818-0056
	Maral	62815-002J	72815-002J	82815-002J	92815-002J	92818-002J
	X-Bolt	62815-001P	72815-001P	82815-001P	92815-001P	92818-001P
Haenel	Jäger 10 (bis Serien-Nr. JX-000920)	62815-001W	72815-001W	82815-001W	92815-001W	92818-001W
	Jäger 10 (ab Serien-Nr. JX-000921)	62815-002C	72815-002C	82815-002C	92815-002C	92818-002C
	SLB 2000+	62815-002I	72815-002I	82815-002I	92815-002I	92818-002I
H&K	SLB 2000	62815-0008	72815-0008	82815-0008	92815-0008	92818-0008
Heym	SR 20	62815-0060	72815-0060	82815-0060	92815-0060	92818-0060
	SR 21	62815-0022	72815-0022	82815-0022	92815-0022	92818-0022
	SR 30	62815-0090	72815-0090	82815-0090	92815-0090	92818-0090
Howa	1500	62815-0059	72815-0059	82815-0059	92815-0059	92818-0059
Krico	600 / 700 / 900 / 902 Deluxe	62815-0006	72815-0006	82815-0006	92815-0006	92818-0006
Krieghoff	Semprio	62815-001C	72815-001C	82815-001C	92815-001C	92818-001C
Mauser	66	62815-0009	72815-0009	82815-0009	92815-0009	92818-0009
	M 94	62815-0094	72815-0094	82815-0094	92815-0094	92818-0094
	M 96	62815-0096	72815-0096	82815-0096	92815-0096	92818-0096
	M 96 (ab Serien-Nr. 12000) / M 97	62815-0097	72815-0097	82815-0097	92815-0097	92818-0097
	K 98 (und Nachbauten)	62815-0010	72815-0010	82815-0010	92815-0010	92818-0010
	M 12	62815-002L	72815-002L	82815-002L	92815-002L	92818-002L
Merkel	SR1	62815-0098	72815-0098	82815-0098	92815-0098	92818-0098
	SR1 Basic	62815-002D	72815-002D	82815-002D	92815-002D	92818-002D
Remington	700 (Gewinde UNS 6-48)	62815-0012	72815-0012	82815-0012	92815-0012	92818-0012
	700 (Gewinde UNS 8-40)	62815-001N	72815-001N	82815-001N	92815-001N	92818-001N
	783	62815-0025	72815-0025	82815-0025	92815-0025	92818-0025
	7400 / 7600 / 750	62815-0013	72815-0013	82815-0013	92815-0013	92818-0013
	Seven	62815-0019	72815-0019	82815-0019	92815-0019	92818-0019
RWS-Röbler	Titan 3 / Titan 6 / Titan α	62815-0092	72815-0092	82815-0092	92815-0092	92818-0092
	Titan 16	62815-002G	72815-002G	82815-002G	92815-002G	92818-002G
Sabatti	Express	62815-001K	72815-001K	82815-001K	92815-001K	92818-001K
Sako	konisches Prisma / tapered dovetail	62815-0053	72815-0053	82815-0053	92815-0053	92818-0053
Sauer	80 / 90 / 92	62815-0015	72815-0015	82815-0015	92815-0015	92818-0015
	101	62815-002K	72815-002K	82815-002K	92815-002K	92818-002K
	200	62815-0016	72815-0016	82815-0016	92815-0016	92818-0016
	202	62815-0080	72815-0080	82815-0080	92815-0080	92818-0080
Savage	ebene Hülsenbrücke / flat Top	62815-0035	72815-0035	82815-0035	92815-0035	92818-0035
	gerundete Hülsenbrücke / rounded Top	62815-0093	72815-0093	82815-0093	92815-0093	92818-0093
Steyr-Mannlicher	Luxus (siehe Katalog auf Seite 61)					
	SBS-96	62815-0087	72815-0087	82815-0087	92815-0087	92818-0087
	SBS-96 Export/Pro Hunter/Classic/SM12/CLII	62815-0088	72815-0088	82815-0088	92815-0088	92818-0088
Swiss Arms	SHR-970 (Bohrungsabstand 21,9 mm)	62815-0040	72815-0040	82815-0040	92815-0040	92818-0040
Tikka	T3	62815-0081	72815-0081	82815-0081	92815-0081	92818-0081
Verney-Carron	Impact NT / Plus	62815-0047	72815-0047	82815-0047	92815-0047	92818-0047
Voere	LBW	62815-0055	72815-0055	82815-0055	92815-0055	92818-0055
Weatherby	Mark V / 300 / Vanguard	62815-0023	72815-0023	82815-0023	92815-0023	92818-0023
Winchester	70 short / long action	62815-0024	72815-0024	82815-0024	92815-0024	92818-0024
	70 Magnum (Baujahr nach 1964)	62815-0025	72815-0025	82815-0025	92815-0025	92818-0025
	70 WSM	62815-0011	72815-0011	82815-0011	92815-0011	92818-0011
	70 WSSM	62815-0069	72815-0069	82815-0069	92815-0069	92818-0069
	SXR Vulcan	62815-001J	72815-001J	82815-001J	92815-001J	92818-001J
Zastava	70	62815-0001	72815-0001	82815-0001	92815-0001	92818-0001

Swing mounts with aluminum rings ø 30 mm / Montages pivotants avec colliers alu. ø 30 mm

- ø 30 mm
- Verlängerung 26 mm
- Bauhöhe: 18,5 mm
- Klemmringse aus Aluminium
- Ringbreite 15 mm

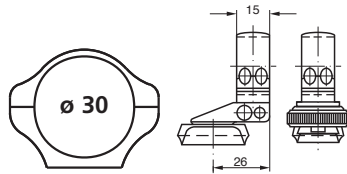

wahlweise mit folgenden ERAMATIC-Verschlüssen lieferbar:

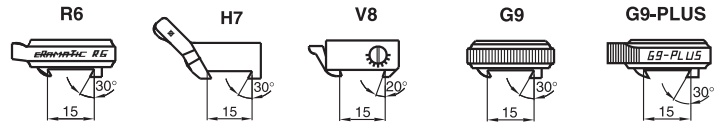

Anschütz	1780 / 1781	62815-262B	72815-262B	82815-262B	92815-262B	92818-262B
Antonio Zoli	1900	62815-2689	72815-2689	82815-2689	92815-2689	92818-2689
Benelli	ARGO	62815-2676	72815-2676	82815-2676	92815-2676	92818-2676
Beretta	689 gold sable / silver sable 2	62815-2699	72815-2699	82815-2699	92815-2699	92818-2699
Brünnner CZ	Prisma 16,0 mm	62815-2661	72815-2661	82815-2661	92815-2661	92818-2661
	Prisma 19,5 mm	62815-2662	72815-2662	82815-2662	92815-2662	92818-2662
Chapuis	Express	62815-2629	72815-2629	82815-2629	92815-2629	92818-2629
Fair / Rizzini	Express	62815-2691	72815-2691	82815-2691	92815-2691	92818-2691
FN Browning	A-Bolt	62815-2620	72815-2620	82815-2620	92815-2620	92818-2620
	A-Bolt III	62815-262T	72815-262T	82815-262T	92815-262T	92818-262T
	A-Bolt WSSM	62815-261G	72815-261G	82815-261G	92815-261G	92818-261G
	BAR / BLR / CBL / Acera	62815-2603	72815-2603	82815-2603	92815-2603	92818-2603
	Eurobolt	62815-2678	72815-2678	82815-2678	92815-2678	92818-2678
	European	62815-2656	72815-2656	82815-2656	92815-2656	92818-2656
	Maral	62815-262J	72815-262J	82815-262J	92815-262J	92818-262J
	X-Bolt	62815-261P	72815-261P	82815-261P	92815-261P	92818-261P
Haenel	Jäger 10 (bis Serien-Nr. JX-000920)	62815-261W	72815-261W	82815-261W	92815-261W	92818-261W
	Jäger 10 (ab Serien-Nr. JX-000921)	62815-262C	72815-262C	82815-262C	92815-262C	92818-262C
	SLB 2000+	62815-262I	72815-262I	82815-262I	92815-262I	92818-262I
H&K	SLB 2000	62815-2608	72815-2608	82815-2608	92815-2608	92818-2608
Heym	SR 20	62815-2660	72815-2660	82815-2660	92815-2660	92818-2660
	SR 21	62815-2622	72815-2622	82815-2622	92815-2622	92818-2622
	SR 30	62815-2690	72815-2690	82815-2690	92815-2690	92818-2690
Howa	1500	62815-2659	72815-2659	82815-2659	92815-2659	92818-2659
Krico	600 / 700 / 900 / 902 Deluxe	62815-2606	72815-2606	82815-2606	92815-2606	92818-2606
Krieghoff	Semprio	62815-261C	72815-261C	82815-261C	92815-261C	92818-261C
Mauser	66	62815-2609	72815-2609	82815-2609	92815-2609	92818-2609
	M 94	62815-2694	72815-2694	82815-2694	92815-2694	92818-2694
	M 96	62815-2696	72815-2696	82815-2696	92815-2696	92818-2696
	M 96 (ab Serien-Nr. 12000) / M 97	62815-2697	72815-2697	82815-2697	92815-2697	92818-2697
	K 98 (und Nachbauten)	62815-2610	72815-2610	82815-2610	92815-2610	92818-2610
	M 12	62815-262L	72815-262L	82815-262L	92815-262L	92818-262L
Merkel	SR1	62815-2698	72815-2698	82815-2698	92815-2698	92818-2698
	SR1 Basic	62815-262D	72815-262D	82815-262D	92815-262D	92818-262D
Remington	700 (Gewinde UNS 6-48)	62815-2612	72815-2612	82815-2612	92815-2612	92818-2612
	700 (Gewinde UNS 8-40)	62815-261N	72815-261N	82815-261N	92815-261N	92818-261N
	783	62815-2625	72815-2625	82815-2625	92815-2625	92818-2625
	7400 / 7600 / 750	62815-2613	72815-2613	82815-2613	92815-2613	92818-2613
	Seven	62815-2619	72815-2619	82815-2619	92815-2619	92818-2619
RWS-Rößler	Titan 3 / Titan 6 / Titan α	62815-2692	72815-2692	82815-2692	92815-2692	92818-2692
	Titan 16	62815-262G	72815-262G	82815-262G	92815-262G	92818-262G
Sabatti	Express	62815-261K	72815-261K	82815-261K	92815-261K	92818-261K
Sako	konisches Prisma / tapered dovetail	62815-2653	72815-2653	82815-2653	92815-2653	92818-2653
Sauer	80 / 90 / 92	62815-2615	72815-2615	82815-2615	92815-2615	92818-2615
	101	62815-262K	72815-262K	82815-262K	92815-262K	92818-262K
	200	62815-2616	72815-2616	82815-2616	92815-2616	92818-2616
	202	62815-2680	72815-2680	82815-2680	92815-2680	92818-2680
Savage	ebene Hülsenbrücke / flat Top	62815-2635	72815-2635	82815-2635	92815-2635	92818-2635
	gerundete Hülsenbrücke / rounded Top	62815-2693	72815-2693	82815-2693	92815-2693	92818-2693
Steyr-Mannlicher	Luxus (siehe Katalog auf Seite 61)					
	SBS-96	62815-2687	72815-2687	82815-2687	92815-2687	92818-2687
	SBS-96 Export/Pro Hunter/Classic/SM12/CLII	62815-2688	72815-2688	82815-2688	92815-2688	92818-2688
Swiss Arms	SHR-970 (Bohrungsabstand 21,9 mm)	62815-2640	72815-2640	82815-2640	92815-2640	92818-2640
Tikka	T3	62815-2681	72815-2681	82815-2681	92815-2681	92818-2681
Verney-Carron	Impact NT / Plus	62815-2647	72815-2647	82815-2647	92815-2647	92818-2647
Voere	LBW	62815-2655	72815-2655	82815-2655	92815-2655	92818-2655
Weatherby	Mark V / 300 / Vanguard	62815-2623	72815-2623	82815-2623	92815-2623	92818-2623
Winchester	70 short / long action	62815-2624	72815-2624	82815-2624	92815-2624	92818-2624
	70 Magnum (Baujahr nach 1964)	62815-2625	72815-2625	82815-2625	92815-2625	92818-2625
	70 WSM	62815-2611	72815-2611	82815-2611	92815-2611	92818-2611
	70 WSSM	62815-2669	72815-2669	82815-2669	92815-2669	92818-2669
	SXR Vulcan	62815-261J	72815-261J	82815-261J	92815-261J	92818-261J
Zastava	70	62815-2601	72815-2601	82815-2601	92815-2601	92818-2601

Swing mounts with aluminum rings ø 30 mm / Montages pivotants avec colliers alu. ø 30 mm

- ø 30 mm
- Verlängerung 31 mm
- Bauhöhe: 18,5 mm
- Klemmringe aus Aluminium
- Ringbreite 15 mm

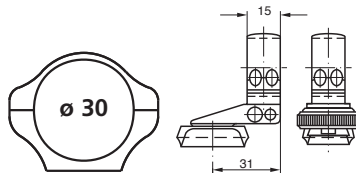

wahlweise mit folgenden ERAMATIC-Verschlüssen lieferbar:

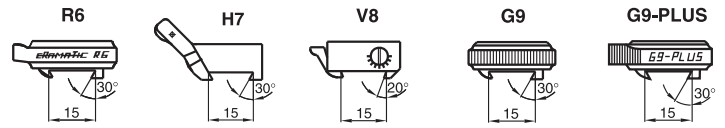

Anschütz	1780 / 1781	62815-312B	72815-312B	82815-312B	92815-312B	92818-312B
Antonio Zoli	1900	62815-3189	72815-3189	82815-3189	92815-3189	92818-3189
Benelli	ARGO	62815-3176	72815-3176	82815-3176	92815-3176	92818-3176
Beretta	689 gold sable / silver sable 2	62815-3199	72815-3199	82815-3199	92815-3199	92818-3199
Brünnner CZ	Prisma 16,0 mm	62815-3161	72815-3161	82815-3161	92815-3161	92818-3161
	Prisma 19,5 mm	62815-3162	72815-3162	82815-3162	92815-3162	92818-3162
Chapuis	Express	62815-3129	72815-3129	82815-3129	92815-3129	92818-3129
Fair / Rizzini	Express	62815-3191	72815-3191	82815-3191	92815-3191	92818-3191
FN Browning	A-Bolt	62815-3120	72815-3120	82815-3120	92815-3120	92818-3120
	A-Bolt III	62815-312T	72815-312T	82815-312T	92815-312T	92818-312T
	A-Bolt WSSM	62815-311G	72815-311G	82815-311G	92815-311G	92818-311G
	BAR / BLR / CBL / Acera	62815-3103	72815-3103	82815-3103	92815-3103	92818-3103
	Eurobolt	62815-3178	72815-3178	82815-3178	92815-3178	92818-3178
	European	62815-3156	72815-3156	82815-3156	92815-3156	92818-3156
	Maral	62815-312J	72815-312J	82815-312J	92815-312J	92818-312J
	X-Bolt	62815-311P	72815-311P	82815-311P	92815-311P	92818-311P
Haenel	Jäger 10 (bis Serien-Nr. JX-000920)	62815-311W	72815-311W	82815-311W	92815-311W	92818-311W
	Jäger 10 (ab Serien-Nr. JX-000921)	62815-312C	72815-312C	82815-312C	92815-312C	92818-312C
	SLB 2000+	62815-312I	72815-312I	82815-312I	92815-312I	92818-312I
H&K	SLB 2000	62815-3108	72815-3108	82815-3108	92815-3108	92818-3108
Heym	SR 20	62815-3160	72815-3160	82815-3160	92815-3160	92818-3160
	SR 21	62815-3122	72815-3122	82815-3122	92815-3122	92818-3122
	SR 30	62815-3190	72815-3190	82815-3190	92815-3190	92818-3190
Howa	1500	62815-3159	72815-3159	82815-3159	92815-3159	92818-3159
Krico	600 / 700 / 900 / 902 Deluxe	62815-3106	72815-3106	82815-3106	92815-3106	92818-3106
Krieghoff	Semprio	62815-311C	72815-311C	82815-311C	92815-311C	92818-311C
Mauser	66	62815-3109	72815-3109	82815-3109	92815-3109	92818-3109
	M 94	62815-3194	72815-3194	82815-3194	92815-3194	92818-3194
	M 96	62815-3196	72815-3196	82815-3196	92815-3196	92818-3196
	M 96 (ab Serien-Nr. 12000) / M 97	62815-3197	72815-3197	82815-3197	92815-3197	92818-3197
	K 98 (und Nachbauten)	62815-3110	72815-3110	82815-3110	92815-3110	92818-3110
	M 12	62815-312L	72815-312L	82815-312L	92815-312L	92818-312L
Merkel	SR1	62815-3198	72815-3198	82815-3198	92815-3198	92818-3198
	SR1 Basic	62815-312D	72815-312D	82815-312D	92815-312D	92818-312D
Remington	700 (Gewinde UNS 6-48)	62815-3112	72815-3112	82815-3112	92815-3112	92818-3112
	700 (Gewinde UNS 8-40)	62815-311N	72815-311N	82815-311N	92815-311N	92818-311N
	783	62815-3125	72815-3125	82815-3125	92815-3125	92818-3125
	7400 / 7600 / 750	62815-3113	72815-3113	82815-3113	92815-3113	92818-3113
	Seven	62815-3119	72815-3119	82815-3119	92815-3119	92818-3119
RWS-Rößler	Titan 3 / Titan 6 / Titan α	62815-3192	72815-3192	82815-3192	92815-3192	92818-3192
	Titan 16	62815-312G	72815-312G	82815-312G	92815-312G	92818-312G
Sabatti	Express	62815-311K	72815-311K	82815-311K	92815-311K	92818-311K
Sako	konisches Prisma / tapered dovetail	62815-3153	72815-3153	82815-3153	92815-3153	92818-3153
Sauer	80 / 90 / 92	62815-3115	72815-3115	82815-3115	92815-3115	92818-3115
	101	62815-312K	72815-312K	82815-312K	92815-312K	92818-312K
	200	62815-3116	72815-3116	82815-3116	92815-3116	92818-3116
	202	62815-3180	72815-3180	82815-3180	92815-3180	92818-3180
Savage	ebene Hülsenbrücke / flat Top	62815-3135	72815-3135	82815-3135	92815-3135	92818-3135
	gerundete Hülsenbrücke / rounded Top	62815-3193	72815-3193	82815-3193	92815-3193	92818-3193
Steyr-Mannlicher	Luxus (siehe Katalog auf Seite 61)					
	SBS-96	62815-3187	72815-3187	82815-3187	92815-3187	92818-3187
	SBS-96 Export/Pro Hunter/Classic/SM12/CLII	62815-3188	72815-3188	82815-3188	92815-3188	92818-3188
Swiss Arms	SHR-970 (Bohrungsabstand 21,9 mm)	62815-3140	72815-3140	82815-3140	92815-3140	92818-3140
Tikka	T3	62815-3181	72815-3181	82815-3181	92815-3181	92818-3181
Verney-Carron	Impact NT / Plus	62815-3147	72815-3147	82815-3147	92815-3147	92818-3147
Voere	LBW	62815-3155	72815-3155	82815-3155	92815-3155	92818-3155
Weatherby	Mark V / 300 / Vanguard	62815-3123	72815-3123	82815-3123	92815-3123	92818-3123
Winchester	70 short / long action	62815-3124	72815-3124	82815-3124	92815-3124	92818-3124
	70 Magnum (Baujahr nach 1964)	62815-3125	72815-3125	82815-3125	92815-3125	92818-3125
	70 WSM	62815-311I	72815-311I	82815-311I	92815-311I	92818-311I
	70 WSSM	62815-3169	72815-3169	82815-3169	92815-3169	92818-3169
	SXR Vulcan	62815-311J	72815-311J	82815-311J	92815-311J	92818-311J
Zastava	70	62815-3101	72815-3101	82815-3101	92815-3101	92818-3101

Swing mounts with aluminum rings ø 30 mm / Montages pivotants avec colliers alu. ø 30 mm

- ø 30 mm
- Verlängerung 44 mm
- Bauhöhe: 18,5 mm
- Klemmringe aus Aluminium
- Ringbreite 15 mm

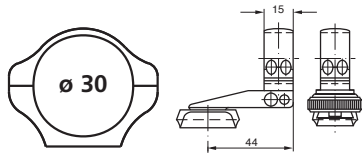

wahlweise mit folgenden ERAMATIC-Verschlüssen lieferbar:

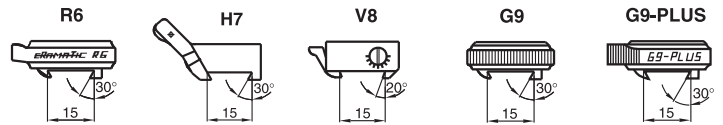

Anschütz	1780 / 1781	62815-442B	72815-442B	82815-442B	92815-442B	92818-442B
Antonio Zoli	1900	62815-4489	72815-4489	82815-4489	92815-4489	92818-4489
Benelli	ARGO	62815-4476	72815-4476	82815-4476	92815-4476	92818-4476
Beretta	689 gold sable / silver sable 2	62815-4499	72815-4499	82815-4499	92815-4499	92818-4499
Brügger CZ	Prisma 16,0 mm	62815-4461	72815-4461	82815-4461	92815-4461	92818-4461
	Prisma 19,5 mm	62815-4462	72815-4462	82815-4462	92815-4462	92818-4462
Chapuis	Express	62815-4429	72815-4429	82815-4429	92815-4429	92818-4429
Fair / Rizzini	Express	62815-4491	72815-4491	82815-4491	92815-4491	92818-4491
FN Browning	A-Bolt	62815-4420	72815-4420	82815-4420	92815-4420	92818-4420
	A-Bolt III	62815-442T	72815-442T	82815-442T	92815-442T	92818-442T
	A-Bolt WSSM	62815-441G	72815-441G	82815-441G	92815-441G	92818-441G
	BAR / BLR / CBL / Acera	62815-4403	72815-4403	82815-4403	92815-4403	92818-4403
	Eurobolt	62815-4478	72815-4478	82815-4478	92815-4478	92818-4478
	European	62815-4456	72815-4456	82815-4456	92815-4456	92818-4456
	Maral	62815-442J	72815-442J	82815-442J	92815-442J	92818-442J
	X-Bolt	62815-441P	72815-441P	82815-441P	92815-441P	92818-441P
Haenel	Jäger 10 (bis Serien-Nr. JX-000920)	62815-441W	72815-441W	82815-441W	92815-441W	92818-441W
	Jäger 10 (ab Serien-Nr. JX-000921)	62815-442C	72815-442C	82815-442C	92815-442C	92818-442C
	SLB 2000+	62815-442I	72815-442I	82815-442I	92815-442I	92818-442I
H&K	SLB 2000	62815-4408	72815-4408	82815-4408	92815-4408	92818-4408
Heym	SR 20	62815-4460	72815-4460	82815-4460	92815-4460	92818-4460
	SR 21	62815-4422	72815-4422	82815-4422	92815-4422	92818-4422
	SR 30	62815-4490	72815-4490	82815-4490	92815-4490	92818-4490
Howa	1500	62815-4459	72815-4459	82815-4459	92815-4459	92818-4459
Krico	600 / 700 / 900 / 902 Deluxe	62815-4406	72815-4406	82815-4406	92815-4406	92818-4406
Krieghoff	Semprio	62815-441C	72815-441C	82815-441C	92815-441C	92818-441C
Mauser	66	62815-4409	72815-4409	82815-4409	92815-4409	92818-4409
	M 94	62815-4494	72815-4494	82815-4494	92815-4494	92818-4494
	M 96	62815-4496	72815-4496	82815-4496	92815-4496	92818-4496
	M 96 (ab Serien-Nr. 12000) / M 97	62815-4497	72815-4497	82815-4497	92815-4497	92818-4497
	K 98 (und Nachbauten)	62815-4410	72815-4410	82815-4410	92815-4410	92818-4410
	M 12	62815-442L	72815-442L	82815-442L	92815-442L	92818-442L
Merkel	SR1	62815-4498	72815-4498	82815-4498	92815-4498	92818-4498
	SR1 Basic	62815-442D	72815-442D	82815-442D	92815-442D	92818-442D
Remington	700 (Gewinde UNS 6-48)	62815-4412	72815-4412	82815-4412	92815-4412	92818-4412
	700 (Gewinde UNS 8-40)	62815-441N	72815-441N	82815-441N	92815-441N	92818-441N
	783	62815-4425	72815-4425	82815-4425	92815-4425	92818-4425
	7400 / 7600 / 750	62815-4413	72815-4413	82815-4413	92815-4413	92818-4413
	Seven	62815-4419	72815-4419	82815-4419	92815-4419	92818-4419
RWS-Rößler	Titan 3 / Titan 6 / Titan α	62815-4492	72815-4492	82815-4492	92815-4492	92818-4492
	Titan 16	62815-442G	72815-442G	82815-442G	92815-442G	92818-442G
Sabatti	Express	62815-441K	72815-441K	82815-441K	92815-441K	92818-441K
Sako	konisches Prisma / tapered dovetail	62815-4453	72815-4453	82815-4453	92815-4453	92818-4453
Sauer	80 / 90 / 92	62815-4415	72815-4415	82815-4415	92815-4415	92818-4415
	101	62815-442K	72815-442K	82815-442K	92815-442K	92818-442K
	200	62815-4416	72815-4416	82815-4416	92815-4416	92818-4416
	202	62815-4480	72815-4480	82815-4480	92815-4480	92818-4480
Savage	ebene Hülsenbrücke / flat Top	62815-4435	72815-4435	82815-4435	92815-4435	92818-4435
	gerundete Hülsenbrücke / rounded Top	62815-4493	72815-4493	82815-4493	92815-4493	92818-4493
Steyr-Mannlicher	Luxus (siehe Katalog auf Seite 61)					
	SBS-96	62815-4487	72815-4487	82815-4487	92815-4487	92818-4487
	SBS-96 Export/Pro Hunter/Classic/SM12/CLII	62815-4488	72815-4488	82815-4488	92815-4488	92818-4488
Swiss Arms	SHR-970 (Bohrungsabstand 21,9 mm)	62815-4440	72815-4440	82815-4440	92815-4440	92818-4440
Tikka	T3	62815-4481	72815-4481	82815-4481	92815-4481	92818-4481
Verney-Carron	Impact NT / Plus	62815-4447	72815-4447	82815-4447	92815-4447	92818-4447
Voere	LBW	62815-4455	72815-4455	82815-4455	92815-4455	92818-4455
Weatherby	Mark V / 300 / Vanguard	62815-4423	72815-4423	82815-4423	92815-4423	92818-4423
Winchester	70 short / long action	62815-4424	72815-4424	82815-4424	92815-4424	92818-4424
	70 Magnum (Baujahr nach 1964)	62815-4425	72815-4425	82815-4425	92815-4425	92818-4425
	70 WSM	62815-4411	72815-4411	82815-4411	92815-4411	92818-4411
	70 WSSM	62815-4469	72815-4469	82815-4469	92815-4469	92818-4469
	SXR Vulcan	62815-441J	72815-441J	82815-441J	92815-441J	92818-441J
Zastava	70	62815-4401	72815-4401	82815-4401	92815-4401	92818-4401

Swing mounts with aluminum rings ø 30 mm / Montages pivotants avec colliers alu. ø 30 mm

- ø 30 mm
- Verlängerung 56 mm
- Bauhöhe: 18,5 mm
- Klemmringse aus Aluminium
- Ringbreite 15 mm

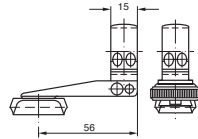
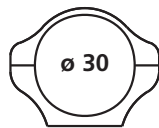

wahlweise mit folgenden ERAMATIC-Verschlüssen lieferbar:

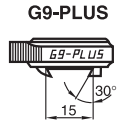
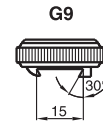
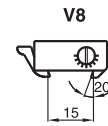
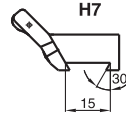
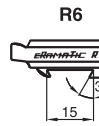

Anschütz	1780 / 1781	62815-562B	72815-562B	82815-562B	92815-562B	92818-562B
Antonio Zoli	1900	62815-5689	72815-5689	82815-5689	92815-5689	92818-5689
Benelli	ARGO	62815-5676	72815-5676	82815-5676	92815-5676	92818-5676
Beretta	689 gold sable / silver sable 2	62815-5699	72815-5699	82815-5699	92815-5699	92818-5699
Brünnner CZ	Prisma 16,0 mm	62815-5661	72815-5661	82815-5661	92815-5661	92818-5661
	Prisma 19,5 mm	62815-5662	72815-5662	82815-5662	92815-5662	92818-5662
Chapuis	Express	62815-5629	72815-5629	82815-5629	92815-5629	92818-5629
Fair / Rizzini	Express	62815-5691	72815-5691	82815-5691	92815-5691	92818-5691
FN Browning	A-Bolt	62815-5620	72815-5620	82815-5620	92815-5620	92818-5620
	A-Bolt III	62815-562T	72815-562T	82815-562T	92815-562T	92818-562T
	A-Bolt WSSM	62815-561G	72815-561G	82815-561G	92815-561G	92818-561G
	BAR / BLR / CBL / Acera	62815-5603	72815-5603	82815-5603	92815-5603	92818-5603
	Eurobolt	62815-5678	72815-5678	82815-5678	92815-5678	92818-5678
	European	62815-5656	72815-5656	82815-5656	92815-5656	92818-5656
	Maral	62815-562J	72815-562J	82815-562J	92815-562J	92818-562J
	X-Bolt	62815-561P	72815-561P	82815-561P	92815-561P	92818-561P
Haenel	Jäger 10 (bis Serien-Nr. JX-000920)	62815-561W	72815-561W	82815-561W	92815-561W	92818-561W
	Jäger 10 (ab Serien-Nr. JX-000921)	62815-562C	72815-562C	82815-562C	92815-562C	92818-562C
	SLB 2000+	62815-562I	72815-562I	82815-562I	92815-562I	92818-562I
H&K	SLB 2000	62815-5608	72815-5608	82815-5608	92815-5608	92818-5608
Heym	SR 20	62815-5660	72815-5660	82815-5660	92815-5660	92818-5660
	SR 21	62815-5622	72815-5622	82815-5622	92815-5622	92818-5622
	SR 30	62815-5690	72815-5690	82815-5690	92815-5690	92818-5690
Howa	1500	62815-5659	72815-5659	82815-5659	92815-5659	92818-5659
Krico	600 / 700 / 900 / 902 Deluxe	62815-5606	72815-5606	82815-5606	92815-5606	92818-5606
Krieghoff	Semprio	62815-561C	72815-561C	82815-561C	92815-561C	92818-561C
Mauser	66	62815-5609	72815-5609	82815-5609	92815-5609	92818-5609
	M 94	62815-5694	72815-5694	82815-5694	92815-5694	92818-5694
	M 96	62815-5696	72815-5696	82815-5696	92815-5696	92818-5696
	M 96 (ab Serien-Nr. 12000) / M 97	62815-5697	72815-5697	82815-5697	92815-5697	92818-5697
	K 98 (und Nachbauten)	62815-5610	72815-5610	82815-5610	92815-5610	92818-5610
	M 12	62815-562L	72815-562L	82815-562L	92815-562L	92818-562L
Merkel	SR1	62815-5698	72815-5698	82815-5698	92815-5698	92818-5698
	SR1 Basic	62815-562D	72815-562D	82815-562D	92815-562D	92818-562D
Remington	700 (Gewinde UNS 6-48)	62815-5612	72815-5612	82815-5612	92815-5612	92818-5612
	700 (Gewinde UNS 8-40)	62815-561N	72815-561N	82815-561N	92815-561N	92818-561N
	783	62815-5625	72815-5625	82815-5625	92815-5625	92818-5625
	7400 / 7600 / 750	62815-5613	72815-5613	82815-5613	92815-5613	92818-5613
	Seven	62815-5619	72815-5619	82815-5619	92815-5619	92818-5619
RWS-Rößler	Titan 3 / Titan 6 / Titan α	62815-5692	72815-5692	82815-5692	92815-5692	92818-5692
	Titan 16	62815-562G	72815-562G	82815-562G	92815-562G	92818-562G
Sabatti	Express	62815-561K	72815-561K	82815-561K	92815-561K	92818-561K
Sako	konisches Prisma / tapered dovetail	62815-5653	72815-5653	82815-5653	92815-5653	92818-5653
Sauer	80 / 90 / 92	62815-5615	72815-5615	82815-5615	92815-5615	92818-5615
	101	62815-562K	72815-562K	82815-562K	92815-562K	92818-562K
	200	62815-5616	72815-5616	82815-5616	92815-5616	92818-5616
	202	62815-5680	72815-5680	82815-5680	92815-5680	92818-5680
Savage	ebene Hülsenbrücke / flat Top	62815-5635	72815-5635	82815-5635	92815-5635	92818-5635
	gerundete Hülsenbrücke / rounded Top	62815-5693	72815-5693	82815-5693	92815-5693	92818-5693
Steyr-Mannlicher	Luxus (siehe Katalog auf Seite 61)					
	SBS-96	62815-5687	72815-5687	82815-5687	92815-5687	92818-5687
	SBS-96 Export/Pro Hunter/Classic/SM12/CLII	62815-5688	72815-5688	82815-5688	92815-5688	92818-5688
Swiss Arms	SHR-970 (Bohrungsabstand 21,9 mm)	62815-5640	72815-5640	82815-5640	92815-5640	92818-5640
Tikka	T3	62815-5681	72815-5681	82815-5681	92815-5681	92818-5681
Verney-Carron	Impact NT / Plus	62815-5647	72815-5647	82815-5647	92815-5647	92818-5647
Voere	LBW	62815-5655	72815-5655	82815-5655	92815-5655	92818-5655
Weatherby	Mark V / 300 / Vanguard	62815-5623	72815-5623	82815-5623	92815-5623	92818-5623
Winchester	70 short / long action	62815-5624	72815-5624	82815-5624	92815-5624	92818-5624
	70 Magnum (Baujahr nach 1964)	62815-5625	72815-5625	82815-5625	92815-5625	92818-5625
	70 WSM	62815-5611	72815-5611	82815-5611	92815-5611	92818-5611
	70 WSSM	62815-5669	72815-5669	82815-5669	92815-5669	92818-5669
	SXR Vulcan	62815-561J	72815-561J	82815-561J	92815-561J	92818-561J
Zastava	70	62815-5601	72815-5601	82815-5601	92815-5601	92818-5601

ERAMATIC®-SCHWENKMONTAGEN mit Stahl-Klemmringsen ø 34 mm

ERAMATIC®-Swing mounts with steel rings ø 34 mm

Ausführungen / Models:

- **Mögliche Verlängerungen:** ohne bzw. mit 26 mm, 31 mm, 44 mm und 56 mm
Available extensions: none (short), 26 mm, 31 mm, 44 mm and 56 mm
- **Bauhöhe / Height:** 18,5 mm
- **Ringbreite / Ring width:** 15,0 mm

Eramatic® Verschlussvarianten: Eramatic® lock-up systems:

- R6:** Verschlusskörper mit automatischer Verriegelungstechnik.
Für Prismenbasen und Schienenplatten mit 30°-Prisma.
Rotary locking system with automatic locking mechanism.
Fits all 30° rear dovetail bases and 30° rails.
- H7:** Verschlusskörper mit Entriegelungssicherung mittels Sperrklinke.
Für Prismenbasen und Schienenplatten mit 30°-Prisma.
Locking system with lever and integrated safety catch.
Fits all 30° rear dovetail bases and 30° rails.
- V8:** Verschlusskörper mit Doppelstangenverschluss.
Für Prismenbasen und Schienenplatten mit 20°-Prisma.
Locking system with self-locking clamp.
Fits all 20° rear bases and 20° rails.
- G9:** Verschlusskörper mit integriertem Kurvenspannsystem.
Für Prismenbasen und Schienenplatten mit 30°-Prisma und 15 mm Breite
sowie für 30° Laufschiene mit 12 mm und 14 mm Prismenbreite.
Rotary locking system.
Fits all 30° rear bases and 30° rails with a width of 12 mm, 14 mm or 15 mm.
- G9-Plus:** Verschlusskörper mit integriertem Kurvenspannsystem und geriffeltem Daumennocken.
Für Prismenbasen und Schienenplatten mit 30°-Prisma und 15 mm Breite.
Rotary locking system, specially shaped for easy handling.
Fits all 30° rear bases and 30° rails with a width of 15 mm.

Swing mounts with steel rings ø 34 mm / Montages pivotants avec colliers ø 34 mm

- ø 34 mm
- kurze Ausführung
- Bauhöhe: 18,5 mm
- Klemmringe aus Stahl
- Ringbreite 15 mm

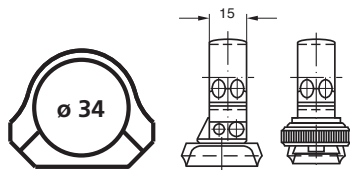

wahlweise mit folgenden ERAMATIC-Verschlüssen lieferbar:

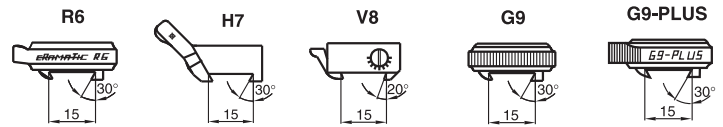

Anschütz	1780 / 1781	63415-002B	73415-002B	83415-002B	93415-002B	93418-002B
Antonio Zoli	1900	63415-0089	73415-0089	83415-0089	93415-0089	93418-0089
Benelli	ARGO	63415-0076	73415-0076	83415-0076	93415-0076	93418-0076
Beretta	689 gold sable / silver sable 2	63415-0099	73415-0099	83415-0099	93415-0099	93418-0099
Brünnner CZ	Prisma 16,0 mm	63415-0061	73415-0061	83415-0061	93415-0061	93418-0061
	Prisma 19,5 mm	63415-0062	73415-0062	83415-0062	93415-0062	93418-0062
Chapuis	Express	63415-0029	73415-0029	83415-0029	93415-0029	93418-0029
Fair / Rizzini	Express	63415-0091	73415-0091	83415-0091	93415-0091	93418-0091
FN Browning	A-Bolt	63415-0020	73415-0020	83415-0020	93415-0020	93418-0020
	A-Bolt III	63415-002T	73415-002T	83415-002T	93415-002T	93418-002T
	A-Bolt WSSM	63415-001G	73415-001G	83415-001G	93415-001G	93418-001G
	BAR / BLR / CBL / Acera	63415-0003	73415-0003	83415-0003	93415-0003	93418-0003
	Eurobolt	63415-0078	73415-0078	83415-0078	93415-0078	93418-0078
	European	63415-0056	73415-0056	83415-0056	93415-0056	93418-0056
	Maral	63415-002J	73415-002J	83415-002J	93415-002J	93418-002J
	X-Bolt	63415-001P	73415-001P	83415-001P	93415-001P	93418-001P
Haenel	Jäger 10 (bis Serien-Nr. JX-000920)	63415-001W	73415-001W	83415-001W	93415-001W	93418-001W
	Jäger 10 (ab Serien-Nr. JX-000921)	63415-002C	73415-002C	83415-002C	93415-002C	93418-002C
	SLB 2000+	63415-002I	73415-002I	83415-002I	93415-002I	93418-002I
H&K	SLB 2000	63415-0008	73415-0008	83415-0008	93415-0008	93418-0008
Heym	SR 20	63415-0060	73415-0060	83415-0060	93415-0060	93418-0060
	SR 21	63415-0022	73415-0022	83415-0022	93415-0022	93418-0022
	SR 30	63415-0090	73415-0090	83415-0090	93415-0090	93418-0090
Howa	1500	63415-0059	73415-0059	83415-0059	93415-0059	93418-0059
Krico	600 / 700 / 900 / 902 Deluxe	63415-0006	73415-0006	83415-0006	93415-0006	93418-0006
Krieghoff	Semprio	63415-001C	73415-001C	83415-001C	93415-001C	93418-001C
Mauser	66	63415-0009	73415-0009	83415-0009	93415-0009	93418-0009
	M 94	63415-0094	73415-0094	83415-0094	93415-0094	93418-0094
	M 96	63415-0096	73415-0096	83415-0096	93415-0096	93418-0096
	M 96 (ab Serien-Nr. 12000) / M 97	63415-0097	73415-0097	83415-0097	93415-0097	93418-0097
	K 98 (und Nachbauten)	63415-0010	73415-0010	83415-0010	93415-0010	93418-0010
	M 12	63415-002L	73415-002L	83415-002L	93415-002L	93418-002L
Merkel	SR1	63415-0098	73415-0098	83415-0098	93415-0098	93418-0098
	SR1 Basic	63415-002D	73415-002D	83415-002D	93415-002D	93418-002D
Remington	700 (Gewinde UNS 6-48)	63415-0012	73415-0012	83415-0012	93415-0012	93418-0012
	700 (Gewinde UNS 8-40)	63415-001N	73415-001N	83415-001N	93415-001N	93418-001N
	783	63415-0025	73415-0025	83415-0025	93415-0025	93418-0025
	7400 / 7600 / 750	63415-0013	73415-0013	83415-0013	93415-0013	93418-0013
	Seven	63415-0019	73415-0019	83415-0019	93415-0019	93418-0019
RWS-Rößler	Titan 3 / Titan 6 / Titan α	63415-0092	73415-0092	83415-0092	93415-0092	93418-0092
	Titan 16	63415-002G	73415-002G	83415-002G	93415-002G	93418-002G
Sabatti	Express	63415-001K	73415-001K	83415-001K	93415-001K	93418-001K
Sako	konisches Prisma / tapered dovetail	63415-0053	73415-0053	83415-0053	93415-0053	93418-0053
Sauer	80 / 90 / 92	63415-0015	73415-0015	83415-0015	93415-0015	93418-0015
	101	63415-002K	73415-002K	83415-002K	93415-002K	93418-002K
	200	63415-0016	73415-0016	83415-0016	93415-0016	93418-0016
	202	63415-0080	73415-0080	83415-0080	93415-0080	93418-0080
Savage	ebene Hülsenbrücke / flat Top	63415-0035	73415-0035	83415-0035	93415-0035	93418-0035
	gerundete Hülsenbrücke / rounded Top	63415-0093	73415-0093	83415-0093	93415-0093	93418-0093
Steyr-Mannlicher	Luxus (siehe Katalog auf Seite 61)					
	SBS-96	63415-0087	73415-0087	83415-0087	93415-0087	93418-0087
	SBS-96 Export/Pro Hunter/Classic/SM12/CLII	63415-0088	73415-0088	83415-0088	93415-0088	93418-0088
Swiss Arms	SHR-970 (Bohrungsabstand 21,9 mm)	63415-0040	73415-0040	83415-0040	93415-0040	93418-0040
Tikka	T3	63415-0081	73415-0081	83415-0081	93415-0081	93418-0081
Verney-Carron	Impact NT / Plus	63415-0047	73415-0047	83415-0047	93415-0047	93418-0047
Voere	LBW	63415-0055	73415-0055	83415-0055	93415-0055	93418-0055
Weatherby	Mark V / 300 / Vanguard	63415-0023	73415-0023	83415-0023	93415-0023	93418-0023
Winchester	70 short / long action	63415-0024	73415-0024	83415-0024	93415-0024	93418-0024
	70 Magnum (Baujahr nach 1964)	63415-0025	73415-0025	83415-0025	93415-0025	93418-0025
	70 WSM	63415-0011	73415-0011	83415-0011	93415-0011	93418-0011
	70 WSSM	63415-0069	73415-0069	83415-0069	93415-0069	93418-0069
	SXR Vulcan	63415-001J	73415-001J	83415-001J	93415-001J	93418-001J
Zastava	70	63415-0001	73415-0001	83415-0001	93415-0001	93418-0001

Swing mounts with steel rings ø 34 mm / Montages pivotants avec colliers ø 34 mm

- ø 34 mm
- Verlängerung 26 mm
- Bauhöhe: 18,5 mm
- Klemmringse aus Stahl
- Ringbreite 15 mm

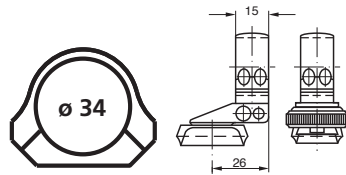

wahlweise mit folgenden ERAMATIC-Verschlüssen lieferbar:

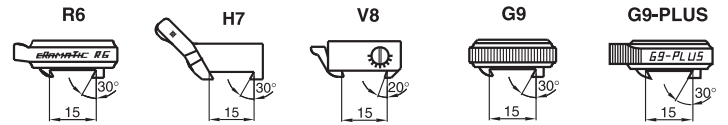

Anschütz	1780 / 1781	63415-262B	73415-262B	83415-262B	93415-262B	93418-262B
Antonio Zoli	1900	63415-2689	73415-2689	83415-2689	93415-2689	93418-2689
Benelli	ARGO	63415-2676	73415-2676	83415-2676	93415-2676	93418-2676
Beretta	689 gold sable / silver sable 2	63415-2699	73415-2699	83415-2699	93415-2699	93418-2699
Brünnner CZ	Prisma 16,0 mm	63415-2661	73415-2661	83415-2661	93415-2661	93418-2661
	Prisma 19,5 mm	63415-2662	73415-2662	83415-2662	93415-2662	93418-2662
Chapuis	Express	63415-2629	73415-2629	83415-2629	93415-2629	93418-2629
Fair / Rizzini	Express	63415-2691	73415-2691	83415-2691	93415-2691	93418-2691
FN Browning	A-Bolt	63415-2620	73415-2620	83415-2620	93415-2620	93418-2620
	A-Bolt III	63415-262T	73415-262T	83415-262T	93415-262T	93418-262T
	A-Bolt WSSM	63415-261G	73415-261G	83415-261G	93415-261G	93418-261G
	BAR / BLR / CBL / Acera	63415-2603	73415-2603	83415-2603	93415-2603	93418-2603
	Eurobolt	63415-2678	73415-2678	83415-2678	93415-2678	93418-2678
	European	63415-2656	73415-2656	83415-2656	93415-2656	93418-2656
	Maral	63415-262J	73415-262J	83415-262J	93415-262J	93418-262J
	X-Bolt	63415-261P	73415-261P	83415-261P	93415-261P	93418-261P
Haenel	Jäger 10 (bis Serien-Nr. JX-000920)	63415-261W	73415-261W	83415-261W	93415-261W	93418-261W
	Jäger 10 (ab Serien-Nr. JX-000921)	63415-262C	73415-262C	83415-262C	93415-262C	93418-262C
	SLB 2000+	63415-262I	73415-262I	83415-262I	93415-262I	93418-262I
H&K	SLB 2000	63415-2608	73415-2608	83415-2608	93415-2608	93418-2608
Heym	SR 20	63415-2660	73415-2660	83415-2660	93415-2660	93418-2660
	SR 21	63415-2622	73415-2622	83415-2622	93415-2622	93418-2622
	SR 30	63415-2690	73415-2690	83415-2690	93415-2690	93418-2690
Howa	1500	63415-2659	73415-2659	83415-2659	93415-2659	93418-2659
Krico	600 / 700 / 900 / 902 Deluxe	63415-2606	73415-2606	83415-2606	93415-2606	93418-2606
Krieghoff	Semprio	63415-261C	73415-261C	83415-261C	93415-261C	93418-261C
Mauser	66	63415-2609	73415-2609	83415-2609	93415-2609	93418-2609
	M 94	63415-2694	73415-2694	83415-2694	93415-2694	93418-2694
	M 96	63415-2696	73415-2696	83415-2696	93415-2696	93418-2696
	M 96 (ab Serien-Nr. 12000) / M 97	63415-2697	73415-2697	83415-2697	93415-2697	93418-2697
	K 98 (und Nachbauten)	63415-2610	73415-2610	83415-2610	93415-2610	93418-2610
	M 12	63415-262L	73415-262L	83415-262L	93415-262L	93418-262L
Merkel	SR1	63415-2698	73415-2698	83415-2698	93415-2698	93418-2698
	SR1 Basic	63415-262D	73415-262D	83415-262D	93415-262D	93418-262D
Remington	700 (Gewinde UNS 6-48)	63415-2612	73415-2612	83415-2612	93415-2612	93418-2612
	700 (Gewinde UNS 8-40)	63415-261N	73415-261N	83415-261N	93415-261N	93418-261N
	783	63415-2625	73415-2625	83415-2625	93415-2625	93418-2625
	7400 / 7600 / 750	63415-2613	73415-2613	83415-2613	93415-2613	93418-2613
	Seven	63415-2619	73415-2619	83415-2619	93415-2619	93418-2619
RWS-Rößler	Titan 3 / Titan 6 / Titan α	63415-2692	73415-2692	83415-2692	93415-2692	93418-2692
	Titan 16	63415-262G	73415-262G	83415-262G	93415-262G	93418-262G
Sabatti	Express	63415-261K	73415-261K	83415-261K	93415-261K	93418-261K
Sako	konisches Prisma / tapered dovetail	63415-2653	73415-2653	83415-2653	93415-2653	93418-2653
Sauer	80 / 90 / 92	63415-2615	73415-2615	83415-2615	93415-2615	93418-2615
	101	63415-262K	73415-262K	83415-262K	93415-262K	93418-262K
	200	63415-2616	73415-2616	83415-2616	93415-2616	93418-2616
	202	63415-2680	73415-2680	83415-2680	93415-2680	93418-2680
Savage	ebene Hülsenbrücke / flat Top	63415-2635	73415-2635	83415-2635	93415-2635	93418-2635
	gerundete Hülsenbrücke / rounded Top	63415-2693	73415-2693	83415-2693	93415-2693	93418-2693
Steyr-Mannlicher	Luxus (siehe Katalog auf Seite 61)					
	SBS-96	63415-2687	73415-2687	83415-2687	93415-2687	93418-2687
	SBS-96 Export/Pro Hunter/Classic/SM12/CLII	63415-2688	73415-2688	83415-2688	93415-2688	93418-2688
Swiss Arms	SHR-970 (Bohrungsabstand 21,9 mm)	63415-2640	73415-2640	83415-2640	93415-2640	93418-2640
Tikka	T3	63415-2681	73415-2681	83415-2681	93415-2681	93418-2681
Verney-Carron	Impact NT / Plus	63415-2647	73415-2647	83415-2647	93415-2647	93418-2647
Voere	LBW	63415-2655	73415-2655	83415-2655	93415-2655	93418-2655
Weatherby	Mark V / 300 / Vanguard	63415-2623	73415-2623	83415-2623	93415-2623	93418-2623
Winchester	70 short / long action	63415-2624	73415-2624	83415-2624	93415-2624	93418-2624
	70 Magnum (Baujahr nach 1964)	63415-2625	73415-2625	83415-2625	93415-2625	93418-2625
	70 WSM	63415-2611	73415-2611	83415-2611	93415-2611	93418-2611
	70 WSSM	63415-2669	73415-2669	83415-2669	93415-2669	93418-2669
	SRX Vulcan	63415-261J	73415-261J	83415-261J	93415-261J	93418-261J
Zastava	70	63415-2601	73415-2601	83415-2601	93415-2601	93418-2601

Swing mounts with steel rings ø 34 mm / Montages pivotants avec colliers ø 34 mm

- ø 34 mm
- Verlängerung 31 mm
- Bauhöhe: 18,5 mm
- Klemmringe aus Stahl
- Ringbreite 15 mm

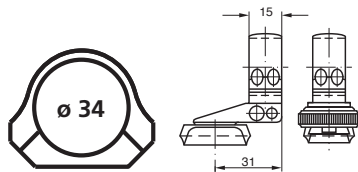

wahlweise mit folgenden ERAMATIC-Verschlüssen lieferbar:

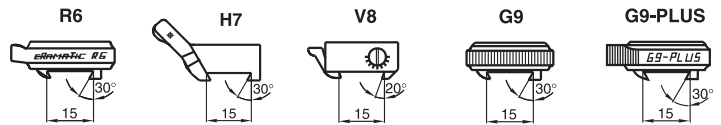

Anschütz	1780 / 1781	63415-312B	73415-312B	83415-312B	93415-312B	93418-312B
Antonio Zoli	1900	63415-3189	73415-3189	83415-3189	93415-3189	93418-3189
Benelli	ARGO	63415-3176	73415-3176	83415-3176	93415-3176	93418-3176
Beretta	689 gold sable / silver sable 2	63415-3199	73415-3199	83415-3199	93415-3199	93418-3199
Brünnner CZ	Prisma 16,0 mm	63415-3161	73415-3161	83415-3161	93415-3161	93418-3161
	Prisma 19,5 mm	63415-3162	73415-3162	83415-3162	93415-3162	93418-3162
Chapuis	Express	63415-3129	73415-3129	83415-3129	93415-3129	93418-3129
Fair / Rizzini	Express	63415-3191	73415-3191	83415-3191	93415-3191	93418-3191
FN Browning	A-Bolt	63415-3120	73415-3120	83415-3120	93415-3120	93418-3120
	A-Bolt III	63415-312T	73415-312T	83415-312T	93415-312T	93418-312T
	A-Bolt WSSM	63415-311G	73415-311G	83415-311G	93415-311G	93418-311G
	BAR / BLR / CBL / Acera	63415-3103	73415-3103	83415-3103	93415-3103	93418-3103
	Eurobolt	63415-3178	73415-3178	83415-3178	93415-3178	93418-3178
	European	63415-3156	73415-3156	83415-3156	93415-3156	93418-3156
	Maral	63415-312J	73415-312J	83415-312J	93415-312J	93418-312J
	X-Bolt	63415-311P	73415-311P	83415-311P	93415-311P	93418-311P
Haenel	Jäger 10 (bis Serien-Nr. JX-000920)	63415-311W	73415-311W	83415-311W	93415-311W	93418-311W
	Jäger 10 (ab Serien-Nr. JX-000921)	63415-312C	73415-312C	83415-312C	93415-312C	93418-312C
	SLB 2000+	63415-312I	73415-312I	83415-312I	93415-312I	93418-312I
H&K	SLB 2000	63415-3108	73415-3108	83415-3108	93415-3108	93418-3108
Heym	SR 20	63415-3160	73415-3160	83415-3160	93415-3160	93418-3160
	SR 21	63415-3122	73415-3122	83415-3122	93415-3122	93418-3122
	SR 30	63415-3190	73415-3190	83415-3190	93415-3190	93418-3190
Howa	1500	63415-3159	73415-3159	83415-3159	93415-3159	93418-3159
Krico	600 / 700 / 900 / 902 Deluxe	63415-3106	73415-3106	83415-3106	93415-3106	93418-3106
Krieghoff	Semprio	63415-311C	73415-311C	83415-311C	93415-311C	93418-311C
Mauser	66	63415-3109	73415-3109	83415-3109	93415-3109	93418-3109
	M 94	63415-3194	73415-3194	83415-3194	93415-3194	93418-3194
	M 96	63415-3196	73415-3196	83415-3196	93415-3196	93418-3196
	M 96 (ab Serien-Nr. 12000) / M 97	63415-3197	73415-3197	83415-3197	93415-3197	93418-3197
	K 98 (und Nachbauten)	63415-3110	73415-3110	83415-3110	93415-3110	93418-3110
	M 12	63415-312L	73415-312L	83415-312L	93415-312L	93418-312L
Merkel	SR1	63415-3198	73415-3198	83415-3198	93415-3198	93418-3198
	SR1 Basic	63415-312D	73415-312D	83415-312D	93415-312D	93418-312D
Remington	700 (Gewinde UNS 6-48)	63415-3112	73415-3112	83415-3112	93415-3112	93418-3112
	700 (Gewinde UNS 8-40)	63415-311N	73415-311N	83415-311N	93415-311N	93418-311N
	783	63415-3125	73415-3125	83415-3125	93415-3125	93418-3125
	7400 / 7600 / 750	63415-3113	73415-3113	83415-3113	93415-3113	93418-3113
	Seven	63415-3119	73415-3119	83415-3119	93415-3119	93418-3119
RWS-Rößler	Titan 3 / Titan 6 / Titan α	63415-3192	73415-3192	83415-3192	93415-3192	93418-3192
	Titan 16	63415-312G	73415-312G	83415-312G	93415-312G	93418-312G
Sabatti	Express	63415-311K	73415-311K	83415-311K	93415-311K	93418-311K
Sako	konisches Prisma / tapered dovetail	63415-3153	73415-3153	83415-3153	93415-3153	93418-3153
Sauer	80 / 90 / 92	63415-3115	73415-3115	83415-3115	93415-3115	93418-3115
	101	63415-312K	73415-312K	83415-312K	93415-312K	93418-312K
	200	63415-3116	73415-3116	83415-3116	93415-3116	93418-3116
	202	63415-3180	73415-3180	83415-3180	93415-3180	93418-3180
Savage	ebene Hülsenbrücke / flat Top	63415-3135	73415-3135	83415-3135	93415-3135	93418-3135
	gerundete Hülsenbrücke / rounded Top	63415-3193	73415-3193	83415-3193	93415-3193	93418-3193
Steyr-Mannlicher	Luxus (siehe Katalog auf Seite 61)					
	SBS-96	63415-3187	73415-3187	83415-3187	93415-3187	93418-3187
	SBS-96 Export/Pro Hunter/Classic/SM12/CLII	63415-3188	73415-3188	83415-3188	93415-3188	93418-3188
Swiss Arms	SHR-970 (Bohrungsabstand 21,9 mm)	63415-3140	73415-3140	83415-3140	93415-3140	93418-3140
Tikka	T3	63415-3181	73415-3181	83415-3181	93415-3181	93418-3181
Verney-Carron	Impact NT / Plus	63415-3147	73415-3147	83415-3147	93415-3147	93418-3147
Voere	LBW	63415-3155	73415-3155	83415-3155	93415-3155	93418-3155
Weatherby	Mark V / 300 / Vanguard	63415-3123	73415-3123	83415-3123	93415-3123	93418-3123
Winchester	70 short / long action	63415-3124	73415-3124	83415-3124	93415-3124	93418-3124
	70 Magnum (Baujahr nach 1964)	63415-3125	73415-3125	83415-3125	93415-3125	93418-3125
	70 WSM	63415-3111	73415-3111	83415-3111	93415-3111	93418-3111
	70 WSSM	63415-3169	73415-3169	83415-3169	93415-3169	93418-3169
	SXR Vulcan	63415-311J	73415-311J	83415-311J	93415-311J	93418-311J
Zastava	70	63415-3101	73415-3101	83415-3101	93415-3101	93418-3101

Swing mounts with steel rings ø 34 mm / Montages pivotants avec colliers ø 34 mm

- ø 34 mm
- Verlängerung 44 mm
- Bauhöhe: 18,5 mm
- Klemmringe aus Stahl
- Ringbreite 15 mm

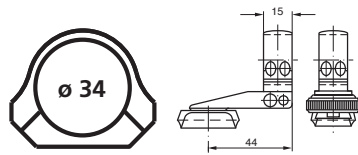

wahlweise mit folgenden ERAMATIC-Verschlüssen lieferbar:

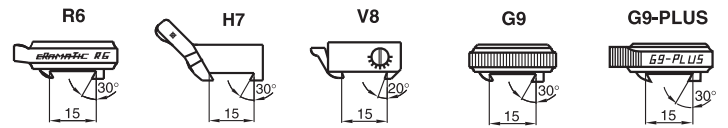

Anschütz	1780 / 1781	63415-442B	73415-442B	83415-442B	93415-442B	93418-442B
Antonio Zoli	1900	63415-4489	73415-4489	83415-4489	93415-4489	93418-4489
Benelli	ARGO	63415-4476	73415-4476	83415-4476	93415-4476	93418-4476
Beretta	689 gold sable / silver sable 2	63415-4499	73415-4499	83415-4499	93415-4499	93418-4499
Brügger CZ	Prisma 16,0 mm	63415-4461	73415-4461	83415-4461	93415-4461	93418-4461
	Prisma 19,5 mm	63415-4462	73415-4462	83415-4462	93415-4462	93418-4462
Chapuis	Express	63415-4429	73415-4429	83415-4429	93415-4429	93418-4429
Fair / Rizzini	Express	63415-4491	73415-4491	83415-4491	93415-4491	93418-4491
FN Browning	A-Bolt	63415-4420	73415-4420	83415-4420	93415-4420	93418-4420
	A-Bolt III	63415-442T	73415-442T	83415-442T	93415-442T	93418-442T
	A-Bolt WSSM	63415-441G	73415-441G	83415-441G	93415-441G	93418-441G
	BAR / BLR / CBL / Acera	63415-4403	73415-4403	83415-4403	93415-4403	93418-4403
	Eurobolt	63415-4478	73415-4478	83415-4478	93415-4478	93418-4478
	European	63415-4456	73415-4456	83415-4456	93415-4456	93418-4456
	Maral	63415-442J	73415-442J	83415-442J	93415-442J	93418-442J
	X-Bolt	63415-441P	73415-441P	83415-441P	93415-441P	93418-441P
Haenel	Jäger 10 (bis Serien-Nr. JX-000920)	63415-441W	73415-441W	83415-441W	93415-441W	93418-441W
	Jäger 10 (ab Serien-Nr. JX-000921)	63415-442C	73415-442C	83415-442C	93415-442C	93418-442C
	SLB 2000+	63415-442I	73415-442I	83415-442I	93415-442I	93418-442I
H&K	SLB 2000	63415-4408	73415-4408	83415-4408	93415-4408	93418-4408
Heym	SR 20	63415-4460	73415-4460	83415-4460	93415-4460	93418-4460
	SR 21	63415-4422	73415-4422	83415-4422	93415-4422	93418-4422
	SR 30	63415-4490	73415-4490	83415-4490	93415-4490	93418-4490
Howa	1500	63415-4459	73415-4459	83415-4459	93415-4459	93418-4459
Krico	600 / 700 / 900 / 902 Deluxe	63415-4406	73415-4406	83415-4406	93415-4406	93418-4406
Krieghoff	Semprio	63415-441C	73415-441C	83415-441C	93415-441C	93418-441C
Mauser	66	63415-4409	73415-4409	83415-4409	93415-4409	93418-4409
	M 94	63415-4494	73415-4494	83415-4494	93415-4494	93418-4494
	M 96	63415-4496	73415-4496	83415-4496	93415-4496	93418-4496
	M 96 (ab Serien-Nr. 12000) / M 97	63415-4497	73415-4497	83415-4497	93415-4497	93418-4497
	K 98 (und Nachbauten)	63415-4410	73415-4410	83415-4410	93415-4410	93418-4410
	M 12	63415-442L	73415-442L	83415-442L	93415-442L	93418-442L
Merkel	SR1	63415-4498	73415-4498	83415-4498	93415-4498	93418-4498
	SR1 Basic	63415-442D	73415-442D	83415-442D	93415-442D	93418-442D
Remington	700 (Gewinde UNS 6-48)	63415-4412	73415-4412	83415-4412	93415-4412	93418-4412
	700 (Gewinde UNS 8-40)	63415-441N	73415-441N	83415-441N	93415-441N	93418-441N
	783	63415-4425	73415-4425	83415-4425	93415-4425	93418-4425
	7400 / 7600 / 750	63415-4413	73415-4413	83415-4413	93415-4413	93418-4413
	Seven	63415-4419	73415-4419	83415-4419	93415-4419	93418-4419
RWS-Rößler	Titan 3 / Titan 6 / Titan α	63415-4492	73415-4492	83415-4492	93415-4492	93418-4492
	Titan 16	63415-442G	73415-442G	83415-442G	93415-442G	93418-442G
Sabatti	Express	63415-441K	73415-441K	83415-441K	93415-441K	93418-441K
Sako	konisches Prisma / tapered dovetail	63415-4453	73415-4453	83415-4453	93415-4453	93418-4453
Sauer	80 / 90 / 92	63415-4415	73415-4415	83415-4415	93415-4415	93418-4415
	101	63415-442K	73415-442K	83415-442K	93415-442K	93418-442K
	200	63415-4416	73415-4416	83415-4416	93415-4416	93418-4416
	202	63415-4480	73415-4480	83415-4480	93415-4480	93418-4480
Savage	ebene Hülsenbrücke / flat Top	63415-4435	73415-4435	83415-4435	93415-4435	93418-4435
	gerundete Hülsenbrücke / rounded Top	63415-4493	73415-4493	83415-4493	93415-4493	93418-4493
Steyr-Mannlicher	Luxus (siehe Katalog auf Seite 61)					
	SBS-96	63415-4487	73415-4487	83415-4487	93415-4487	93418-4487
	SBS-96 Export/Pro Hunter/Classic/SM12/CLII	63415-4488	73415-4488	83415-4488	93415-4488	93418-4488
Swiss Arms	SHR-970 (Bohrungsabstand 21,9 mm)	63415-4440	73415-4440	83415-4440	93415-4440	93418-4440
Tikka	T3	63415-4481	73415-4481	83415-4481	93415-4481	93418-4481
Verney-Carron	Impact NT / Plus	63415-4447	73415-4447	83415-4447	93415-4447	93418-4447
Voere	LBW	63415-4455	73415-4455	83415-4455	93415-4455	93418-4455
Weatherby	Mark V / 300 / Vanguard	63415-4423	73415-4423	83415-4423	93415-4423	93418-4423
Winchester	70 short / long action	63415-4424	73415-4424	83415-4424	93415-4424	93418-4424
	70 Magnum (Baujahr nach 1964)	63415-4425	73415-4425	83415-4425	93415-4425	93418-4425
	70 WSM	63415-4411	73415-4411	83415-4411	93415-4411	93418-4411
	70 WSSM	63415-4469	73415-4469	83415-4469	93415-4469	93418-4469
	SXR Vulcan	63415-441J	73415-441J	83415-441J	93415-441J	93418-441J
Zastava	70	63415-4401	73415-4401	83415-4401	93415-4401	93418-4401

Swing mounts with steel rings ø 34 mm / Montages pivotants avec colliers ø 34 mm

- ø 34 mm
- Verlängerung 56 mm
- Bauhöhe: 18,5 mm
- Klemmringe aus Stahl
- Ringbreite 15 mm

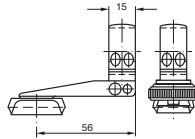

wahlweise mit folgenden ERAMATIC-Verschlüssen lieferbar:

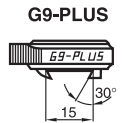
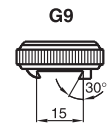
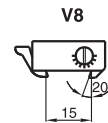
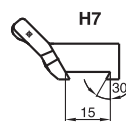
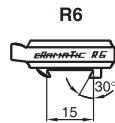

Anschütz	1780 / 1781	63415-562B	73415-562B	83415-562B	93415-562B	93418-562B
Antonio Zoli	1900	63415-5689	73415-5689	83415-5689	93415-5689	93418-5689
Benelli	ARGO	63415-5676	73415-5676	83415-5676	93415-5676	93418-5676
Beretta	689 gold sable / silver sable 2	63415-5699	73415-5699	83415-5699	93415-5699	93418-5699
Brünnner CZ	Prisma 16,0 mm	63415-5661	73415-5661	83415-5661	93415-5661	93418-5661
	Prisma 19,5 mm	63415-5662	73415-5662	83415-5662	93415-5662	93418-5662
Chapuis	Express	63415-5629	73415-5629	83415-5629	93415-5629	93418-5629
Fair / Rizzini	Express	63415-5691	73415-5691	83415-5691	93415-5691	93418-5691
FN Browning	A-Bolt	63415-5620	73415-5620	83415-5620	93415-5620	93418-5620
	A-Bolt III	63415-562T	73415-562T	83415-562T	93415-562T	93418-562T
	A-Bolt WSSM	63415-561G	73415-561G	83415-561G	93415-561G	93418-561G
	BAR / BLR / CBL / Acera	63415-5603	73415-5603	83415-5603	93415-5603	93418-5603
	Eurobolt	63415-5678	73415-5678	83415-5678	93415-5678	93418-5678
	European	63415-5656	73415-5656	83415-5656	93415-5656	93418-5656
	Maral	63415-562J	73415-562J	83415-562J	93415-562J	93418-562J
	X-Bolt	63415-561P	73415-561P	83415-561P	93415-561P	93418-561P
Haenel	Jäger 10 (bis Serien-Nr. JX-000920)	63415-561W	73415-561W	83415-561W	93415-561W	93418-561W
	Jäger 10 (ab Serien-Nr. JX-000921)	63415-562C	73415-562C	83415-562C	93415-562C	93418-562C
	SLB 2000+	63415-562I	73415-562I	83415-562I	93415-562I	93418-562I
H&K	SLB 2000	63415-5608	73415-5608	83415-5608	93415-5608	93418-5608
Heym	SR 20	63415-5660	73415-5660	83415-5660	93415-5660	93418-5660
	SR 21	63415-5622	73415-5622	83415-5622	93415-5622	93418-5622
	SR 30	63415-5690	73415-5690	83415-5690	93415-5690	93418-5690
Howa	1500	63415-5659	73415-5659	83415-5659	93415-5659	93418-5659
Krico	600 / 700 / 900 / 902 Deluxe	63415-5606	73415-5606	83415-5606	93415-5606	93418-5606
Krieghoff	Semprio	63415-561C	73415-561C	83415-561C	93415-561C	93418-561C
Mauser	66	63415-5609	73415-5609	83415-5609	93415-5609	93418-5609
	M 94	63415-5694	73415-5694	83415-5694	93415-5694	93418-5694
	M 96	63415-5696	73415-5696	83415-5696	93415-5696	93418-5696
	M 96 (ab Serien-Nr. 12000) / M 97	63415-5697	73415-5697	83415-5697	93415-5697	93418-5697
	K 98 (und Nachbauten)	63415-5610	73415-5610	83415-5610	93415-5610	93418-5610
	M 12	63415-562L	73415-562L	83415-562L	93415-562L	93418-562L
Merkel	SR1	63415-5698	73415-5698	83415-5698	93415-5698	93418-5698
	SR1 Basic	63415-562D	73415-562D	83415-562D	93415-562D	93418-562D
Remington	700 (Gewinde UNS 6-48)	63415-5612	73415-5612	83415-5612	93415-5612	93418-5612
	700 (Gewinde UNS 8-40)	63415-561N	73415-561N	83415-561N	93415-561N	93418-561N
	783	63415-5625	73415-5625	83415-5625	93415-5625	93418-5625
	7400 / 7600 / 750	63415-5613	73415-5613	83415-5613	93415-5613	93418-5613
	Seven	63415-5619	73415-5619	83415-5619	93415-5619	93418-5619
RWS-Rößler	Titan 3 / Titan 6 / Titan α	63415-5692	73415-5692	83415-5692	93415-5692	93418-5692
	Titan 16	63415-562G	73415-562G	83415-562G	93415-562G	93418-562G
Sabatti	Express	63415-561K	73415-561K	83415-561K	93415-561K	93418-561K
Sako	konisches Prisma / tapered dovetail	63415-5653	73415-5653	83415-5653	93415-5653	93418-5653
Sauer	80 / 90 / 92	63415-5615	73415-5615	83415-5615	93415-5615	93418-5615
	101	63415-562K	73415-562K	83415-562K	93415-562K	93418-562K
	200	63415-5616	73415-5616	83415-5616	93415-5616	93418-5616
	202	63415-5680	73415-5680	83415-5680	93415-5680	93418-5680
Savage	ebene Hülsenbrücke / flat Top	63415-5635	73415-5635	83415-5635	93415-5635	93418-5635
	gerundete Hülsenbrücke / rounded Top	63415-5693	73415-5693	83415-5693	93415-5693	93418-5693
Steyr-Mannlicher	Luxus (siehe Katalog auf Seite 61)					
	SBS-96	63415-5687	73415-5687	83415-5687	93415-5687	93418-5687
	SBS-96 Export/Pro Hunter/Classic/SM12/CLII	63415-5688	73415-5688	83415-5688	93415-5688	93418-5688
Swiss Arms	SHR-970 (Bohrungsabstand 21,9 mm)	63415-5640	73415-5640	83415-5640	93415-5640	93418-5640
Tikka	T3	63415-5681	73415-5681	83415-5681	93415-5681	93418-5681
Verney-Carron	Impact NT / Plus	63415-5647	73415-5647	83415-5647	93415-5647	93418-5647
Voere	LBW	63415-5655	73415-5655	83415-5655	93415-5655	93418-5655
Weatherby	Mark V / 300 / Vanguard	63415-5623	73415-5623	83415-5623	93415-5623	93418-5623
Winchester	70 short / long action	63415-5624	73415-5624	83415-5624	93415-5624	93418-5624
	70 Magnum (Baujahr nach 1964)	63415-5625	73415-5625	83415-5625	93415-5625	93418-5625
	70 WSM	63415-5611	73415-5611	83415-5611	93415-5611	93418-5611
	70 WSSM	63415-5669	73415-5669	83415-5669	93415-5669	93418-5669
	SXR Vulcan	63415-561J	73415-561J	83415-561J	93415-561J	93418-561J
Zastava	70	63415-5601	73415-5601	83415-5601	93415-5601	93418-5601

ERAMATIC®-SCHWENKMONTAGEN mit GK-Stahl-Klemmring ø 34 mm

ERAMATIC®-Swing mounts with steel rings ø 34 mm

Ausführungen / Models:

- **Mögliche Verlängerungen:** ohne bzw. mit 38 mm und 56 mm
Available extensions: none (short), 38 mm and 56 mm
- **Bauhöhe / Height:** 18,5 mm
- **Ringbreiten:** vorderer Magnum-Ring 22 mm, hinterer Ring 15 mm
Ring width: front Magnum ring 22 mm, rear ring 15 mm

Eramatic® Verschlussvarianten: Eramatic® lock-up systems:

- R6:** Verschlusskörper mit automatischer Verriegelungstechnik.
Für Prismenbasen und Schienenplatten mit 30°-Prisma.
Rotary locking system with automatic locking mechanism.
Fits all 30° rear dovetail bases and 30° rails.
- H7:** Verschlusskörper mit Entriegelungssicherung mittels Sperrklinke.
Für Prismenbasen und Schienenplatten mit 30°-Prisma.
Locking system with lever and integrated safety catch.
Fits all 30° rear dovetail bases and 30° rails.
- V8:** Verschlusskörper mit Doppelstangenverschluss.
Für Prismenbasen und Schienenplatten mit 20°-Prisma.
Locking system with self-locking clamp.
Fits all 20° rear bases and 20° rails.
- G9:** Verschlusskörper mit integriertem Kurvenspannsystem.
Für Prismenbasen und Schienenplatten mit 30°-Prisma und 15 mm Breite
sowie für 30° Laufschiene mit 12 mm und 14 mm Prismenbreite.
Rotary locking system.
Fits all 30° rear bases and 30° rails with a width of 12 mm, 14 mm or 15 mm.
- G9-Plus:** Verschlusskörper mit integriertem Kurvenspannsystem und geriffeltem Daumennocken.
Für Prismenbasen und Schienenplatten mit 30°-Prisma und 15 mm Breite.
Rotary locking system, specially shaped for easy handling.
Fits all 30° rear bases and 30° rails with a width of 15 mm.

Swing mounts with 22 mm large steel rings \varnothing 34 mm / Montages pivotants avec colliers \varnothing 34 mm, largeur 22 mm

- \varnothing 34 mm
- kurze Ausführung
- Bauhöhe: 18,5 mm
- Klemmringe aus Stahl
- GK-Vorderring 22 mm breit

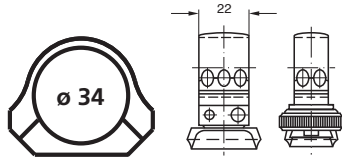

wahlweise mit folgenden ERAMATIC-Verschlüssen lieferbar:

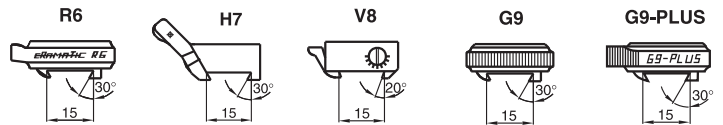

Anschütz	1780 / 1781	63422-002B	73422-002B	83422-002B	93422-002B	93428-002B
Antonio Zoli	1900	63422-0089	73422-0089	83422-0089	93422-0089	93428-0089
Benelli	ARGO	63422-0076	73422-0076	83422-0076	93422-0076	93428-0076
Beretta	689 gold sable / silver sable 2	63422-0099	73422-0099	83422-0099	93422-0099	93428-0099
Brüner CZ	Prisma 16,0 mm	63422-0061	73422-0061	83422-0061	93422-0061	93428-0061
	Prisma 19,5 mm	63422-0062	73422-0062	83422-0062	93422-0062	93428-0062
Chapuis	Express	63422-0029	73422-0029	83422-0029	93422-0029	93428-0029
Fair / Rizzini	Express	63422-0091	73422-0091	83422-0091	93422-0091	93428-0091
FN Browning	A-Bolt	63422-0020	73422-0020	83422-0020	93422-0020	93428-0020
	A-Bolt III	63422-002T	73422-002T	83422-002T	93422-002T	93428-002T
	A-Bolt WSSM	63422-001G	73422-001G	83422-001G	93422-001G	93428-001G
	BAR / BLR / CBL / Acera	63422-0003	73422-0003	83422-0003	93422-0003	93428-0003
	Eurobolt	63422-0078	73422-0078	83422-0078	93422-0078	93428-0078
	European	63422-0056	73422-0056	83422-0056	93422-0056	93428-0056
	Maral	63422-002J	73422-002J	83422-002J	93422-002J	93428-002J
	X-Bolt	63422-001P	73422-001P	83422-001P	93422-001P	93428-001P
Haenel	Jäger 10 (bis Serien-Nr. JX-000920)	63422-001W	73422-001W	83422-001W	93422-001W	93428-001W
	Jäger 10 (ab Serien-Nr. JX-000921)	63422-002C	73422-002C	83422-002C	93422-002C	93428-002C
	SLB 2000+	63422-002I	73422-002I	83422-002I	93422-002I	93428-002I
H&K	SLB 2000	63422-0008	73422-0008	83422-0008	93422-0008	93428-0008
Heym	SR 20	63422-0060	73422-0060	83422-0060	93422-0060	93428-0060
	SR 21	63422-0022	73422-0022	83422-0022	93422-0022	93428-0022
	SR 30	63422-0090	73422-0090	83422-0090	93422-0090	93428-0090
Howa	1500	63422-0059	73422-0059	83422-0059	93422-0059	93428-0059
Krico	600 / 700 / 900 / 902 Deluxe	63422-0006	73422-0006	83422-0006	93422-0006	93428-0006
Krieghoff	Semprio	63422-001C	73422-001C	83422-001C	93422-001C	93428-001C
Mauser	66	63422-0009	73422-0009	83422-0009	93422-0009	93428-0009
	M 94	63422-0094	73422-0094	83422-0094	93422-0094	93428-0094
	M 96	63422-0096	73422-0096	83422-0096	93422-0096	93428-0096
	M 96 (ab Serien-Nr. 12000) / M 97	63422-0097	73422-0097	83422-0097	93422-0097	93428-0097
	K 98 (und Nachbauten)	63422-0010	73422-0010	83422-0010	93422-0010	93428-0010
	M 12	63422-002L	73422-002L	83422-002L	93422-002L	93428-002L
Merkel	SR1	63422-0098	73422-0098	83422-0098	93422-0098	93428-0098
	SR1 Basic	63422-002D	73422-002D	83422-002D	93422-002D	93428-002D
Remington	700 (Gewinde UNS 6-48)	63422-0012	73422-0012	83422-0012	93422-0012	93428-0012
	700 (Gewinde UNS 8-40)	63422-001N	73422-001N	83422-001N	93422-001N	93428-001N
	783	63422-0025	73422-0025	83422-0025	93422-0025	93428-0025
	7400 / 7600 / 750	63422-0013	73422-0013	83422-0013	93422-0013	93428-0013
	Seven	63422-0019	73422-0019	83422-0019	93422-0019	93428-0019
RWS-Röbler	Titan 3 / Titan 6 / Titan α	63422-0092	73422-0092	83422-0092	93422-0092	93428-0092
	Titan 16	63422-002G	73422-002G	83422-002G	93422-002G	93428-002G
Sabatti	Express	63422-001K	73422-001K	83422-001K	93422-001K	93428-001K
Sako	konisches Prisma / tapered dovetail	63422-0053	73422-0053	83422-0053	93422-0053	93428-0053
Sauer	80 / 90 / 92	63422-0015	73422-0015	83422-0015	93422-0015	93428-0015
	101	63422-002K	73422-002K	83422-002K	93422-002K	93428-002K
	200	63422-0016	73422-0016	83422-0016	93422-0016	93428-0016
	202	63422-0080	73422-0080	83422-0080	93422-0080	93428-0080
Savage	ebene Hülsenbrücke / flat Top	63422-0035	73422-0035	83422-0035	93422-0035	93428-0035
	gerundete Hülsenbrücke / rounded Top	63422-0093	73422-0093	83422-0093	93422-0093	93428-0093
Steyr-Mannlicher	Luxus (siehe Katalog auf Seite 61)					
	SBS-96	63422-0087	73422-0087	83422-0087	93422-0087	93428-0087
	SBS-96 Export/Pro Hunter/Classic/SM12/CLII	63422-0088	73422-0088	83422-0088	93422-0088	93428-0088
Swiss Arms	SHR-970 (Bohrungsabstand 21,9 mm)	63422-0040	73422-0040	83422-0040	93422-0040	93428-0040
Tikka	T3	63422-0081	73422-0081	83422-0081	93422-0081	93428-0081
Verney-Carron	Impact NT / Plus	63422-0047	73422-0047	83422-0047	93422-0047	93428-0047
Voere	LBW	63422-0055	73422-0055	83422-0055	93422-0055	93428-0055
Weatherby	Mark V / 300 / Vanguard	63422-0023	73422-0023	83422-0023	93422-0023	93428-0023
Winchester	70 short / long action	63422-0024	73422-0024	83422-0024	93422-0024	93428-0024
	70 Magnum (Baujahr nach 1964)	63422-0025	73422-0025	83422-0025	93422-0025	93428-0025
	70 WSM	63422-0011	73422-0011	83422-0011	93422-0011	93428-0011
	70 WSSM	63422-0069	73422-0069	83422-0069	93422-0069	93428-0069
	SXR Vulcan	63422-001J	73422-001J	83422-001J	93422-001J	93428-001J
Zastava	70	63422-0001	73422-0001	83422-0001	93422-0001	93428-0001

Swing mounts with 22 mm large steel rings ø 34 mm / Montages pivotants avec colliers ø 34 mm, largeur 22 mm

- ø 34 mm
- Verlängerung 38 mm
- Bauhöhe: 18,5 mm
- Klemmringse aus Stahl
- GK-Vorderring 22 mm breit

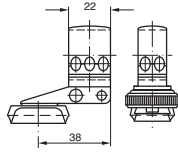

wahlweise mit folgenden ERAMATIC-Verschlüssen lieferbar:

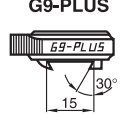
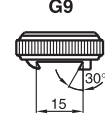
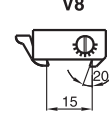
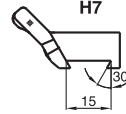
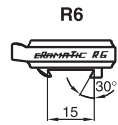

Anschütz	1780 / 1781	63422-382B	73422-382B	83422-382B	93422-382B	93428-382B
Antonio Zoli	1900	63422-3889	73422-3889	83422-3889	93422-3889	93428-3889
Benelli	ARGO	63422-3876	73422-3876	83422-3876	93422-3876	93428-3876
Beretta	689 gold sable / silver sable 2	63422-3899	73422-3899	83422-3899	93422-3899	93428-3899
Brünnner CZ	Prisma 16,0 mm	63422-3861	73422-3861	83422-3861	93422-3861	93428-3861
	Prisma 19,5 mm	63422-3862	73422-3862	83422-3862	93422-3862	93428-3862
Chapuis	Express	63422-3829	73422-3829	83422-3829	93422-3829	93428-3829
Fair / Rizzini	Express	63422-3891	73422-3891	83422-3891	93422-3891	93428-3891
FN Browning	A-Bolt	63422-3820	73422-3820	83422-3820	93422-3820	93428-3820
	A-Bolt III	63422-382T	73422-382T	83422-382T	93422-382T	93428-382T
	A-Bolt WSSM	63422-381G	73422-381G	83422-381G	93422-381G	93428-381G
	BAR / BLR / CBL / Acera	63422-3803	73422-3803	83422-3803	93422-3803	93428-3803
	Eurobolt	63422-3878	73422-3878	83422-3878	93422-3878	93428-3878
	European	63422-3856	73422-3856	83422-3856	93422-3856	93428-3856
	Maral	63422-382J	73422-382J	83422-382J	93422-382J	93428-382J
	X-Bolt	63422-381P	73422-381P	83422-381P	93422-381P	93428-381P
Haenel	Jäger 10 (bis Serien-Nr. JX-000920)	63422-381W	73422-381W	83422-381W	93422-381W	93428-381W
	Jäger 10 (ab Serien-Nr. JX-000921)	63422-382C	73422-382C	83422-382C	93422-382C	93428-382C
	SLB 2000+	63422-382I	73422-382I	83422-382I	93422-382I	93428-382I
H&K	SLB 2000	63422-3808	73422-3808	83422-3808	93422-3808	93428-3808
Heym	SR 20	63422-3860	73422-3860	83422-3860	93422-3860	93428-3860
	SR 21	63422-3822	73422-3822	83422-3822	93422-3822	93428-3822
	SR 30	63422-3890	73422-3890	83422-3890	93422-3890	93428-3890
Howa	1500	63422-3859	73422-3859	83422-3859	93422-3859	93428-3859
Krico	600 / 700 / 900 / 902 Deluxe	63422-3806	73422-3806	83422-3806	93422-3806	93428-3806
Krieghoff	Semprio	63422-381C	73422-381C	83422-381C	93422-381C	93428-381C
Mauser	66	63422-3809	73422-3809	83422-3809	93422-3809	93428-3809
	M 94	63422-3894	73422-3894	83422-3894	93422-3894	93428-3894
	M 96	63422-3896	73422-3896	83422-3896	93422-3896	93428-3896
	M 96 (ab Serien-Nr. 12000) / M 97	63422-3897	73422-3897	83422-3897	93422-3897	93428-3897
	K 98 (und Nachbauten)	63422-3810	73422-3810	83422-3810	93422-3810	93428-3810
	M 12	63422-382L	73422-382L	83422-382L	93422-382L	93428-382L
Merkel	SR1	63422-3898	73422-3898	83422-3898	93422-3898	93428-3898
	SR1 Basic	63422-382D	73422-382D	83422-382D	93422-382D	93428-382D
Remington	700 (Gewinde UNS 6-48)	63422-3812	73422-3812	83422-3812	93422-3812	93428-3812
	700 (Gewinde UNS 8-40)	63422-381N	73422-381N	83422-381N	93422-381N	93428-381N
	783	63422-3825	73422-3825	83422-3825	93422-3825	93428-3825
	7400 / 7600 / 750	63422-3813	73422-3813	83422-3813	93422-3813	93428-3813
	Seven	63422-3819	73422-3819	83422-3819	93422-3819	93428-3819
RWS-Rößler	Titan 3 / Titan 6 / Titan α	63422-3892	73422-3892	83422-3892	93422-3892	93428-3892
	Titan 16	63422-382G	73422-382G	83422-382G	93422-382G	93428-382G
Sabatti	Express	63422-381K	73422-381K	83422-381K	93422-381K	93428-381K
Sako	konisches Prisma / tapered dovetail	63422-3853	73422-3853	83422-3853	93422-3853	93428-3853
Sauer	80 / 90 / 92	63422-3815	73422-3815	83422-3815	93422-3815	93428-3815
	101	63422-382K	73422-382K	83422-382K	93422-382K	93428-382K
	200	63422-3816	73422-3816	83422-3816	93422-3816	93428-3816
	202	63422-3880	73422-3880	83422-3880	93422-3880	93428-3880
Savage	ebene Hülsenbrücke / flat Top	63422-3835	73422-3835	83422-3835	93422-3835	93428-3835
	gerundete Hülsenbrücke / rounded Top	63422-3893	73422-3893	83422-3893	93422-3893	93428-3893
Steyr-Mannlicher	Luxus (siehe Katalog auf Seite 61)					
	SBS-96	63422-3887	73422-3887	83422-3887	93422-3887	93428-3887
	SBS-96 Export/Pro Hunter/Classic/SM12/CLII	63422-3888	73422-3888	83422-3888	93422-3888	93428-3888
Swiss Arms	SHR-970 (Bohrungsabstand 21,9 mm)	63422-3840	73422-3840	83422-3840	93422-3840	93428-3840
Tikka	T3	63422-3881	73422-3881	83422-3881	93422-3881	93428-3881
Verney-Carron	Impact NT / Plus	63422-3847	73422-3847	83422-3847	93422-3847	93428-3847
Voere	LBW	63422-3855	73422-3855	83422-3855	93422-3855	93428-3855
Weatherby	Mark V / 300 / Vanguard	63422-3823	73422-3823	83422-3823	93422-3823	93428-3823
Winchester	70 short / long action	63422-3824	73422-3824	83422-3824	93422-3824	93428-3824
	70 Magnum (Baujahr nach 1964)	63422-3825	73422-3825	83422-3825	93422-3825	93428-3825
	70 WSM	63422-3811	73422-3811	83422-3811	93422-3811	93428-3811
	70 WSSM	63422-3869	73422-3869	83422-3869	93422-3869	93428-3869
	SXR Vulcan	63422-381J	73422-381J	83422-381J	93422-381J	93428-381J
Zastava	70	63422-3801	73422-3801	83422-3801	93422-3801	93428-3801

Swing mounts with 22 mm large steel rings ø 34 mm / Montages pivotants avec colliers ø 34 mm, largeur 22 mm

- ø 34 mm
- Verlängerung 56 mm
- Bauhöhe: 18,5 mm
- Klemmringse aus Stahl
- GK-Vorderring 22 mm breit

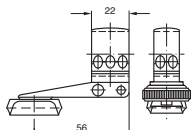

wahlweise mit folgenden ERAMATIC-Verschlüssen lieferbar:

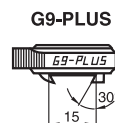
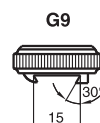
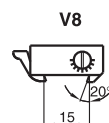
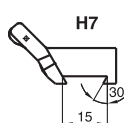
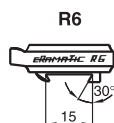

Anschütz	1780 / 1781	63422-562B	73422-562B	83422-562B	93422-562B	93428-562B
Antonio Zoli	1900	63422-5689	73422-5689	83422-5689	93422-5689	93428-5689
Benelli	ARGO	63422-5676	73422-5676	83422-5676	93422-5676	93428-5676
Beretta	689 gold sable / silver sable 2	63422-5699	73422-5699	83422-5699	93422-5699	93428-5699
Brünnner CZ	Prisma 16,0 mm	63422-5661	73422-5661	83422-5661	93422-5661	93428-5661
	Prisma 19,5 mm	63422-5662	73422-5662	83422-5662	93422-5662	93428-5662
Chapuis	Express	63422-5629	73422-5629	83422-5629	93422-5629	93428-5629
Fair / Rizzini	Express	63422-5691	73422-5691	83422-5691	93422-5691	93428-5691
FN Browning	A-Bolt	63422-5620	73422-5620	83422-5620	93422-5620	93428-5620
	A-Bolt III	63422-562T	73422-562T	83422-562T	93422-562T	93428-562T
	A-Bolt WSSM	63422-561G	73422-561G	83422-561G	93422-561G	93428-561G
	BAR / BLR / CBL / Acera	63422-5603	73422-5603	83422-5603	93422-5603	93428-5603
	Eurobolt	63422-5678	73422-5678	83422-5678	93422-5678	93428-5678
	European	63422-5656	73422-5656	83422-5656	93422-5656	93428-5656
	Maral	63422-562J	73422-562J	83422-562J	93422-562J	93428-562J
	X-Bolt	63422-561P	73422-561P	83422-561P	93422-561P	93428-561P
Haenel	Jäger 10 (bis Serien-Nr. JX-000920)	63422-561W	73422-561W	83422-561W	93422-561W	93428-561W
	Jäger 10 (ab Serien-Nr. JX-000921)	63422-562C	73422-562C	83422-562C	93422-562C	93428-562C
	SLB 2000+	63422-562I	73422-562I	83422-562I	93422-562I	93428-562I
H&K	SLB 2000	63422-5608	73422-5608	83422-5608	93422-5608	93428-5608
Heym	SR 20	63422-5660	73422-5660	83422-5660	93422-5660	93428-5660
	SR 21	63422-5622	73422-5622	83422-5622	93422-5622	93428-5622
	SR 30	63422-5690	73422-5690	83422-5690	93422-5690	93428-5690
Howa	1500	63422-5659	73422-5659	83422-5659	93422-5659	93428-5659
Krico	600 / 700 / 900 / 902 Deluxe	63422-5606	73422-5606	83422-5606	93422-5606	93428-5606
Krieghoff	Semprio	63422-561C	73422-561C	83422-561C	93422-561C	93428-561C
Mauser	66	63422-5609	73422-5609	83422-5609	93422-5609	93428-5609
	M 94	63422-5694	73422-5694	83422-5694	93422-5694	93428-5694
	M 96	63422-5696	73422-5696	83422-5696	93422-5696	93428-5696
	M 96 (ab Serien-Nr. 12000) / M 97	63422-5697	73422-5697	83422-5697	93422-5697	93428-5697
	K 98 (und Nachbauten)	63422-5610	73422-5610	83422-5610	93422-5610	93428-5610
	M 12	63422-562L	73422-562L	83422-562L	93422-562L	93428-562L
Merkel	SR1	63422-5698	73422-5698	83422-5698	93422-5698	93428-5698
	SR1 Basic	63422-562D	73422-562D	83422-562D	93422-562D	93428-562D
Remington	700 (Gewinde UNS 6-48)	63422-5612	73422-5612	83422-5612	93422-5612	93428-5612
	700 (Gewinde UNS 8-40)	63422-561N	73422-561N	83422-561N	93422-561N	93428-561N
	783	63422-5625	73422-5625	83422-5625	93422-5625	93428-5625
	7400 / 7600 / 750	63422-5613	73422-5613	83422-5613	93422-5613	93428-5613
	Seven	63422-5619	73422-5619	83422-5619	93422-5619	93428-5619
RWS-Röbber	Titan 3 / Titan 6 / Titan α	63422-5692	73422-5692	83422-5692	93422-5692	93428-5692
	Titan 16	63422-562G	73422-562G	83422-562G	93422-562G	93428-562G
Sabatti	Express	63422-561K	73422-561K	83422-561K	93422-561K	93428-561K
Sako	konisches Prisma / tapered dovetail	63422-5653	73422-5653	83422-5653	93422-5653	93428-5653
Sauer	80 / 90 / 92	63422-5615	73422-5615	83422-5615	93422-5615	93428-5615
	101	63422-562K	73422-562K	83422-562K	93422-562K	93428-562K
	200	63422-5616	73422-5616	83422-5616	93422-5616	93428-5616
	202	63422-5680	73422-5680	83422-5680	93422-5680	93428-5680
Savage	ebene Hülsenbrücke / flat Top	63422-5635	73422-5635	83422-5635	93422-5635	93428-5635
	gerundete Hülsenbrücke / rounded Top	63422-5693	73422-5693	83422-5693	93422-5693	93428-5693
Steyr-Mannlicher	Luxus (siehe Katalog auf Seite 61)					
	SBS-96	63422-5687	73422-5687	83422-5687	93422-5687	93428-5687
	SBS-96 Export/Pro Hunter/Classic/SM12/CLII	63422-5688	73422-5688	83422-5688	93422-5688	93428-5688
Swiss Arms	SHR-970 (Bohrungsabstand 21,9 mm)	63422-5640	73422-5640	83422-5640	93422-5640	93428-5640
Tikka	T3	63422-5681	73422-5681	83422-5681	93422-5681	93428-5681
Verney-Carron	Impact NT / Plus	63422-5647	73422-5647	83422-5647	93422-5647	93428-5647
Voere	LBW	63422-5655	73422-5655	83422-5655	93422-5655	93428-5655
Weatherby	Mark V / 300 / Vanguard	63422-5623	73422-5623	83422-5623	93422-5623	93428-5623
Winchester	70 short / long action	63422-5624	73422-5624	83422-5624	93422-5624	93428-5624
	70 Magnum (Baujahr nach 1964)	63422-5625	73422-5625	83422-5625	93422-5625	93428-5625
	70 WSM	63422-5611	73422-5611	83422-5611	93422-5611	93428-5611
	70 WSSM	63422-5669	73422-5669	83422-5669	93422-5669	93428-5669
	SXR Vulcan	63422-561J	73422-561J	83422-561J	93422-561J	93428-561J
Zastava	70	63422-5601	73422-5601	83422-5601	93422-5601	93428-5601

ERAMATIC®-SCHWENKMONTAGEN mit Stahl-Klemmringsen ø 36 mm

ERAMATIC®-Swing mounts with steel rings ø 36 mm

Ausführungen / Models:

- **Mögliche Verlängerungen:** ohne bzw. mit 26 mm, 31 mm, 44 mm und 56 mm
Available extensions: none (short), 26 mm, 31 mm, 44 mm and 56 mm
- **Bauhöhe / Height:** 18,5 mm
- **Ringbreite / Ring width:** 15,0 mm

Eramatic® Verschlussvarianten: Eramatic® lock-up systems:

- R6:** Verschlusskörper mit automatischer Verriegelungstechnik.
Für Prismenbasen und Schienenplatten mit 30°-Prisma.
Rotary locking system with automatic locking mechanism.
Fits all 30° rear dovetail bases and 30° rails.
- H7:** Verschlusskörper mit Entriegelungssicherung mittels Sperrklinke.
Für Prismenbasen und Schienenplatten mit 30°-Prisma.
Locking system with lever and integrated safety catch.
Fits all 30° rear dovetail bases and 30° rails.
- V8:** Verschlusskörper mit Doppelstangenverschluss.
Für Prismenbasen und Schienenplatten mit 20°-Prisma.
Locking system with self-locking clamp.
Fits all 20° rear bases and 20° rails.
- G9:** Verschlusskörper mit integriertem Kurvenspannsystem.
Für Prismenbasen und Schienenplatten mit 30°-Prisma und 15 mm Breite
sowie für 30° Laufschiene mit 12 mm und 14 mm Prismenbreite.
Rotary locking system.
Fits all 30° rear bases and 30° rails with a width of 12 mm, 14 mm or 15 mm.
- G9-Plus:** Verschlusskörper mit integriertem Kurvenspannsystem und geriffeltem Daumennocken.
Für Prismenbasen und Schienenplatten mit 30°-Prisma und 15 mm Breite.
Rotary locking system, specially shaped for easy handling.
Fits all 30° rear bases and 30° rails with a width of 15 mm.

Swing mounts with steel rings ø 36 mm / Montages pivotants avec colliers ø 36 mm

- ø 36 mm
- kurze Ausführung
- Bauhöhe: 18,5 mm
- Klemmringe aus Stahl
- Ringbreite 15 mm

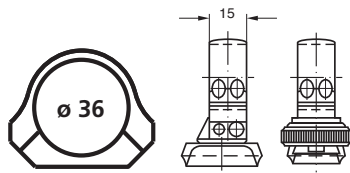

wahlweise mit folgenden ERAMATIC-Verschlüssen lieferbar:

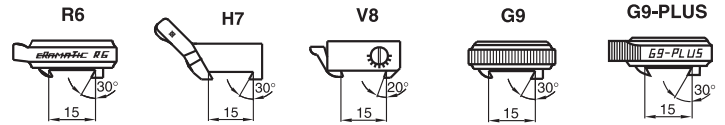

Anschütz	1780 / 1781	63615-002B	73615-002B	83615-002B	93615-002B	93618-002B
Antonio Zoli	1900	63615-0089	73615-0089	83615-0089	93615-0089	93618-0089
Benelli	ARGO	63615-0076	73615-0076	83615-0076	93615-0076	93618-0076
Beretta	689 gold sable / silver sable 2	63615-0099	73615-0099	83615-0099	93615-0099	93618-0099
Brünnner CZ	Prisma 16,0 mm	63615-0061	73615-0061	83615-0061	93615-0061	93618-0061
	Prisma 19,5 mm	63615-0062	73615-0062	83615-0062	93615-0062	93618-0062
Chapuis	Express	63615-0029	73615-0029	83615-0029	93615-0029	93618-0029
Fair / Rizzini	Express	63615-0091	73615-0091	83615-0091	93615-0091	93618-0091
FN Browning	A-Bolt	63615-0020	73615-0020	83615-0020	93615-0020	93618-0020
	A-Bolt III	63615-002T	73615-002T	83615-002T	93615-002T	93618-002T
	A-Bolt WSSM	63615-001G	73615-001G	83615-001G	93615-001G	93618-001G
	BAR / BLR / CBL / Acera	63615-0003	73615-0003	83615-0003	93615-0003	93618-0003
	Eurobolt	63615-0078	73615-0078	83615-0078	93615-0078	93618-0078
	European	63615-0056	73615-0056	83615-0056	93615-0056	93618-0056
	Maral	63615-002J	73615-002J	83615-002J	93615-002J	93618-002J
	X-Bolt	63615-001P	73615-001P	83615-001P	93615-001P	93618-001P
Haenel	Jäger 10 (bis Serien-Nr. JX-000920)	63615-001W	73615-001W	83615-001W	93615-001W	93618-001W
	Jäger 10 (ab Serien-Nr. JX-000921)	63615-002C	73615-002C	83615-002C	93615-002C	93618-002C
	SLB 2000+	63615-002I	73615-002I	83615-002I	93615-002I	93618-002I
H&K	SLB 2000	63615-0008	73615-0008	83615-0008	93615-0008	93618-0008
Heym	SR 20	63615-0060	73615-0060	83615-0060	93615-0060	93618-0060
	SR 21	63615-0022	73615-0022	83615-0022	93615-0022	93618-0022
	SR 30	63615-0090	73615-0090	83615-0090	93615-0090	93618-0090
Howa	1500	63615-0059	73615-0059	83615-0059	93615-0059	93618-0059
Krico	600 / 700 / 900 / 902 Deluxe	63615-0006	73615-0006	83615-0006	93615-0006	93618-0006
Krieghoff	Semprio	63615-001C	73615-001C	83615-001C	93615-001C	93618-001C
Mauser	66	63615-0009	73615-0009	83615-0009	93615-0009	93618-0009
	M 94	63615-0094	73615-0094	83615-0094	93615-0094	93618-0094
	M 96	63615-0096	73615-0096	83615-0096	93615-0096	93618-0096
	M 96 (ab Serien-Nr. 12000) / M 97	63615-0097	73615-0097	83615-0097	93615-0097	93618-0097
	K 98 (und Nachbauten)	63615-0010	73615-0010	83615-0010	93615-0010	93618-0010
	M 12	63615-002L	73615-002L	83615-002L	93615-002L	93618-002L
Merkel	SR1	63615-0098	73615-0098	83615-0098	93615-0098	93618-0098
	SR1 Basic	63615-002D	73615-002D	83615-002D	93615-002D	93618-002D
Remington	700 (Gewinde UNS 6-48)	63615-0012	73615-0012	83615-0012	93615-0012	93618-0012
	700 (Gewinde UNS 8-40)	63615-001N	73615-001N	83615-001N	93615-001N	93618-001N
	783	63615-0025	73615-0025	83615-0025	93615-0025	93618-0025
	7400 / 7600 / 750	63615-0013	73615-0013	83615-0013	93615-0013	93618-0013
	Seven	63615-0019	73615-0019	83615-0019	93615-0019	93618-0019
RWS-Röbler	Titan 3 / Titan 6 / Titan α	63615-0092	73615-0092	83615-0092	93615-0092	93618-0092
	Titan 16	63615-002G	73615-002G	83615-002G	93615-002G	93618-002G
Sabatti	Express	63615-001K	73615-001K	83615-001K	93615-001K	93618-001K
Sako	konisches Prisma / tapered dovetail	63615-0053	73615-0053	83615-0053	93615-0053	93618-0053
Sauer	80 / 90 / 92	63615-0015	73615-0015	83615-0015	93615-0015	93618-0015
	101	63615-002K	73615-002K	83615-002K	93615-002K	93618-002K
	200	63615-0016	73615-0016	83615-0016	93615-0016	93618-0016
	202	63615-0080	73615-0080	83615-0080	93615-0080	93618-0080
Savage	ebene Hülsenbrücke / flat Top	63615-0035	73615-0035	83615-0035	93615-0035	93618-0035
	gerundete Hülsenbrücke / rounded Top	63615-0093	73615-0093	83615-0093	93615-0093	93618-0093
Steyr-Mannlicher	Luxus (siehe Katalog auf Seite 61)					
	SBS-96	63615-0087	73615-0087	83615-0087	93615-0087	93618-0087
	SBS-96 Export/Pro Hunter/Classic/SM12/CLII	63615-0088	73615-0088	83615-0088	93615-0088	93618-0088
Swiss Arms	SHR-970 (Bohrungsabstand 21,9 mm)	63615-0040	73615-0040	83615-0040	93615-0040	93618-0040
Tikka	T3	63615-0081	73615-0081	83615-0081	93615-0081	93618-0081
Verney-Carron	Impact NT / Plus	63615-0047	73615-0047	83615-0047	93615-0047	93618-0047
Voere	LBW	63615-0055	73615-0055	83615-0055	93615-0055	93618-0055
Weatherby	Mark V / 300 / Vanguard	63615-0023	73615-0023	83615-0023	93615-0023	93618-0023
Winchester	70 short / long action	63615-0024	73615-0024	83615-0024	93615-0024	93618-0024
	70 Magnum (Baujahr nach 1964)	63615-0025	73615-0025	83615-0025	93615-0025	93618-0025
	70 WSM	63615-0011	73615-0011	83615-0011	93615-0011	93618-0011
	70 WSSM	63615-0069	73615-0069	83615-0069	93615-0069	93618-0069
	SXR Vulcan	63615-001J	73615-001J	83615-001J	93615-001J	93618-001J
Zastava	70	63615-0001	73615-0001	83615-0001	93615-0001	93618-0001

Swing mounts with steel rings ø 36 mm / Montages pivotants avec colliers ø 36 mm

- ø 36 mm
- Verlängerung 26 mm
- Bauhöhe: 18,5 mm
- Klemmringse aus Stahl
- Ringbreite 15 mm

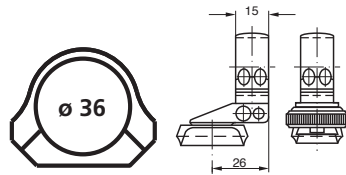

wahlweise mit folgenden ERAMATIC-Verschlüssen lieferbar:

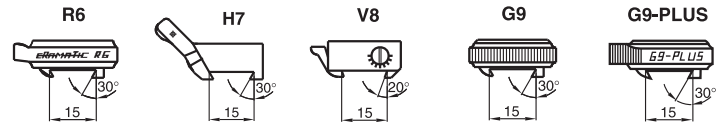

Anschütz	1780 / 1781	63615-262B	73615-262B	83615-262B	93615-262B	93618-262B
Antonio Zoli	1900	63615-2689	73615-2689	83615-2689	93615-2689	93618-2689
Benelli	ARGO	63615-2676	73615-2676	83615-2676	93615-2676	93618-2676
Beretta	689 gold sable / silver sable 2	63615-2699	73615-2699	83615-2699	93615-2699	93618-2699
Brünnner CZ	Prisma 16,0 mm	63615-2661	73615-2661	83615-2661	93615-2661	93618-2661
	Prisma 19,5 mm	63615-2662	73615-2662	83615-2662	93615-2662	93618-2662
Chapuis	Express	63615-2629	73615-2629	83615-2629	93615-2629	93618-2629
Fair / Rizzini	Express	63615-2691	73615-2691	83615-2691	93615-2691	93618-2691
FN Browning	A-Bolt	63615-2620	73615-2620	83615-2620	93615-2620	93618-2620
	A-Bolt III	63615-262T	73615-262T	83615-262T	93615-262T	93618-262T
	A-Bolt WSSM	63615-261G	73615-261G	83615-261G	93615-261G	93618-261G
	BAR / BLR / CBL / Acera	63615-2603	73615-2603	83615-2603	93615-2603	93618-2603
	Eurobolt	63615-2678	73615-2678	83615-2678	93615-2678	93618-2678
	European	63615-2656	73615-2656	83615-2656	93615-2656	93618-2656
	Maral	63615-262J	73615-262J	83615-262J	93615-262J	93618-262J
	X-Bolt	63615-261P	73615-261P	83615-261P	93615-261P	93618-261P
Haenel	Jäger 10 (bis Serien-Nr. JX-000920)	63615-261W	73615-261W	83615-261W	93615-261W	93618-261W
	Jäger 10 (ab Serien-Nr. JX-000921)	63615-262C	73615-262C	83615-262C	93615-262C	93618-262C
	SLB 2000+	63615-262I	73615-262I	83615-262I	93615-262I	93618-262I
H&K	SLB 2000	63615-2608	73615-2608	83615-2608	93615-2608	93618-2608
Heym	SR 20	63615-2660	73615-2660	83615-2660	93615-2660	93618-2660
	SR 21	63615-2622	73615-2622	83615-2622	93615-2622	93618-2622
	SR 30	63615-2690	73615-2690	83615-2690	93615-2690	93618-2690
Howa	1500	63615-2659	73615-2659	83615-2659	93615-2659	93618-2659
Krico	600 / 700 / 900 / 902 Deluxe	63615-2606	73615-2606	83615-2606	93615-2606	93618-2606
Krieghoff	Semprio	63615-261C	73615-261C	83615-261C	93615-261C	93618-261C
Mauser	66	63615-2609	73615-2609	83615-2609	93615-2609	93618-2609
	M 94	63615-2694	73615-2694	83615-2694	93615-2694	93618-2694
	M 96	63615-2696	73615-2696	83615-2696	93615-2696	93618-2696
	M 96 (ab Serien-Nr. 12000) / M 97	63615-2697	73615-2697	83615-2697	93615-2697	93618-2697
	K 98 (und Nachbauten)	63615-2610	73615-2610	83615-2610	93615-2610	93618-2610
	M 12	63615-262L	73615-262L	83615-262L	93615-262L	93618-262L
Merkel	SR1	63615-2698	73615-2698	83615-2698	93615-2698	93618-2698
	SR1 Basic	63615-262D	73615-262D	83615-262D	93615-262D	93618-262D
Remington	700 (Gewinde UNS 6-48)	63615-2612	73615-2612	83615-2612	93615-2612	93618-2612
	700 (Gewinde UNS 8-40)	63615-261N	73615-261N	83615-261N	93615-261N	93618-261N
	783	63615-2625	73615-2625	83615-2625	93615-2625	93618-2625
	7400 / 7600 / 750	63615-2613	73615-2613	83615-2613	93615-2613	93618-2613
	Seven	63615-2619	73615-2619	83615-2619	93615-2619	93618-2619
RWS-Rößler	Titan 3 / Titan 6 / Titan α	63615-2692	73615-2692	83615-2692	93615-2692	93618-2692
	Titan 16	63615-262G	73615-262G	83615-262G	93615-262G	93618-262G
Sabatti	Express	63615-261K	73615-261K	83615-261K	93615-261K	93618-261K
Sako	konisches Prisma / tapered dovetail	63615-2653	73615-2653	83615-2653	93615-2653	93618-2653
Sauer	80 / 90 / 92	63615-2615	73615-2615	83615-2615	93615-2615	93618-2615
	101	63615-262K	73615-262K	83615-262K	93615-262K	93618-262K
	200	63615-2616	73615-2616	83615-2616	93615-2616	93618-2616
	202	63615-2680	73615-2680	83615-2680	93615-2680	93618-2680
Savage	ebene Hülsenbrücke / flat Top	63615-2635	73615-2635	83615-2635	93615-2635	93618-2635
	gerundete Hülsenbrücke / rounded Top	63615-2693	73615-2693	83615-2693	93615-2693	93618-2693
Steyr-Mannlicher	Luxus (siehe Katalog auf Seite 61)					
	SBS-96	63615-2687	73615-2687	83615-2687	93615-2687	93618-2687
	SBS-96 Export/Pro Hunter/Classic/SM12/CLII	63615-2688	73615-2688	83615-2688	93615-2688	93618-2688
Swiss Arms	SHR-970 (Bohrungsabstand 21,9 mm)	63615-2640	73615-2640	83615-2640	93615-2640	93618-2640
Tikka	T3	63615-2681	73615-2681	83615-2681	93615-2681	93618-2681
Verney-Carron	Impact NT / Plus	63615-2647	73615-2647	83615-2647	93615-2647	93618-2647
Voere	LBW	63615-2655	73615-2655	83615-2655	93615-2655	93618-2655
Weatherby	Mark V / 300 / Vanguard	63615-2623	73615-2623	83615-2623	93615-2623	93618-2623
Winchester	70 short / long action	63615-2624	73615-2624	83615-2624	93615-2624	93618-2624
	70 Magnum (Baujahr nach 1964)	63615-2625	73615-2625	83615-2625	93615-2625	93618-2625
	70 WSM	63615-2611	73615-2611	83615-2611	93615-2611	93618-2611
	70 WSSM	63615-2669	73615-2669	83615-2669	93615-2669	93618-2669
	SXR Vulcan	63615-261J	73615-261J	83615-261J	93615-261J	93618-261J
Zastava	70	63615-2601	73615-2601	83615-2601	93615-2601	93618-2601

Swing mounts with steel rings ø 36 mm / Montages pivotants avec colliers ø 36 mm

- ø 36 mm
- Verlängerung 31 mm
- Bauhöhe: 18,5 mm
- Klemmringse aus Stahl
- Ringbreite 15 mm

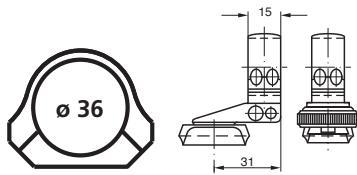

wahlweise mit folgenden ERAMATIC-Verschlüssen lieferbar:

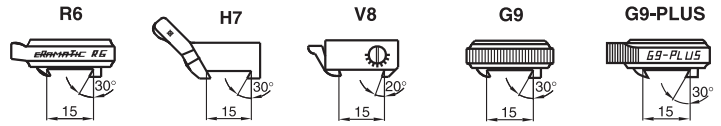

Anschütz	1780 / 1781	63615-312B	73615-312B	83615-312B	93615-312B	93618-312B
Antonio Zoli	1900	63615-3189	73615-3189	83615-3189	93615-3189	93618-3189
Benelli	ARGO	63615-3176	73615-3176	83615-3176	93615-3176	93618-3176
Beretta	689 gold sable / silver sable 2	63615-3199	73615-3199	83615-3199	93615-3199	93618-3199
Brünnner CZ	Prisma 16,0 mm	63615-3161	73615-3161	83615-3161	93615-3161	93618-3161
	Prisma 19,5 mm	63615-3162	73615-3162	83615-3162	93615-3162	93618-3162
Chapuis	Express	63615-3129	73615-3129	83615-3129	93615-3129	93618-3129
Fair / Rizzini	Express	63615-3191	73615-3191	83615-3191	93615-3191	93618-3191
FN Browning	A-Bolt	63615-3120	73615-3120	83615-3120	93615-3120	93618-3120
	A-Bolt III	63615-312T	73615-312T	83615-312T	93615-312T	93618-312T
	A-Bolt WSSM	63615-311G	73615-311G	83615-311G	93615-311G	93618-311G
	BAR / BLR / CBL / Acera	63615-3103	73615-3103	83615-3103	93615-3103	93618-3103
	Eurobolt	63615-3178	73615-3178	83615-3178	93615-3178	93618-3178
	European	63615-3156	73615-3156	83615-3156	93615-3156	93618-3156
	Maral	63615-312J	73615-312J	83615-312J	93615-312J	93618-312J
	X-Bolt	63615-311P	73615-311P	83615-311P	93615-311P	93618-311P
Haenel	Jäger 10 (bis Serien-Nr. JX-000920)	63615-311W	73615-311W	83615-311W	93615-311W	93618-311W
	Jäger 10 (ab Serien-Nr. JX-000921)	63615-312C	73615-312C	83615-312C	93615-312C	93618-312C
	SLB 2000+	63615-312I	73615-312I	83615-312I	93615-312I	93618-312I
H&K	SLB 2000	63615-3108	73615-3108	83615-3108	93615-3108	93618-3108
Heym	SR 20	63615-3160	73615-3160	83615-3160	93615-3160	93618-3160
	SR 21	63615-3122	73615-3122	83615-3122	93615-3122	93618-3122
	SR 30	63615-3190	73615-3190	83615-3190	93615-3190	93618-3190
Howa	1500	63615-3159	73615-3159	83615-3159	93615-3159	93618-3159
Krico	600 / 700 / 900 / 902 Deluxe	63615-3106	73615-3106	83615-3106	93615-3106	93618-3106
Krieghoff	Semprio	63615-311C	73615-311C	83615-311C	93615-311C	93618-311C
Mauser	66	63615-3109	73615-3109	83615-3109	93615-3109	93618-3109
	M 94	63615-3194	73615-3194	83615-3194	93615-3194	93618-3194
	M 96	63615-3196	73615-3196	83615-3196	93615-3196	93618-3196
	M 96 (ab Serien-Nr. 12000) / M 97	63615-3197	73615-3197	83615-3197	93615-3197	93618-3197
	K 98 (und Nachbauten)	63615-3110	73615-3110	83615-3110	93615-3110	93618-3110
	M 12	63615-312L	73615-312L	83615-312L	93615-312L	93618-312L
Merkel	SR1	63615-3198	73615-3198	83615-3198	93615-3198	93618-3198
	SR1 Basic	63615-312D	73615-312D	83615-312D	93615-312D	93618-312D
Remington	700 (Gewinde UNS 6-48)	63615-3112	73615-3112	83615-3112	93615-3112	93618-3112
	700 (Gewinde UNS 8-40)	63615-311N	73615-311N	83615-311N	93615-311N	93618-311N
	783	63615-3125	73615-3125	83615-3125	93615-3125	93618-3125
	7400 / 7600 / 750	63615-3113	73615-3113	83615-3113	93615-3113	93618-3113
	Seven	63615-3119	73615-3119	83615-3119	93615-3119	93618-3119
RWS-Rößler	Titan 3 / Titan 6 / Titan α	63615-3192	73615-3192	83615-3192	93615-3192	93618-3192
	Titan 16	63615-312G	73615-312G	83615-312G	93615-312G	93618-312G
Sabatti	Express	63615-311K	73615-311K	83615-311K	93615-311K	93618-311K
Sako	konisches Prisma / tapered dovetail	63615-3153	73615-3153	83615-3153	93615-3153	93618-3153
Sauer	80 / 90 / 92	63615-3115	73615-3115	83615-3115	93615-3115	93618-3115
	101	63615-312K	73615-312K	83615-312K	93615-312K	93618-312K
	200	63615-3116	73615-3116	83615-3116	93615-3116	93618-3116
	202	63615-3180	73615-3180	83615-3180	93615-3180	93618-3180
Savage	ebene Hülsenbrücke / flat Top	63615-3135	73615-3135	83615-3135	93615-3135	93618-3135
	gerundete Hülsenbrücke / rounded Top	63615-3193	73615-3193	83615-3193	93615-3193	93618-3193
Steyr-Mannlicher	Luxus (siehe Katalog auf Seite 61)					
	SBS-96	63615-3187	73615-3187	83615-3187	93615-3187	93618-3187
	SBS-96 Export/Pro Hunter/Classic/SM12/CLII	63615-3188	73615-3188	83615-3188	93615-3188	93618-3188
Swiss Arms	SHR-970 (Bohrungsabstand 21,9 mm)	63615-3140	73615-3140	83615-3140	93615-3140	93618-3140
Tikka	T3	63615-3181	73615-3181	83615-3181	93615-3181	93618-3181
Verney-Carron	Impact NT / Plus	63615-3147	73615-3147	83615-3147	93615-3147	93618-3147
Voere	LBW	63615-3155	73615-3155	83615-3155	93615-3155	93618-3155
Weatherby	Mark V / 300 / Vanguard	63615-3123	73615-3123	83615-3123	93615-3123	93618-3123
Winchester	70 short / long action	63615-3124	73615-3124	83615-3124	93615-3124	93618-3124
	70 Magnum (Baujahr nach 1964)	63615-3125	73615-3125	83615-3125	93615-3125	93618-3125
	70 WSM	63615-3111	73615-3111	83615-3111	93615-3111	93618-3111
	70 WSSM	63615-3169	73615-3169	83615-3169	93615-3169	93618-3169
	SXR Vulcan	63615-311J	73615-311J	83615-311J	93615-311J	93618-311J
Zastava	70	63615-3101	73615-3101	83615-3101	93615-3101	93618-3101

Swing mounts with steel rings \varnothing 36 mm / Montages pivotants avec colliers \varnothing 36 mm

- \varnothing 36 mm
- Verlängerung 44 mm
- Bauhöhe: 18,5 mm
- Klemmringe aus Stahl
- Ringbreite 15 mm

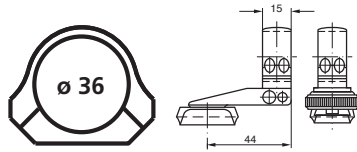

wahlweise mit folgenden ERAMATIC-Verschlüssen lieferbar:

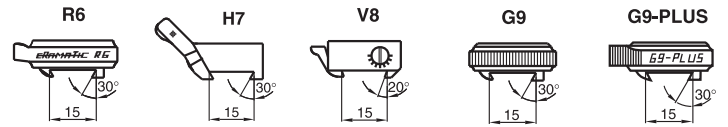

Anschütz	1780 / 1781	63615-442B	73615-442B	83615-442B	93615-442B	93618-442B
Antonio Zoli	1900	63615-4489	73615-4489	83615-4489	93615-4489	93618-4489
Benelli	ARGO	63615-4476	73615-4476	83615-4476	93615-4476	93618-4476
Beretta	689 gold sable / silver sable 2	63615-4499	73615-4499	83615-4499	93615-4499	93618-4499
Brügger CZ	Prisma 16,0 mm	63615-4461	73615-4461	83615-4461	93615-4461	93618-4461
	Prisma 19,5 mm	63615-4462	73615-4462	83615-4462	93615-4462	93618-4462
Chapuis	Express	63615-4429	73615-4429	83615-4429	93615-4429	93618-4429
Fair / Rizzini	Express	63615-4491	73615-4491	83615-4491	93615-4491	93618-4491
FN Browning	A-Bolt	63615-4420	73615-4420	83615-4420	93615-4420	93618-4420
	A-Bolt III	63615-442T	73615-442T	83615-442T	93615-442T	93618-442T
	A-Bolt WSSM	63615-441G	73615-441G	83615-441G	93615-441G	93618-441G
	BAR / BLR / CBL / Acera	63615-4403	73615-4403	83615-4403	93615-4403	93618-4403
	Eurobolt	63615-4478	73615-4478	83615-4478	93615-4478	93618-4478
	European	63615-4456	73615-4456	83615-4456	93615-4456	93618-4456
	Maral	63615-442J	73615-442J	83615-442J	93615-442J	93618-442J
	X-Bolt	63615-441P	73615-441P	83615-441P	93615-441P	93618-441P
Haenel	Jäger 10 (bis Serien-Nr. JX-000920)	63615-441W	73615-441W	83615-441W	93615-441W	93618-441W
	Jäger 10 (ab Serien-Nr. JX-000921)	63615-442C	73615-442C	83615-442C	93615-442C	93618-442C
	SLB 2000+	63615-442I	73615-442I	83615-442I	93615-442I	93618-442I
H&K	SLB 2000	63615-4408	73615-4408	83615-4408	93615-4408	93618-4408
Heym	SR 20	63615-4460	73615-4460	83615-4460	93615-4460	93618-4460
	SR 21	63615-4422	73615-4422	83615-4422	93615-4422	93618-4422
	SR 30	63615-4490	73615-4490	83615-4490	93615-4490	93618-4490
Howa	1500	63615-4459	73615-4459	83615-4459	93615-4459	93618-4459
Krico	600 / 700 / 900 / 902 Deluxe	63615-4406	73615-4406	83615-4406	93615-4406	93618-4406
Krieghoff	Semprio	63615-441C	73615-441C	83615-441C	93615-441C	93618-441C
Mauser	66	63615-4409	73615-4409	83615-4409	93615-4409	93618-4409
	M 94	63615-4494	73615-4494	83615-4494	93615-4494	93618-4494
	M 96	63615-4496	73615-4496	83615-4496	93615-4496	93618-4496
	M 96 (ab Serien-Nr. 12000) / M 97	63615-4497	73615-4497	83615-4497	93615-4497	93618-4497
	K 98 (und Nachbauten)	63615-4410	73615-4410	83615-4410	93615-4410	93618-4410
	M 12	63615-442L	73615-442L	83615-442L	93615-442L	93618-442L
Merkel	SR1	63615-4498	73615-4498	83615-4498	93615-4498	93618-4498
	SR1 Basic	63615-442D	73615-442D	83615-442D	93615-442D	93618-442D
Remington	700 (Gewinde UNS 6-48)	63615-4412	73615-4412	83615-4412	93615-4412	93618-4412
	700 (Gewinde UNS 8-40)	63615-441N	73615-441N	83615-441N	93615-441N	93618-441N
	783	63615-4425	73615-4425	83615-4425	93615-4425	93618-4425
	7400 / 7600 / 750	63615-4413	73615-4413	83615-4413	93615-4413	93618-4413
	Seven	63615-4419	73615-4419	83615-4419	93615-4419	93618-4419
RWS-Rößler	Titan 3 / Titan 6 / Titan α	63615-4492	73615-4492	83615-4492	93615-4492	93618-4492
	Titan 16	63615-442G	73615-442G	83615-442G	93615-442G	93618-442G
Sabatti	Express	63615-441K	73615-441K	83615-441K	93615-441K	93618-441K
Sako	konisches Prisma / tapered dovetail	63615-4453	73615-4453	83615-4453	93615-4453	93618-4453
Sauer	80 / 90 / 92	63615-4415	73615-4415	83615-4415	93615-4415	93618-4415
	101	63615-442K	73615-442K	83615-442K	93615-442K	93618-442K
	200	63615-4416	73615-4416	83615-4416	93615-4416	93618-4416
	202	63615-4480	73615-4480	83615-4480	93615-4480	93618-4480
Savage	ebene Hülsenbrücke / flat Top	63615-4435	73615-4435	83615-4435	93615-4435	93618-4435
	gerundete Hülsenbrücke / rounded Top	63615-4493	73615-4493	83615-4493	93615-4493	93618-4493
Steyr-Mannlicher	Luxus (siehe Katalog auf Seite 61)					
	SBS-96	63615-4487	73615-4487	83615-4487	93615-4487	93618-4487
	SBS-96 Export/Pro Hunter/Classic/SM12/CLII	63615-4488	73615-4488	83615-4488	93615-4488	93618-4488
Swiss Arms	SHR-970 (Bohrungsabstand 21,9 mm)	63615-4440	73615-4440	83615-4440	93615-4440	93618-4440
Tikka	T3	63615-4481	73615-4481	83615-4481	93615-4481	93618-4481
Verney-Carron	Impact NT / Plus	63615-4447	73615-4447	83615-4447	93615-4447	93618-4447
Voere	LBW	63615-4455	73615-4455	83615-4455	93615-4455	93618-4455
Weatherby	Mark V / 300 / Vanguard	63615-4423	73615-4423	83615-4423	93615-4423	93618-4423
Winchester	70 short / long action	63615-4424	73615-4424	83615-4424	93615-4424	93618-4424
	70 Magnum (Baujahr nach 1964)	63615-4425	73615-4425	83615-4425	93615-4425	93618-4425
	70 WSM	63615-4411	73615-4411	83615-4411	93615-4411	93618-4411
	70 WSSM	63615-4469	73615-4469	83615-4469	93615-4469	93618-4469
	SXR Vulcan	63615-441J	73615-441J	83615-441J	93615-441J	93618-441J
Zastava	70	63615-4401	73615-4401	83615-4401	93615-4401	93618-4401

Swing mounts with steel rings ø 36 mm / Montages pivotants avec colliers ø 36 mm

- ø 36 mm
- Verlängerung 56 mm
- Bauhöhe: 18,5 mm
- Klemmringe aus Stahl
- Ringbreite 15 mm

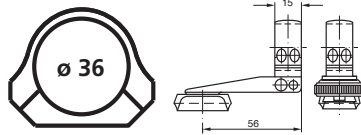

wahlweise mit folgenden ERAMATIC-Verschlüssen lieferbar:

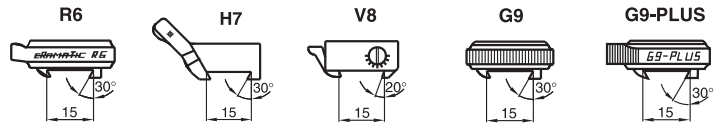

Anschütz	1780 / 1781	63615-562B	73615-562B	83615-562B	93615-562B	93618-562B
Antonio Zoli	1900	63615-5689	73615-5689	83615-5689	93615-5689	93618-5689
Benelli	ARGO	63615-5676	73615-5676	83615-5676	93615-5676	93618-5676
Beretta	689 gold sable / silver sable 2	63615-5699	73615-5699	83615-5699	93615-5699	93618-5699
Brüner CZ	Prisma 16,0 mm	63615-5661	73615-5661	83615-5661	93615-5661	93618-5661
	Prisma 19,5 mm	63615-5662	73615-5662	83615-5662	93615-5662	93618-5662
Chapuis	Express	63615-5629	73615-5629	83615-5629	93615-5629	93618-5629
Fair / Rizzini	Express	63615-5691	73615-5691	83615-5691	93615-5691	93618-5691
FN Browning	A-Bolt	63615-5620	73615-5620	83615-5620	93615-5620	93618-5620
	A-Bolt III	63615-562T	73615-562T	83615-562T	93615-562T	93618-562T
	A-Bolt WSSM	63615-561G	73615-561G	83615-561G	93615-561G	93618-561G
	BAR / BLR / CBL / Acera	63615-5603	73615-5603	83615-5603	93615-5603	93618-5603
	Eurobolt	63615-5678	73615-5678	83615-5678	93615-5678	93618-5678
	European	63615-5656	73615-5656	83615-5656	93615-5656	93618-5656
	Maral	63615-562J	73615-562J	83615-562J	93615-562J	93618-562J
	X-Bolt	63615-561P	73615-561P	83615-561P	93615-561P	93618-561P
Haenel	Jäger 10 (bis Serien-Nr. JX-000920)	63615-561W	73615-561W	83615-561W	93615-561W	93618-561W
	Jäger 10 (ab Serien-Nr. JX-000921)	63615-562C	73615-562C	83615-562C	93615-562C	93618-562C
	SLB 2000+	63615-562I	73615-562I	83615-562I	93615-562I	93618-562I
H&K	SLB 2000	63615-5608	73615-5608	83615-5608	93615-5608	93618-5608
Heym	SR 20	63615-5660	73615-5660	83615-5660	93615-5660	93618-5660
	SR 21	63615-5622	73615-5622	83615-5622	93615-5622	93618-5622
	SR 30	63615-5690	73615-5690	83615-5690	93615-5690	93618-5690
Howa	1500	63615-5659	73615-5659	83615-5659	93615-5659	93618-5659
Krico	600 / 700 / 900 / 902 Deluxe	63615-5606	73615-5606	83615-5606	93615-5606	93618-5606
Krieghoff	Semprio	63615-561C	73615-561C	83615-561C	93615-561C	93618-561C
Mauser	66	63615-5609	73615-5609	83615-5609	93615-5609	93618-5609
	M 94	63615-5694	73615-5694	83615-5694	93615-5694	93618-5694
	M 96	63615-5696	73615-5696	83615-5696	93615-5696	93618-5696
	M 96 (ab Serien-Nr. 12000) / M 97	63615-5697	73615-5697	83615-5697	93615-5697	93618-5697
	K 98 (und Nachbauten)	63615-5610	73615-5610	83615-5610	93615-5610	93618-5610
	M 12	63615-562L	73615-562L	83615-562L	93615-562L	93618-562L
Merkel	SR1	63615-5698	73615-5698	83615-5698	93615-5698	93618-5698
	SR1 Basic	63615-562D	73615-562D	83615-562D	93615-562D	93618-562D
Remington	700 (Gewinde UNS 6-48)	63615-5612	73615-5612	83615-5612	93615-5612	93618-5612
	700 (Gewinde UNS 8-40)	63615-561N	73615-561N	83615-561N	93615-561N	93618-561N
	783	63615-5625	73615-5625	83615-5625	93615-5625	93618-5625
	7400 / 7600 / 750	63615-5613	73615-5613	83615-5613	93615-5613	93618-5613
	Seven	63615-5619	73615-5619	83615-5619	93615-5619	93618-5619
RWS-Rößler	Titan 3 / Titan 6 / Titan α	63615-5692	73615-5692	83615-5692	93615-5692	93618-5692
	Titan 16	63615-562G	73615-562G	83615-562G	93615-562G	93618-562G
Sabatti	Express	63615-561K	73615-561K	83615-561K	93615-561K	93618-561K
Sako	konisches Prisma / tapered dovetail	63615-5653	73615-5653	83615-5653	93615-5653	93618-5653
Sauer	80 / 90 / 92	63615-5615	73615-5615	83615-5615	93615-5615	93618-5615
	101	63615-562K	73615-562K	83615-562K	93615-562K	93618-562K
	200	63615-5616	73615-5616	83615-5616	93615-5616	93618-5616
	202	63615-5680	73615-5680	83615-5680	93615-5680	93618-5680
Savage	ebene Hülsenbrücke / flat Top	63615-5635	73615-5635	83615-5635	93615-5635	93618-5635
	gerundete Hülsenbrücke / rounded Top	63615-5693	73615-5693	83615-5693	93615-5693	93618-5693
Steyr-Mannlicher	Luxus (siehe Katalog auf Seite 61)					
	SBS-96	63615-5687	73615-5687	83615-5687	93615-5687	93618-5687
	SBS-96 Export/Pro Hunter/Classic/SM12/CLII	63615-5688	73615-5688	83615-5688	93615-5688	93618-5688
Swiss Arms	SHR-970 (Bohrungsabstand 21,9 mm)	63615-5640	73615-5640	83615-5640	93615-5640	93618-5640
Tikka	T3	63615-5681	73615-5681	83615-5681	93615-5681	93618-5681
Verney-Carron	Impact NT / Plus	63615-5647	73615-5647	83615-5647	93615-5647	93618-5647
Voere	LBW	63615-5655	73615-5655	83615-5655	93615-5655	93618-5655
Weatherby	Mark V / 300 / Vanguard	63615-5623	73615-5623	83615-5623	93615-5623	93618-5623
Winchester	70 short / long action	63615-5624	73615-5624	83615-5624	93615-5624	93618-5624
	70 Magnum (Baujahr nach 1964)	63615-5625	73615-5625	83615-5625	93615-5625	93618-5625
	70 WSM	63615-5611	73615-5611	83615-5611	93615-5611	93618-5611
	70 WSSM	63615-5669	73615-5669	83615-5669	93615-5669	93618-5669
	SXR Vulcan	63615-561J	73615-561J	83615-561J	93615-561J	93618-561J
Zastava	70	63615-5601	73615-5601	83615-5601	93615-5601	93618-5601

ERAMATIC®-SCHWENKMONTAGEN mit GK-Stahl-Klemmring ø 36 mm

ERAMATIC®-Swing mounts with steel rings ø 36 mm

Ausführungen / Models:

- **Mögliche Verlängerungen:** ohne bzw. mit 38 mm und 56 mm
Available extensions: none (short), 38 mm and 56 mm
- **Bauhöhe / Height:** 18,5 mm
- **Ringbreiten:** vorderer Magnum-Ring 22 mm, hinterer Ring 15 mm
Ring width: front Magnum ring 22 mm, rear ring 15 mm

Eramatic® Verschlussvarianten: Eramatic® lock-up systems:

- R6:** Verschlusskörper mit automatischer Verriegelungstechnik.
Für Prismenbasen und Schienenplatten mit 30°-Prisma.
Rotary locking system with automatic locking mechanism.
Fits all 30° rear dovetail bases and 30° rails.
- H7:** Verschlusskörper mit Entriegelungssicherung mittels Sperrklinke.
Für Prismenbasen und Schienenplatten mit 30°-Prisma.
Locking system with lever and integrated safety catch.
Fits all 30° rear dovetail bases and 30° rails.
- V8:** Verschlusskörper mit Doppelstangenverschluss.
Für Prismenbasen und Schienenplatten mit 20°-Prisma.
Locking system with self-locking clamp.
Fits all 20° rear bases and 20° rails.
- G9:** Verschlusskörper mit integriertem Kurvenspannsystem.
Für Prismenbasen und Schienenplatten mit 30°-Prisma und 15 mm Breite
sowie für 30° Laufschiene mit 12 mm und 14 mm Prismenbreite.
Rotary locking system.
Fits all 30° rear bases and 30° rails with a width of 12 mm, 14 mm or 15 mm.
- G9-Plus:** Verschlusskörper mit integriertem Kurvenspannsystem und geriffeltem Daumennocken.
Für Prismenbasen und Schienenplatten mit 30°-Prisma und 15 mm Breite.
Rotary locking system, specially shaped for easy handling.
Fits all 30° rear bases and 30° rails with a width of 15 mm.

Swing mounts with 22 mm large steel rings ø 36 mm / Montages pivotants avec colliers ø 36 mm, largeur 22 mm

- ø 36 mm
- kurze Ausführung
- Bauhöhe: 18,5 mm
- Klemmringse aus Stahl
- GK-Vorderring 22 mm breit

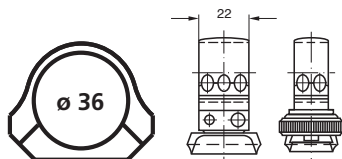

wahlweise mit folgenden ERAMATIC-Verschlüssen lieferbar:

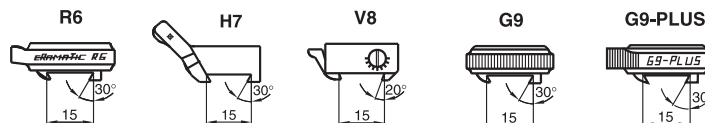

Anschütz	1780 / 1781	63622-002B	73622-002B	83622-002B	93622-002B	93628-002B
Antonio Zoli	1900	63622-0089	73622-0089	83622-0089	93622-0089	93628-0089
Benelli	ARGO	63622-0076	73622-0076	83622-0076	93622-0076	93628-0076
Beretta	689 gold sable / silver sable 2	63622-0099	73622-0099	83622-0099	93622-0099	93628-0099
Brünnner CZ	Prisma 16,0 mm	63622-0061	73622-0061	83622-0061	93622-0061	93628-0061
	Prisma 19,5 mm	63622-0062	73622-0062	83622-0062	93622-0062	93628-0062
Chapuis	Express	63622-0029	73622-0029	83622-0029	93622-0029	93628-0029
Fair / Rizzini	Express	63622-0091	73622-0091	83622-0091	93622-0091	93628-0091
FN Browning	A-Bolt	63622-0020	73622-0020	83622-0020	93622-0020	93628-0020
	A-Bolt III	63622-002T	73622-002T	83622-002T	93622-002T	93628-002T
	A-Bolt WSSM	63622-001G	73622-001G	83622-001G	93622-001G	93628-001G
	BAR / BLR / CBL / Acera	63622-0003	73622-0003	83622-0003	93622-0003	93628-0003
	Eurobolt	63622-0078	73622-0078	83622-0078	93622-0078	93628-0078
	European	63622-0056	73622-0056	83622-0056	93622-0056	93628-0056
	Maral	63622-002J	73622-002J	83622-002J	93622-002J	93628-002J
	X-Bolt	63622-001P	73622-001P	83622-001P	93622-001P	93628-001P
Haenel	Jäger 10 (bis Serien-Nr. JX-000920)	63622-001W	73622-001W	83622-001W	93622-001W	93628-001W
	Jäger 10 (ab Serien-Nr. JX-000921)	63622-002C	73622-002C	83622-002C	93622-002C	93628-002C
	SLB 2000+	63622-002I	73622-002I	83622-002I	93622-002I	93628-002I
H&K	SLB 2000	63622-0008	73622-0008	83622-0008	93622-0008	93628-0008
Heym	SR 20	63622-0060	73622-0060	83622-0060	93622-0060	93628-0060
	SR 21	63622-0022	73622-0022	83622-0022	93622-0022	93628-0022
	SR 30	63622-0090	73622-0090	83622-0090	93622-0090	93628-0090
Howa	1500	63622-0059	73622-0059	83622-0059	93622-0059	93628-0059
Krico	600 / 700 / 900 / 902 Deluxe	63622-0006	73622-0006	83622-0006	93622-0006	93628-0006
Krieghoff	Semprio	63622-001C	73622-001C	83622-001C	93622-001C	93628-001C
Mauser	66	63622-0009	73622-0009	83622-0009	93622-0009	93628-0009
	M 94	63622-0094	73622-0094	83622-0094	93622-0094	93628-0094
	M 96	63622-0096	73622-0096	83622-0096	93622-0096	93628-0096
	M 96 (ab Serien-Nr. 12000) / M 97	63622-0097	73622-0097	83622-0097	93622-0097	93628-0097
	K 98 (und Nachbauten)	63622-0010	73622-0010	83622-0010	93622-0010	93628-0010
	M 12	63622-002L	73622-002L	83622-002L	93622-002L	93628-002L
Merkel	SR1	63622-0098	73622-0098	83622-0098	93622-0098	93628-0098
	SR1 Basic	63622-002D	73622-002D	83622-002D	93622-002D	93628-002D
Remington	700 (Gewinde UNS 6-48)	63622-0012	73622-0012	83622-0012	93622-0012	93628-0012
	700 (Gewinde UNS 8-40)	63622-001N	73622-001N	83622-001N	93622-001N	93628-001N
	783	63622-0025	73622-0025	83622-0025	93622-0025	93628-0025
	7400 / 7600 / 750	63622-0013	73622-0013	83622-0013	93622-0013	93628-0013
	Seven	63622-0019	73622-0019	83622-0019	93622-0019	93628-0019
RWS-Rößler	Titan 3 / Titan 6 / Titan α	63622-0092	73622-0092	83622-0092	93622-0092	93628-0092
	Titan 16	63622-002G	73622-002G	83622-002G	93622-002G	93628-002G
Sabatti	Express	63622-001K	73622-001K	83622-001K	93622-001K	93628-001K
Sako	konisches Prisma / tapered dovetail	63622-0053	73622-0053	83622-0053	93622-0053	93628-0053
Sauer	80 / 90 / 92	63622-0015	73622-0015	83622-0015	93622-0015	93628-0015
	101	63622-002K	73622-002K	83622-002K	93622-002K	93628-002K
	200	63622-0016	73622-0016	83622-0016	93622-0016	93628-0016
	202	63622-0080	73622-0080	83622-0080	93622-0080	93628-0080
Savage	ebene Hülsenbrücke / flat Top	63622-0035	73622-0035	83622-0035	93622-0035	93628-0035
	gerundete Hülsenbrücke / rounded Top	63622-0093	73622-0093	83622-0093	93622-0093	93628-0093
Steyr-Mannlicher	Luxus (siehe Katalog auf Seite 61)					
	SBS-96	63622-0087	73622-0087	83622-0087	93622-0087	93628-0087
	SBS-96 Export/Pro Hunter/Classic/SM12/CLII	63622-0088	73622-0088	83622-0088	93622-0088	93628-0088
Swiss Arms	SHR-970 (Bohrungsabstand 21,9 mm)	63622-0040	73622-0040	83622-0040	93622-0040	93628-0040
Tikka	T3	63622-0081	73622-0081	83622-0081	93622-0081	93628-0081
Verney-Carron	Impact NT / Plus	63622-0047	73622-0047	83622-0047	93622-0047	93628-0047
Voere	LBW	63622-0055	73622-0055	83622-0055	93622-0055	93628-0055
Weatherby	Mark V / 300 / Vanguard	63622-0023	73622-0023	83622-0023	93622-0023	93628-0023
Winchester	70 short / long action	63622-0024	73622-0024	83622-0024	93622-0024	93628-0024
	70 Magnum (Baujahr nach 1964)	63622-0025	73622-0025	83622-0025	93622-0025	93628-0025
	70 WSM	63622-0011	73622-0011	83622-0011	93622-0011	93628-0011
	70 WSSM	63622-0069	73622-0069	83622-0069	93622-0069	93628-0069
	SXR Vulcan	63622-001J	73622-001J	83622-001J	93622-001J	93628-001J
Zastava	70	63622-0001	73622-0001	83622-0001	93622-0001	93628-0001

Swing mounts with 22 mm large steel rings ø 36 mm / Montages pivotants avec colliers ø 36 mm, largeur 22 mm

- ø 36 mm
- Verlängerung 38 mm
- Bauhöhe: 18,5 mm
- Klemmringe aus Stahl
- GK-Vorderring 22 mm breit

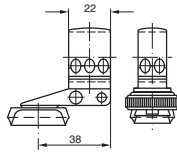

wahlweise mit folgenden ERAMATIC-Verschlüssen lieferbar:

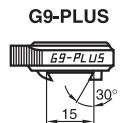
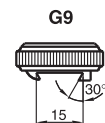
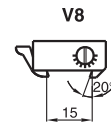
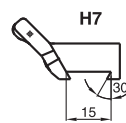
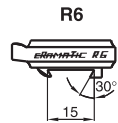

Anschütz	1780 / 1781	63622-382B	73622-382B	83622-382B	93622-382B	93628-382B
Antonio Zoli	1900	63622-3889	73622-3889	83622-3889	93622-3889	93628-3889
Benelli	ARGO	63622-3876	73622-3876	83622-3876	93622-3876	93628-3876
Beretta	689 gold sable / silver sable 2	63622-3899	73622-3899	83622-3899	93622-3899	93628-3899
Brünnner CZ	Prisma 16,0 mm	63622-3861	73622-3861	83622-3861	93622-3861	93628-3861
	Prisma 19,5 mm	63622-3862	73622-3862	83622-3862	93622-3862	93628-3862
Chapuis	Express	63622-3829	73622-3829	83622-3829	93622-3829	93628-3829
Fair / Rizzini	Express	63622-3891	73622-3891	83622-3891	93622-3891	93628-3891
FN Browning	A-Bolt	63622-3820	73622-3820	83622-3820	93622-3820	93628-3820
	A-Bolt III	63622-382T	73622-382T	83622-382T	93622-382T	93628-382T
	A-Bolt WSSM	63622-381G	73622-381G	83622-381G	93622-381G	93628-381G
	BAR / BLR / CBL / Acera	63622-3803	73622-3803	83622-3803	93622-3803	93628-3803
	Eurobolt	63622-3878	73622-3878	83622-3878	93622-3878	93628-3878
	European	63622-3856	73622-3856	83622-3856	93622-3856	93628-3856
	Maral	63622-382J	73622-382J	83622-382J	93622-382J	93628-382J
	X-Bolt	63622-381P	73622-381P	83622-381P	93622-381P	93628-381P
Haenel	Jäger 10 (bis Serien-Nr. JX-000920)	63622-381W	73622-381W	83622-381W	93622-381W	93628-381W
	Jäger 10 (ab Serien-Nr. JX-000921)	63622-382C	73622-382C	83622-382C	93622-382C	93628-382C
	SLB 2000+	63622-382I	73622-382I	83622-382I	93622-382I	93628-382I
H&K	SLB 2000	63622-3808	73622-3808	83622-3808	93622-3808	93628-3808
Heym	SR 20	63622-3860	73622-3860	83622-3860	93622-3860	93628-3860
	SR 21	63622-3822	73622-3822	83622-3822	93622-3822	93628-3822
	SR 30	63622-3890	73622-3890	83622-3890	93622-3890	93628-3890
Howa	1500	63622-3859	73622-3859	83622-3859	93622-3859	93628-3859
Krico	600 / 700 / 900 / 902 Deluxe	63622-3806	73622-3806	83622-3806	93622-3806	93628-3806
Krieghoff	Semprio	63622-381C	73622-381C	83622-381C	93622-381C	93628-381C
Mauser	66	63622-3809	73622-3809	83622-3809	93622-3809	93628-3809
	M 94	63622-3894	73622-3894	83622-3894	93622-3894	93628-3894
	M 96	63622-3896	73622-3896	83622-3896	93622-3896	93628-3896
	M 96 (ab Serien-Nr. 12000) / M 97	63622-3897	73622-3897	83622-3897	93622-3897	93628-3897
	K 98 (und Nachbauten)	63622-3810	73622-3810	83622-3810	93622-3810	93628-3810
	M 12	63622-382L	73622-382L	83622-382L	93622-382L	93628-382L
Merkel	SR1	63622-3898	73622-3898	83622-3898	93622-3898	93628-3898
	SR1 Basic	63622-382D	73622-382D	83622-382D	93622-382D	93628-382D
Remington	700 (Gewinde UNS 6-48)	63622-3812	73622-3812	83622-3812	93622-3812	93628-3812
	700 (Gewinde UNS 8-40)	63622-381N	73622-381N	83622-381N	93622-381N	93628-381N
	783	63622-3825	73622-3825	83622-3825	93622-3825	93628-3825
	7400 / 7600 / 750	63622-3813	73622-3813	83622-3813	93622-3813	93628-3813
	Seven	63622-3819	73622-3819	83622-3819	93622-3819	93628-3819
RWS-Rößler	Titan 3 / Titan 6 / Titan α	63622-3892	73622-3892	83622-3892	93622-3892	93628-3892
	Titan 16	63622-382G	73622-382G	83622-382G	93622-382G	93628-382G
Sabatti	Express	63622-381K	73622-381K	83622-381K	93622-381K	93628-381K
Sako	konisches Prisma / tapered dovetail	63622-3853	73622-3853	83622-3853	93622-3853	93628-3853
Sauer	80 / 90 / 92	63622-3815	73622-3815	83622-3815	93622-3815	93628-3815
	101	63622-382K	73622-382K	83622-382K	93622-382K	93628-382K
	200	63622-3816	73622-3816	83622-3816	93622-3816	93628-3816
	202	63622-3880	73622-3880	83622-3880	93622-3880	93628-3880
Savage	ebene Hülsenbrücke / flat Top	63622-3835	73622-3835	83622-3835	93622-3835	93628-3835
	gerundete Hülsenbrücke / rounded Top	63622-3893	73622-3893	83622-3893	93622-3893	93628-3893
Steyr-Mannlicher	Luxus (siehe Katalog auf Seite 61)					
	SBS-96	63622-3887	73622-3887	83622-3887	93622-3887	93628-3887
	SBS-96 Export/Pro Hunter/Classic/SM12/CLII	63622-3888	73622-3888	83622-3888	93622-3888	93628-3888
Swiss Arms	SHR-970 (Bohrungsabstand 21,9 mm)	63622-3840	73622-3840	83622-3840	93622-3840	93628-3840
Tikka	T3	63622-3881	73622-3881	83622-3881	93622-3881	93628-3881
Verney-Carron	Impact NT / Plus	63622-3847	73622-3847	83622-3847	93622-3847	93628-3847
Voere	LBW	63622-3855	73622-3855	83622-3855	93622-3855	93628-3855
Weatherby	Mark V / 300 / Vanguard	63622-3823	73622-3823	83622-3823	93622-3823	93628-3823
Winchester	70 short / long action	63622-3824	73622-3824	83622-3824	93622-3824	93628-3824
	70 Magnum (Baujahr nach 1964)	63622-3825	73622-3825	83622-3825	93622-3825	93628-3825
	70 WSM	63622-3811	73622-3811	83622-3811	93622-3811	93628-3811
	70 WSSM	63622-3869	73622-3869	83622-3869	93622-3869	93628-3869
	SRX Vulcan	63622-381J	73622-381J	83622-381J	93622-381J	93628-381J
Zastava	70	63622-3801	73622-3801	83622-3801	93622-3801	93628-3801

Swing mounts with 22 mm large steel rings ø 36 mm / Montages pivotants avec colliers ø 36 mm, largeur 22 mm

- ø 36 mm
- Verlängerung 56 mm
- Bauhöhe: 18,5 mm
- Klemmringe aus Stahl
- GK-Vorderring 22 mm breit

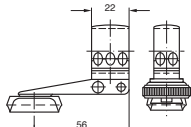

wahlweise mit folgenden ERAMATIC-Verschlüssen lieferbar:

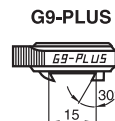
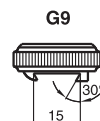
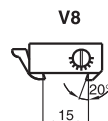
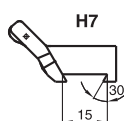
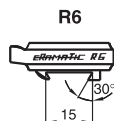

Anschütz	1780 / 1781	63622-562B	73622-562B	83622-562B	93622-562B	93628-562B
Antonio Zoli	1900	63622-5689	73622-5689	83622-5689	93622-5689	93628-5689
Benelli	ARGO	63622-5676	73622-5676	83622-5676	93622-5676	93628-5676
Beretta	689 gold sable / silver sable 2	63622-5699	73622-5699	83622-5699	93622-5699	93628-5699
Brünnner CZ	Prisma 16,0 mm	63622-5661	73622-5661	83622-5661	93622-5661	93628-5661
	Prisma 19,5 mm	63622-5662	73622-5662	83622-5662	93622-5662	93628-5662
Chapuis	Express	63622-5629	73622-5629	83622-5629	93622-5629	93628-5629
Fair / Rizzini	Express	63622-5691	73622-5691	83622-5691	93622-5691	93628-5691
FN Browning	A-Bolt	63622-5620	73622-5620	83622-5620	93622-5620	93628-5620
	A-Bolt III	63622-562T	73622-562T	83622-562T	93622-562T	93628-562T
	A-Bolt WSSM	63622-561G	73622-561G	83622-561G	93622-561G	93628-561G
	BAR / BLR / CBL / Acera	63622-5603	73622-5603	83622-5603	93622-5603	93628-5603
	Eurobolt	63622-5678	73622-5678	83622-5678	93622-5678	93628-5678
	European	63622-5656	73622-5656	83622-5656	93622-5656	93628-5656
	Maral	63622-562J	73622-562J	83622-562J	93622-562J	93628-562J
	X-Bolt	63622-561P	73622-561P	83622-561P	93622-561P	93628-561P
Haenel	Jäger 10 (bis Serien-Nr. JX-000920)	63622-561W	73622-561W	83622-561W	93622-561W	93628-561W
	Jäger 10 (ab Serien-Nr. JX-000921)	63622-562C	73622-562C	83622-562C	93622-562C	93628-562C
	SLB 2000+	63622-562I	73622-562I	83622-562I	93622-562I	93628-562I
H&K	SLB 2000	63622-5608	73622-5608	83622-5608	93622-5608	93628-5608
Heym	SR 20	63622-5660	73622-5660	83622-5660	93622-5660	93628-5660
	SR 21	63622-5622	73622-5622	83622-5622	93622-5622	93628-5622
	SR 30	63622-5690	73622-5690	83622-5690	93622-5690	93628-5690
Howa	1500	63622-5659	73622-5659	83622-5659	93622-5659	93628-5659
Krico	600 / 700 / 900 / 902 Deluxe	63622-5606	73622-5606	83622-5606	93622-5606	93628-5606
Krieghoff	Semprio	63622-561C	73622-561C	83622-561C	93622-561C	93628-561C
Mauser	66	63622-5609	73622-5609	83622-5609	93622-5609	93628-5609
	M 94	63622-5694	73622-5694	83622-5694	93622-5694	93628-5694
	M 96	63622-5696	73622-5696	83622-5696	93622-5696	93628-5696
	M 96 (ab Serien-Nr. 12000) / M 97	63622-5697	73622-5697	83622-5697	93622-5697	93628-5697
	K 98 (und Nachbauten)	63622-5610	73622-5610	83622-5610	93622-5610	93628-5610
	M 12	63622-562L	73622-562L	83622-562L	93622-562L	93628-562L
Merkel	SR1	63622-5698	73622-5698	83622-5698	93622-5698	93628-5698
	SR1 Basic	63622-562D	73622-562D	83622-562D	93622-562D	93628-562D
Remington	700 (Gewinde UNS 6-48)	63622-5612	73622-5612	83622-5612	93622-5612	93628-5612
	700 (Gewinde UNS 8-40)	63622-561N	73622-561N	83622-561N	93622-561N	93628-561N
	783	63622-5625	73622-5625	83622-5625	93622-5625	93628-5625
	7400 / 7600 / 750	63622-5613	73622-5613	83622-5613	93622-5613	93628-5613
	Seven	63622-5619	73622-5619	83622-5619	93622-5619	93628-5619
RWS-Rößler	Titan 3 / Titan 6 / Titan α	63622-5692	73622-5692	83622-5692	93622-5692	93628-5692
	Titan 16	63622-562G	73622-562G	83622-562G	93622-562G	93628-562G
Sabatti	Express	63622-561K	73622-561K	83622-561K	93622-561K	93628-561K
Sako	konisches Prisma / tapered dovetail	63622-5653	73622-5653	83622-5653	93622-5653	93628-5653
Sauer	80 / 90 / 92	63622-5615	73622-5615	83622-5615	93622-5615	93628-5615
	101	63622-562K	73622-562K	83622-562K	93622-562K	93628-562K
	200	63622-5616	73622-5616	83622-5616	93622-5616	93628-5616
	202	63622-5680	73622-5680	83622-5680	93622-5680	93628-5680
Savage	ebene Hülsenbrücke / flat Top	63622-5635	73622-5635	83622-5635	93622-5635	93628-5635
	gerundete Hülsenbrücke / rounded Top	63622-5693	73622-5693	83622-5693	93622-5693	93628-5693
Steyr-Mannlicher	Luxus (siehe Katalog auf Seite 61)					
	SBS-96	63622-5687	73622-5687	83622-5687	93622-5687	93628-5687
	SBS-96 Export/Pro Hunter/Classic/SM12/CLII	63622-5688	73622-5688	83622-5688	93622-5688	93628-5688
Swiss Arms	SHR-970 (Bohrungsabstand 21,9 mm)	63622-5640	73622-5640	83622-5640	93622-5640	93628-5640
Tikka	T3	63622-5681	73622-5681	83622-5681	93622-5681	93628-5681
Verney-Carron	Impact NT / Plus	63622-5647	73622-5647	83622-5647	93622-5647	93628-5647
Voere	LBW	63622-5655	73622-5655	83622-5655	93622-5655	93628-5655
Weatherby	Mark V / 300 / Vanguard	63622-5623	73622-5623	83622-5623	93622-5623	93628-5623
Winchester	70 short / long action	63622-5624	73622-5624	83622-5624	93622-5624	93628-5624
	70 Magnum (Baujahr nach 1964)	63622-5625	73622-5625	83622-5625	93622-5625	93628-5625
	70 WSM	63622-5611	73622-5611	83622-5611	93622-5611	93628-5611
	70 WSSM	63622-5669	73622-5669	83622-5669	93622-5669	93628-5669
	SXR Vulcan	63622-561J	73622-561J	83622-561J	93622-561J	93628-561J
Zastava	70	63622-5601	73622-5601	83622-5601	93622-5601	93628-5601

ERAMATIC®-SCHWENKMONTAGEN mit GK-Stahl-Klemmring ø 40 mm

ERAMATIC®-Swing mounts with steel rings ø 40 mm

Ausführungen / Models:

- **Mögliche Verlängerungen:** ohne bzw. mit 38 mm und 56 mm
Available extensions: none (short), 38 mm and 56 mm
- **Bauhöhe / Height:** 18,5 mm
- **Ringbreiten:** vorderer Magnum-Ring 22 mm, hinterer Ring 15 mm
Ring width: front Magnum ring 22 mm, rear ring 15 mm

Eramatic® Verschlussvarianten: Eramatic® lock-up systems:

- R6:** Verschlusskörper mit automatischer Verriegelungstechnik.
Für Prismenbasen und Schienenplatten mit 30°-Prisma.
Rotary locking system with automatic locking mechanism.
Fits all 30° rear dovetail bases and 30° rails.
- H7:** Verschlusskörper mit Entriegelungssicherung mittels Sperrklinke.
Für Prismenbasen und Schienenplatten mit 30°-Prisma.
Locking system with lever and integrated safety catch.
Fits all 30° rear dovetail bases and 30° rails.
- V8:** Verschlusskörper mit Doppelstangenverschluss.
Für Prismenbasen und Schienenplatten mit 20°-Prisma.
Locking system with self-locking clamp.
Fits all 20° rear bases and 20° rails.
- G9:** Verschlusskörper mit integriertem Kurvenspannsystem.
Für Prismenbasen und Schienenplatten mit 30°-Prisma und 15 mm Breite
sowie für 30° Laufschiene mit 12 mm und 14 mm Prismenbreite.
Rotary locking system.
Fits all 30° rear bases and 30° rails with a width of 12 mm, 14 mm or 15 mm.
- G9-Plus:** Verschlusskörper mit integriertem Kurvenspannsystem und geriffeltem Daumennocken.
Für Prismenbasen und Schienenplatten mit 30°-Prisma und 15 mm Breite.
Rotary locking system, specially shaped for easy handling.
Fits all 30° rear bases and 30° rails with a width of 15 mm.

Swing mounts with 22 mm large steel rings ø 40 mm / Montages pivotants avec colliers ø 40 mm, largeur 22 mm

- ø 40 mm
- kurze Ausführung
- Bauhöhe: 18,5 mm
- Klemmringse aus Stahl
- GK-Vorderring 22 mm breit

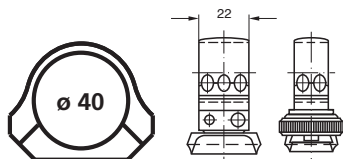

wahlweise mit folgenden ERAMATIC-Verschlüssen lieferbar:

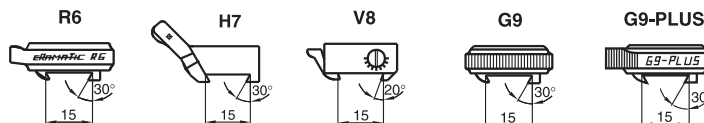

Anschütz	1780 / 1781	64022-002B	74022-002B	84022-002B	94022-002B	94028-002B
Antonio Zoli	1900	64022-0089	74022-0089	84022-0089	94022-0089	94028-0089
Benelli	ARGO	64022-0076	74022-0076	84022-0076	94022-0076	94028-0076
Beretta	689 gold sable / silver sable 2	64022-0099	74022-0099	84022-0099	94022-0099	94028-0099
Brüner CZ	Prisma 16,0 mm	64022-0061	74022-0061	84022-0061	94022-0061	94028-0061
	Prisma 19,5 mm	64022-0062	74022-0062	84022-0062	94022-0062	94028-0062
Chapuis	Express	64022-0029	74022-0029	84022-0029	94022-0029	94028-0029
Fair / Rizzini	Express	64022-0091	74022-0091	84022-0091	94022-0091	94028-0091
FN Browning	A-Bolt	64022-0020	74022-0020	84022-0020	94022-0020	94028-0020
	A-Bolt III	64022-002T	74022-002T	84022-002T	94022-002T	94028-002T
	A-Bolt WSSM	64022-001G	74022-001G	84022-001G	94022-001G	94028-001G
	BAR / BLR / CBL / Acera	64022-0003	74022-0003	84022-0003	94022-0003	94028-0003
	Eurobolt	64022-0078	74022-0078	84022-0078	94022-0078	94028-0078
	European	64022-0056	74022-0056	84022-0056	94022-0056	94028-0056
	Maral	64022-002J	74022-002J	84022-002J	94022-002J	94028-002J
	X-Bolt	64022-001P	74022-001P	84022-001P	94022-001P	94028-001P
Haenel	Jäger 10 (bis Serien-Nr. JX-000920)	64022-001W	74022-001W	84022-001W	94022-001W	94028-001W
	Jäger 10 (ab Serien-Nr. JX-000921)	64022-002C	74022-002C	84022-002C	94022-002C	94028-002C
	SLB 2000+	64022-002I	74022-002I	84022-002I	94022-002I	94028-002I
H&K	SLB 2000	64022-0008	74022-0008	84022-0008	94022-0008	94028-0008
Heym	SR 20	64022-0060	74022-0060	84022-0060	94022-0060	94028-0060
	SR 21	64022-0022	74022-0022	84022-0022	94022-0022	94028-0022
	SR 30	64022-0090	74022-0090	84022-0090	94022-0090	94028-0090
Howa	1500	64022-0059	74022-0059	84022-0059	94022-0059	94028-0059
Krico	600 / 700 / 900 / 902 Deluxe	64022-0006	74022-0006	84022-0006	94022-0006	94028-0006
Krieghoff	Semprio	64022-001C	74022-001C	84022-001C	94022-001C	94028-001C
Mauser	66	64022-0009	74022-0009	84022-0009	94022-0009	94028-0009
	M 94	64022-0094	74022-0094	84022-0094	94022-0094	94028-0094
	M 96	64022-0096	74022-0096	84022-0096	94022-0096	94028-0096
	M 96 (ab Serien-Nr. 12000) / M 97	64022-0097	74022-0097	84022-0097	94022-0097	94028-0097
	K 98 (und Nachbauten)	64022-0010	74022-0010	84022-0010	94022-0010	94028-0010
	M 12	64022-002L	74022-002L	84022-002L	94022-002L	94028-002L
Merkel	SR1	64022-0098	74022-0098	84022-0098	94022-0098	94028-0098
	SR1 Basic	64022-002D	74022-002D	84022-002D	94022-002D	94028-002D
Remington	700 (Gewinde UNS 6-48)	64022-0012	74022-0012	84022-0012	94022-0012	94028-0012
	700 (Gewinde UNS 8-40)	64022-001N	74022-001N	84022-001N	94022-001N	94028-001N
	783	64022-0025	74022-0025	84022-0025	94022-0025	94028-0025
	7400 / 7600 / 750	64022-0013	74022-0013	84022-0013	94022-0013	94028-0013
	Seven	64022-0019	74022-0019	84022-0019	94022-0019	94028-0019
RWS-Röbler	Titan 3 / Titan 6 / Titan α	64022-0092	74022-0092	84022-0092	94022-0092	94028-0092
	Titan 16	64022-002G	74022-002G	84022-002G	94022-002G	94028-002G
Sabatti	Express	64022-001K	74022-001K	84022-001K	94022-001K	94028-001K
Sako	konisches Prisma / tapered dovetail	64022-0053	74022-0053	84022-0053	94022-0053	94028-0053
Sauer	80 / 90 / 92	64022-0015	74022-0015	84022-0015	94022-0015	94028-0015
	101	64022-002K	74022-002K	84022-002K	94022-002K	94028-002K
	200	64022-0016	74022-0016	84022-0016	94022-0016	94028-0016
	202	64022-0080	74022-0080	84022-0080	94022-0080	94028-0080
Savage	ebene Hülsenbrücke / flat Top	64022-0035	74022-0035	84022-0035	94022-0035	94028-0035
	gerundete Hülsenbrücke / rounded Top	64022-0093	74022-0093	84022-0093	94022-0093	94028-0093
Steyr-Mannlicher	Luxus (siehe Katalog auf Seite 61)					
	SBS-96	64022-0087	74022-0087	84022-0087	94022-0087	94028-0087
	SBS-96 Export/Pro Hunter/Classic/SM12/CLII	64022-0088	74022-0088	84022-0088	94022-0088	94028-0088
Swiss Arms	SHR-970 (Bohrungsabstand 21,9 mm)	64022-0040	74022-0040	84022-0040	94022-0040	94028-0040
Tikka	T3	64022-0081	74022-0081	84022-0081	94022-0081	94028-0081
Verney-Carron	Impact NT / Plus	64022-0047	74022-0047	84022-0047	94022-0047	94028-0047
Voere	LBW	64022-0055	74022-0055	84022-0055	94022-0055	94028-0055
Weatherby	Mark V / 300 / Vanguard	64022-0023	74022-0023	84022-0023	94022-0023	94028-0023
Winchester	70 short / long action	64022-0024	74022-0024	84022-0024	94022-0024	94028-0024
	70 Magnum (Baujahr nach 1964)	64022-0025	74022-0025	84022-0025	94022-0025	94028-0025
	70 WSM	64022-0011	74022-0011	84022-0011	94022-0011	94028-0011
	70 WSSM	64022-0069	74022-0069	84022-0069	94022-0069	94028-0069
	SXR Vulcan	64022-001J	74022-001J	84022-001J	94022-001J	94028-001J
Zastava	70	64022-0001	74022-0001	84022-0001	94022-0001	94028-0001

Swing mounts with 22 mm large steel rings ø 40 mm / Montages pivotants avec colliers ø 40 mm, largeur 22 mm

- ø 40 mm
- Verlängerung 38 mm
- Bauhöhe: 18,5 mm
- Klemmringe aus Stahl
- GK-Vorderring 22 mm breit

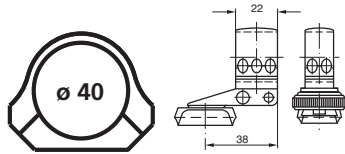

wahlweise mit folgenden ERAMATIC-Verschlüssen lieferbar:

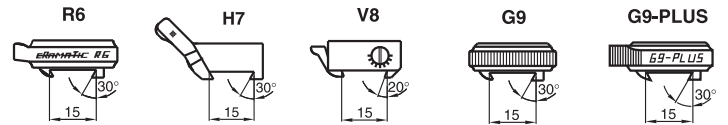

Anschütz	1780 / 1781	64022-382B	74022-382B	84022-382B	94022-382B	94028-382B
Antonio Zoli	1900	64022-3889	74022-3889	84022-3889	94022-3889	94028-3889
Benelli	ARGO	64022-3876	74022-3876	84022-3876	94022-3876	94028-3876
Beretta	689 gold sable / silver sable 2	64022-3899	74022-3899	84022-3899	94022-3899	94028-3899
Brünnner CZ	Prisma 16,0 mm	64022-3861	74022-3861	84022-3861	94022-3861	94028-3861
	Prisma 19,5 mm	64022-3862	74022-3862	84022-3862	94022-3862	94028-3862
Chapuis	Express	64022-3829	74022-3829	84022-3829	94022-3829	94028-3829
Fair / Rizzini	Express	64022-3891	74022-3891	84022-3891	94022-3891	94028-3891
FN Browning	A-Bolt	64022-3820	74022-3820	84022-3820	94022-3820	94028-3820
	A-Bolt III	64022-382T	74022-382T	84022-382T	94022-382T	94028-382T
	A-Bolt WSSM	64022-381G	74022-381G	84022-381G	94022-381G	94028-381G
	BAR / BLR / CBL / Acera	64022-3803	74022-3803	84022-3803	94022-3803	94028-3803
	Eurobolt	64022-3878	74022-3878	84022-3878	94022-3878	94028-3878
	European	64022-3856	74022-3856	84022-3856	94022-3856	94028-3856
	Maral	64022-382J	74022-382J	84022-382J	94022-382J	94028-382J
	X-Bolt	64022-381P	74022-381P	84022-381P	94022-381P	94028-381P
Haenel	Jäger 10 (bis Serien-Nr. JX-000920)	64022-381W	74022-381W	84022-381W	94022-381W	94028-381W
	Jäger 10 (ab Serien-Nr. JX-000921)	64022-382C	74022-382C	84022-382C	94022-382C	94028-382C
	SLB 2000+	64022-382I	74022-382I	84022-382I	94022-382I	94028-382I
H&K	SLB 2000	64022-3808	74022-3808	84022-3808	94022-3808	94028-3808
Heym	SR 20	64022-3860	74022-3860	84022-3860	94022-3860	94028-3860
	SR 21	64022-3822	74022-3822	84022-3822	94022-3822	94028-3822
	SR 30	64022-3890	74022-3890	84022-3890	94022-3890	94028-3890
Howa	1500	64022-3859	74022-3859	84022-3859	94022-3859	94028-3859
Krico	600 / 700 / 900 / 902 Deluxe	64022-3806	74022-3806	84022-3806	94022-3806	94028-3806
Krieghoff	Semprio	64022-381C	74022-381C	84022-381C	94022-381C	94028-381C
Mauser	66	64022-3809	74022-3809	84022-3809	94022-3809	94028-3809
	M 94	64022-3894	74022-3894	84022-3894	94022-3894	94028-3894
	M 96	64022-3896	74022-3896	84022-3896	94022-3896	94028-3896
	M 96 (ab Serien-Nr. 12000) / M 97	64022-3897	74022-3897	84022-3897	94022-3897	94028-3897
	K 98 (und Nachbauten)	64022-3810	74022-3810	84022-3810	94022-3810	94028-3810
	M 12	64022-382L	74022-382L	84022-382L	94022-382L	94028-382L
Merkel	SR1	64022-3898	74022-3898	84022-3898	94022-3898	94028-3898
	SR1 Basic	64022-382D	74022-382D	84022-382D	94022-382D	94028-382D
Remington	700 (Gewinde UNS 6-48)	64022-3812	74022-3812	84022-3812	94022-3812	94028-3812
	700 (Gewinde UNS 8-40)	64022-381N	74022-381N	84022-381N	94022-381N	94028-381N
	783	64022-3825	74022-3825	84022-3825	94022-3825	94028-3825
	7400 / 7600 / 750	64022-3813	74022-3813	84022-3813	94022-3813	94028-3813
	Seven	64022-3819	74022-3819	84022-3819	94022-3819	94028-3819
RWS-Rößler	Titan 3 / Titan 6 / Titan α	64022-3892	74022-3892	84022-3892	94022-3892	94028-3892
	Titan 16	64022-382G	74022-382G	84022-382G	94022-382G	94028-382G
Sabatti	Express	64022-381K	74022-381K	84022-381K	94022-381K	94028-381K
Sako	konisches Prisma / tapered dovetail	64022-3853	74022-3853	84022-3853	94022-3853	94028-3853
Sauer	80 / 90 / 92	64022-3815	74022-3815	84022-3815	94022-3815	94028-3815
	101	64022-382K	74022-382K	84022-382K	94022-382K	94028-382K
	200	64022-3816	74022-3816	84022-3816	94022-3816	94028-3816
	202	64022-3880	74022-3880	84022-3880	94022-3880	94028-3880
Savage	ebene Hülsenbrücke / flat Top	64022-3835	74022-3835	84022-3835	94022-3835	94028-3835
	gerundete Hülsenbrücke / rounded Top	64022-3893	74022-3893	84022-3893	94022-3893	94028-3893
Steyr-Mannlicher	Luxus (siehe Katalog auf Seite 61)					
	SBS-96	64022-3887	74022-3887	84022-3887	94022-3887	94028-3887
	SBS-96 Export/Pro Hunter/Classic/SM12/CLII	64022-3888	74022-3888	84022-3888	94022-3888	94028-3888
Swiss Arms	SHR-970 (Bohrungsabstand 21,9 mm)	64022-3840	74022-3840	84022-3840	94022-3840	94028-3840
Tikka	T3	64022-3881	74022-3881	84022-3881	94022-3881	94028-3881
Verney-Carron	Impact NT / Plus	64022-3847	74022-3847	84022-3847	94022-3847	94028-3847
Voere	LBW	64022-3855	74022-3855	84022-3855	94022-3855	94028-3855
Weatherby	Mark V / 300 / Vanguard	64022-3823	74022-3823	84022-3823	94022-3823	94028-3823
Winchester	70 short / long action	64022-3824	74022-3824	84022-3824	94022-3824	94028-3824
	70 Magnum (Baujahr nach 1964)	64022-3825	74022-3825	84022-3825	94022-3825	94028-3825
	70 WSM	64022-3811	74022-3811	84022-3811	94022-3811	94028-3811
	70 WSSM	64022-3869	74022-3869	84022-3869	94022-3869	94028-3869
	SXR Vulcan	64022-381J	74022-381J	84022-381J	94022-381J	94028-381J
Zastava	70	64022-3801	74022-3801	84022-3801	94022-3801	94028-3801

Swing mounts with 22 mm large steel rings ø 40 mm / Montages pivotants avec colliers ø 40 mm, largeur 22 mm

- ø 40 mm
- Verlängerung 56 mm
- Bauhöhe: 18,5 mm
- Klemmringse aus Stahl
- GK-Vorderring 22 mm breit

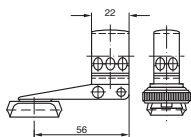

wahlweise mit folgenden ERAMATIC-Verschlüssen lieferbar:

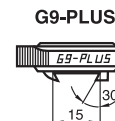
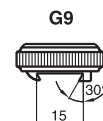
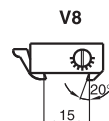
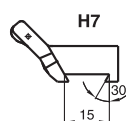
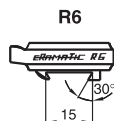

Anschütz	1780 / 1781	64022-562B	74022-562B	84022-562B	94022-562B	94028-562B
Antonio Zoli	1900	64022-5689	74022-5689	84022-5689	94022-5689	94028-5689
Benelli	ARGO	64022-5676	74022-5676	84022-5676	94022-5676	94028-5676
Beretta	689 gold sable / silver sable 2	64022-5699	74022-5699	84022-5699	94022-5699	94028-5699
Brügger CZ	Prisma 16,0 mm	64022-5661	74022-5661	84022-5661	94022-5661	94028-5661
	Prisma 19,5 mm	64022-5662	74022-5662	84022-5662	94022-5662	94028-5662
Chapuis	Express	64022-5629	74022-5629	84022-5629	94022-5629	94028-5629
Fair / Rizzini	Express	64022-5691	74022-5691	84022-5691	94022-5691	94028-5691
FN Browning	A-Bolt	64022-5620	74022-5620	84022-5620	94022-5620	94028-5620
	A-Bolt III	64022-562T	74022-562T	84022-562T	94022-562T	94028-562T
	A-Bolt WSSM	64022-561G	74022-561G	84022-561G	94022-561G	94028-561G
	BAR / BLR / CBL / Acera	64022-5603	74022-5603	84022-5603	94022-5603	94028-5603
	Eurobolt	64022-5678	74022-5678	84022-5678	94022-5678	94028-5678
	European	64022-5656	74022-5656	84022-5656	94022-5656	94028-5656
	Maral	64022-562J	74022-562J	84022-562J	94022-562J	94028-562J
	X-Bolt	64022-561P	74022-561P	84022-561P	94022-561P	94028-561P
Haenel	Jäger 10 (bis Serien-Nr. JX-000920)	64022-561W	74022-561W	84022-561W	94022-561W	94028-561W
	Jäger 10 (ab Serien-Nr. JX-000921)	64022-562C	74022-562C	84022-562C	94022-562C	94028-562C
	SLB 2000+	64022-562I	74022-562I	84022-562I	94022-562I	94028-562I
H&K	SLB 2000	64022-5608	74022-5608	84022-5608	94022-5608	94028-5608
Heym	SR 20	64022-5660	74022-5660	84022-5660	94022-5660	94028-5660
	SR 21	64022-5622	74022-5622	84022-5622	94022-5622	94028-5622
	SR 30	64022-5690	74022-5690	84022-5690	94022-5690	94028-5690
Howa	1500	64022-5659	74022-5659	84022-5659	94022-5659	94028-5659
Krico	600 / 700 / 900 / 902 Deluxe	64022-5606	74022-5606	84022-5606	94022-5606	94028-5606
Krieghoff	Semprio	64022-561C	74022-561C	84022-561C	94022-561C	94028-561C
Mauser	66	64022-5609	74022-5609	84022-5609	94022-5609	94028-5609
	M 94	64022-5694	74022-5694	84022-5694	94022-5694	94028-5694
	M 96	64022-5696	74022-5696	84022-5696	94022-5696	94028-5696
	M 96 (ab Serien-Nr. 12000) / M 97	64022-5697	74022-5697	84022-5697	94022-5697	94028-5697
	K 98 (und Nachbauten)	64022-5610	74022-5610	84022-5610	94022-5610	94028-5610
	M 12	64022-562L	74022-562L	84022-562L	94022-562L	94028-562L
Merkel	SR1	64022-5698	74022-5698	84022-5698	94022-5698	94028-5698
	SR1 Basic	64022-562D	74022-562D	84022-562D	94022-562D	94028-562D
Remington	700 (Gewinde UNS 6-48)	64022-5612	74022-5612	84022-5612	94022-5612	94028-5612
	700 (Gewinde UNS 8-40)	64022-561N	74022-561N	84022-561N	94022-561N	94028-561N
	783	64022-5625	74022-5625	84022-5625	94022-5625	94028-5625
	7400 / 7600 / 750	64022-5613	74022-5613	84022-5613	94022-5613	94028-5613
	Seven	64022-5619	74022-5619	84022-5619	94022-5619	94028-5619
RWS-Röbber	Titan 3 / Titan 6 / Titan α	64022-5692	74022-5692	84022-5692	94022-5692	94028-5692
	Titan 16	64022-562G	74022-562G	84022-562G	94022-562G	94028-562G
Sabatti	Express	64022-561K	74022-561K	84022-561K	94022-561K	94028-561K
Sako	konisches Prisma / tapered dovetail	64022-5653	74022-5653	84022-5653	94022-5653	94028-5653
Sauer	80 / 90 / 92	64022-5615	74022-5615	84022-5615	94022-5615	94028-5615
	101	64022-562K	74022-562K	84022-562K	94022-562K	94028-562K
	200	64022-5616	74022-5616	84022-5616	94022-5616	94028-5616
	202	64022-5680	74022-5680	84022-5680	94022-5680	94028-5680
Savage	ebene Hülsenbrücke / flat Top	64022-5635	74022-5635	84022-5635	94022-5635	94028-5635
	gerundete Hülsenbrücke / rounded Top	64022-5693	74022-5693	84022-5693	94022-5693	94028-5693
Steyr-Mannlicher	Luxus (siehe Katalog auf Seite 61)					
	SBS-96	64022-5687	74022-5687	84022-5687	94022-5687	94028-5687
	SBS-96 Export/Pro Hunter/Classic/SM12/CLII	64022-5688	74022-5688	84022-5688	94022-5688	94028-5688
Swiss Arms	SHR-970 (Bohrungsabstand 21,9 mm)	64022-5640	74022-5640	84022-5640	94022-5640	94028-5640
Tikka	T3	64022-5681	74022-5681	84022-5681	94022-5681	94028-5681
Verney-Carron	Impact NT / Plus	64022-5647	74022-5647	84022-5647	94022-5647	94028-5647
Voere	LBW	64022-5655	74022-5655	84022-5655	94022-5655	94028-5655
Weatherby	Mark V / 300 / Vanguard	64022-5623	74022-5623	84022-5623	94022-5623	94028-5623
Winchester	70 short / long action	64022-5624	74022-5624	84022-5624	94022-5624	94028-5624
	70 Magnum (Baujahr nach 1964)	64022-5625	74022-5625	84022-5625	94022-5625	94028-5625
	70 WSM	64022-5611	74022-5611	84022-5611	94022-5611	94028-5611
	70 WSSM	64022-5669	74022-5669	84022-5669	94022-5669	94028-5669
	SXR Vulcan	64022-561J	74022-561J	84022-561J	94022-561J	94028-561J
Zastava	70	64022-5601	74022-5601	84022-5601	94022-5601	94028-5601

ERAMATIC®-SCHWENKMONTAGEN mit diversen Aufnahmeprismen

ERAMATIC®-Swing mounts with dovetail attachments

Ausführungen / Models:

- **Mögliche Verlängerungen:** ohne bzw. mit 26 mm*, 31 mm*, 38 mm, 44 mm* und 56 mm
Available extensions: none (short), 26 mm*, 31 mm*, 38 mm, 44 mm* and 56 mm
- **Bauhöhe / Height:** 18,5 mm
- **Ringbreite / Ring width:** 15,0 mm

* nur bei 70°-Aufnahmeprismen / available only for 70° dovetail attachments

Eramatic® Verschlussvarianten: Eramatic® lock-up systems:

- R6:** Verschlusskörper mit automatischer Verriegelungstechnik.
Für Prismenbasen und Schienenplatten mit 30°-Prisma.
Rotary locking system with automatic locking mechanism.
Fits all 30° rear dovetail bases and 30° rails.
- H7:** Verschlusskörper mit Entriegelungssicherung mittels Sperrklinke.
Für Prismenbasen und Schienenplatten mit 30°-Prisma.
Locking system with lever and integrated safety catch.
Fits all 30° rear dovetail bases and 30° rails.
- V8:** Verschlusskörper mit Doppelstangenverschluss.
Für Prismenbasen und Schienenplatten mit 20°-Prisma.
Locking system with self-locking clamp.
Fits all 20° rear bases and 20° rails.
- G9:** Verschlusskörper mit integriertem Kurvenspannsystem.
Für Prismenbasen und Schienenplatten mit 30°-Prisma und 15 mm Breite sowie für 30° Laufschiene mit 12 mm und 14 mm Prismenbreite.
Rotary locking system.
Fits all 30° rear bases and 30° rails with a width of 12 mm, 14 mm or 15 mm.
- G9-Plus:** Verschlusskörper mit integriertem Kurvenspannsystem und geriffeltem Daumennocken.
Für Prismenbasen und Schienenplatten mit 30°-Prisma und 15 mm Breite.
Rotary locking system, specially shaped for easy handling.
Fits all 30° rear bases and 30° rails with a width of 15 mm.

Swing mounts with 70° dovetail attachments / Montages pivotants avec 70° prisme

wahlweise mit folgenden ERAMATIC-Verschlüssen lieferbar:

- 70° Aufnahmeprisma
- kurze Ausführung
- Bauhöhe: 18,5 mm
- Prismenbreite 22 mm

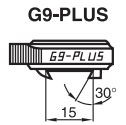
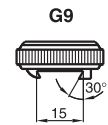
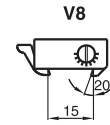
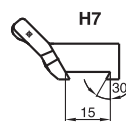
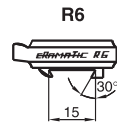
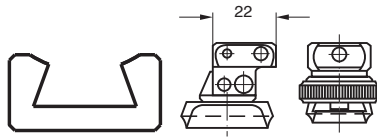

Anschütz	1780 / 1781	67022-002B	77022-002B	87022-002B	97022-002B	97028-002B
Antonio Zoli	1900	67022-0089	77022-0089	87022-0089	97022-0089	97028-0089
Benelli	ARGO	67022-0076	77022-0076	87022-0076	97022-0076	97028-0076
Beretta	689 gold sable / silver sable 2	67022-0099	77022-0099	87022-0099	97022-0099	97028-0099
Brünnner CZ	Prisma 16,0 mm	67022-0061	77022-0061	87022-0061	97022-0061	97028-0061
	Prisma 19,5 mm	67022-0062	77022-0062	87022-0062	97022-0062	97028-0062
Chapuis	Express	67022-0029	77022-0029	87022-0029	97022-0029	97028-0029
Fair / Rizzini	Express	67022-0091	77022-0091	87022-0091	97022-0091	97028-0091
FN Browning	A-Bolt	67022-0020	77022-0020	87022-0020	97022-0020	97028-0020
	A-Bolt III	67022-002T	77022-002T	87022-002T	97022-002T	97028-002T
	A-Bolt WSSM	67022-001G	77022-001G	87022-001G	97022-001G	97028-001G
	BAR / BLR / CBL / Acera	67022-0003	77022-0003	87022-0003	97022-0003	97028-0003
	Eurobolt	67022-0078	77022-0078	87022-0078	97022-0078	97028-0078
	European	67022-0056	77022-0056	87022-0056	97022-0056	97028-0056
	Maral	67022-002J	77022-002J	87022-002J	97022-002J	97028-002J
	X-Bolt	67022-001P	77022-001P	87022-001P	97022-001P	97028-001P
Haenel	Jäger 10 (bis Serien-Nr. JX-000920)	67022-001W	77022-001W	87022-001W	97022-001W	97028-001W
	Jäger 10 (ab Serien-Nr. JX-000921)	67022-002C	77022-002C	87022-002C	97022-002C	97028-002C
	SLB 2000+	67022-002I	77022-002I	87022-002I	97022-002I	97028-002I
H&K	SLB 2000	67022-0008	77022-0008	87022-0008	97022-0008	97028-0008
Heym	SR 20	67022-0060	77022-0060	87022-0060	97022-0060	97028-0060
	SR 21	67022-0022	77022-0022	87022-0022	97022-0022	97028-0022
	SR 30	67022-0090	77022-0090	87022-0090	97022-0090	97028-0090
Howa	1500	67022-0059	77022-0059	87022-0059	97022-0059	97028-0059
Krico	600 / 700 / 900 / 902 Deluxe	67022-0006	77022-0006	87022-0006	97022-0006	97028-0006
Krieghoff	Semprio	67022-001C	77022-001C	87022-001C	97022-001C	97028-001C
Mauser	66	67022-0009	77022-0009	87022-0009	97022-0009	97028-0009
	M 94	67022-0094	77022-0094	87022-0094	97022-0094	97028-0094
	M 96	67022-0096	77022-0096	87022-0096	97022-0096	97028-0096
	M 96 (ab Serien-Nr. 12000) / M 97	67022-0097	77022-0097	87022-0097	97022-0097	97028-0097
	K 98 (und Nachbauten)	67022-0010	77022-0010	87022-0010	97022-0010	97028-0010
	M 12	67022-002L	77022-002L	87022-002L	97022-002L	97028-002L
Merkel	SR1	67022-0098	77022-0098	87022-0098	97022-0098	97028-0098
	SR1 Basic	67022-002D	77022-002D	87022-002D	97022-002D	97028-002D
Remington	700 (Gewinde UNS 6-48)	67022-0012	77022-0012	87022-0012	97022-0012	97028-0012
	700 (Gewinde UNS 8-40)	67022-001N	77022-001N	87022-001N	97022-001N	97028-001N
	783	67022-0025	77022-0025	87022-0025	97022-0025	97028-0025
	7400 / 7600 / 750	67022-0013	77022-0013	87022-0013	97022-0013	97028-0013
	Seven	67022-0019	77022-0019	87022-0019	97022-0019	97028-0019
RWS-Rößler	Titan 3 / Titan 6 / Titan α	67022-0092	77022-0092	87022-0092	97022-0092	97028-0092
	Titan 16	67022-002G	77022-002G	87022-002G	97022-002G	97028-002G
Sabatti	Express	67022-001K	77022-001K	87022-001K	97022-001K	97028-001K
Sako	konisches Prisma / tapered dovetail	67022-0053	77022-0053	87022-0053	97022-0053	97028-0053
Sauer	80 / 90 / 92	67022-0015	77022-0015	87022-0015	97022-0015	97028-0015
	101	67022-002K	77022-002K	87022-002K	97022-002K	97028-002K
	200	67022-0016	77022-0016	87022-0016	97022-0016	97028-0016
	202	67022-0080	77022-0080	87022-0080	97022-0080	97028-0080
Savage	ebene Hülsenbrücke / flat Top	67022-0035	77022-0035	87022-0035	97022-0035	97028-0035
	gerundete Hülsenbrücke / rounded Top	67022-0093	77022-0093	87022-0093	97022-0093	97028-0093
Steyr-Mannlicher	Luxus (siehe Katalog auf Seite 61)					
	SBS-96	67022-0087	77022-0087	87022-0087	97022-0087	97028-0087
	SBS-96 Export/Pro Hunter/Classic/SM12/CLII	67022-0088	77022-0088	87022-0088	97022-0088	97028-0088
	Mannlicher-Schönauer GK	67022-0038	77022-0038		97022-0038	97028-0038
Swiss Arms	SHR-970 (Bohrungsabstand 21,9 mm)	67022-0040	77022-0040	87022-0040	97022-0040	97028-0040
Tikka	T3	67022-0081	77022-0081	87022-0081	97022-0081	97028-0081
Verney-Carron	Impact NT / Plus	67022-0047	77022-0047	87022-0047	97022-0047	97028-0047
Voere	LBW	67022-0055	77022-0055		97022-0055	97028-0055
Weatherby	Mark V / 300 / Vanguard	67022-0023	77022-0023	87022-0023	97022-0023	97028-0023
Winchester	70 short / long action	67022-0024	77022-0024	87022-0024	97022-0024	97028-0024
	70 Magnum (Baujahr nach 1964)	67022-0025	77022-0025	87022-0025	97022-0025	97028-0025
	70 WSM	67022-0011	77022-0011	87022-0011	97022-0011	97028-0011
	70 WSSM	67022-0069	77022-0069	87022-0069	97022-0069	97028-0069
	SXR Vulcan	67022-001J	77022-001J	87022-001J	97022-001J	97028-001J
Zastava	70	67022-0001	77022-0001	87022-0001	97022-0001	97028-0001

Swing mounts with 70° dovetail attachments / Montages pivotants avec 70° prisme

- 70° Aufnahmeprisma
- Verlängerung 26 mm
- Bauhöhe: 18,5 mm
- Prismenbreite 22 mm

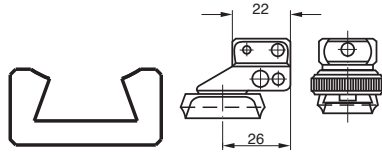

wahlweise mit folgenden ERAMATIC-Verschlüssen lieferbar:

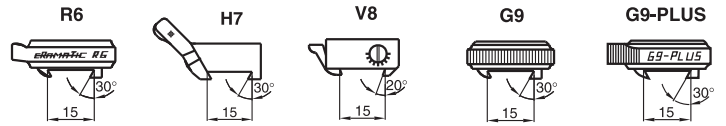

Anschütz	1780 / 1781	67022-262B	77022-262B	87022-262B	97022-262B	97028-262B
Antonio Zoli	1900	67022-2689	77022-2689	87022-2689	97022-2689	97028-2689
Benelli	ARGO	67022-2676	77022-2676	87022-2676	97022-2676	97028-2676
Beretta	689 gold sable / silver sable 2	67022-2699	77022-2699	87022-2699	97022-2699	97028-2699
Brünnner CZ	Prisma 16,0 mm	67022-2661	77022-2661	87022-2661	97022-2661	97028-2661
	Prisma 19,5 mm	67022-2662	77022-2662	87022-2662	97022-2662	97028-2662
Chapuis	Express	67022-2629	77022-2629	87022-2629	97022-2629	97028-2629
Fair / Rizzini	Express	67022-2691	77022-2691	87022-2691	97022-2691	97028-2691
FN Browning	A-Bolt	67022-2620	77022-2620	87022-2620	97022-2620	97028-2620
	A-Bolt III	67022-262T	77022-262T	87022-262T	97022-262T	97028-262T
	A-Bolt WSSM	67022-261G	77022-261G	87022-261G	97022-261G	97028-261G
	BAR / BLR / CBL / Acera	67022-2603	77022-2603	87022-2603	97022-2603	97028-2603
	Eurobolt	67022-2678	77022-2678	87022-2678	97022-2678	97028-2678
	European	67022-2656	77022-2656	87022-2656	97022-2656	97028-2656
	Maral	67022-262J	77022-262J	87022-262J	97022-262J	97028-262J
	X-Bolt	67022-261P	77022-261P	87022-261P	97022-261P	97028-261P
Haenel	Jäger 10 (bis Serien-Nr. JX-000920)	67022-261W	77022-261W	87022-261W	97022-261W	97028-261W
	Jäger 10 (ab Serien-Nr. JX-000921)	67022-262C	77022-262C	87022-262C	97022-262C	97028-262C
	SLB 2000+	67022-262I	77022-262I	87022-262I	97022-262I	97028-262I
H&K	SLB 2000	67022-2608	77022-2608	87022-2608	97022-2608	97028-2608
Heym	SR 20	67022-2660	77022-2660	87022-2660	97022-2660	97028-2660
	SR 21	67022-2622	77022-2622	87022-2622	97022-2622	97028-2622
	SR 30	67022-2690	77022-2690	87022-2690	97022-2690	97028-2690
Howa	1500	67022-2659	77022-2659	87022-2659	97022-2659	97028-2659
Krico	600 / 700 / 900 / 902 Deluxe	67022-2606	77022-2606	87022-2606	97022-2606	97028-2606
Krieghoff	Semprio	67022-261C	77022-261C	87022-261C	97022-261C	97028-261C
Mauser	66	67022-2609	77022-2609	87022-2609	97022-2609	97028-2609
	M 94	67022-2694	77022-2694	87022-2694	97022-2694	97028-2694
	M 96	67022-2696	77022-2696	87022-2696	97022-2696	97028-2696
	M 96 (ab Serien-Nr. 12000) / M 97	67022-2697	77022-2697	87022-2697	97022-2697	97028-2697
	K 98 (und Nachbauten)	67022-2610	77022-2610	87022-2610	97022-2610	97028-2610
	M 12	67022-262L	77022-262L	87022-262L	97022-262L	97028-262L
Merkel	SR1	67022-2698	77022-2698	87022-2698	97022-2698	97028-2698
	SR1 Basic	67022-262D	77022-262D	87022-262D	97022-262D	97028-262D
Remington	700 (Gewinde UNS 6-48)	67022-2612	77022-2612	87022-2612	97022-2612	97028-2612
	700 (Gewinde UNS 8-40)	67022-261N	77022-261N	87022-261N	97022-261N	97028-261N
	783	67022-2625	77022-2625	87022-2625	97022-2625	97028-2625
	7400 / 7600 / 750	67022-2613	77022-2613	87022-2613	97022-2613	97028-2613
	Seven	67022-2619	77022-2619	87022-2619	97022-2619	97028-2619
RWS-Rößler	Titan 3 / Titan 6 / Titan α	67022-2692	77022-2692	87022-2692	97022-2692	97028-2692
	Titan 16	67022-262G	77022-262G	87022-262G	97022-262G	97028-262G
Sabatti	Express	67022-261K	77022-261K	87022-261K	97022-261K	97028-261K
Sako	konisches Prisma / tapered dovetail	67022-2653	77022-2653	87022-2653	97022-2653	97028-2653
Sauer	80 / 90 / 92	67022-2615	77022-2615	87022-2615	97022-2615	97028-2615
	101	67022-262K	77022-262K	87022-262K	97022-262K	97028-262K
	200	67022-2616	77022-2616	87022-2616	97022-2616	97028-2616
	202	67022-2680	77022-2680	87022-2680	97022-2680	97028-2680
Savage	ebene Hülsenbrücke / flat Top	67022-2635	77022-2635	87022-2635	97022-2635	97028-2635
	gerundete Hülsenbrücke / rounded Top	67022-2693	77022-2693	87022-2693	97022-2693	97028-2693
Steyr-Mannlicher	Luxus (siehe Katalog auf Seite 61)					
	SBS-96	67022-2687	77022-2687	87022-2687	97022-2687	97028-2687
	SBS-96 Export/Pro Hunter/Classic/SM12/CLII	67022-2688	77022-2688	87022-2688	97022-2688	97028-2688
	Mannlicher-Schönauer GK	67022-2638	77022-2638		97022-2638	97028-2638
Swiss Arms	SHR-970 (Bohrungsabstand 21,9 mm)	67022-2640	77022-2640	87022-2640	97022-2640	97028-2640
Tikka	T3	67022-2681	77022-2681	87022-2681	97022-2681	97028-2681
Verney-Carron	Impact NT / Plus	67022-2647	77022-2647	87022-2647	97022-2647	97028-2647
Voerey	LBW	67022-2655	77022-2655		97022-2655	97028-2655
Weatherby	Mark V / 300 / Vanguard	67022-2623	77022-2623	87022-2623	97022-2623	97028-2623
Winchester	70 short / long action	67022-2624	77022-2624	87022-2624	97022-2624	97028-2624
	70 Magnum (Baujahr nach 1964)	67022-2625	77022-2625	87022-2625	97022-2625	97028-2625
	70 WSM	67022-2611	77022-2611	87022-2611	97022-2611	97028-2611
	70 WSSM	67022-2669	77022-2669	87022-2669	97022-2669	97028-2669
	SXR Vulcan	67022-261J	77022-261J	87022-261J	97022-261J	97028-261J
Zastava	70	67022-2601	77022-2601	87022-2601	97022-2601	97028-2601

Swing mounts with 70° dovetail attachments / Montages pivotants avec 70° prisme

- 70° Aufnahmeprisma
- Verlängerung 31 mm
- Bauhöhe: 18,5 mm
- Prismenbreite 22 mm

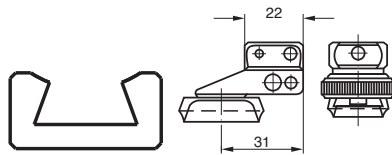

wahlweise mit folgenden ERAMATIC-Verschlüssen lieferbar:

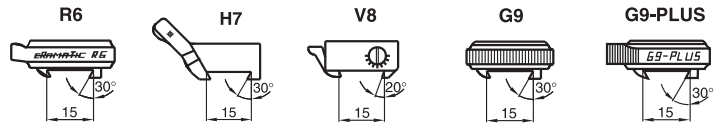

Anschütz	1780 / 1781	67022-312B	77022-312B	87022-312B	97022-312B	97028-312B
Antonio Zoli	1900	67022-3189	77022-3189	87022-3189	97022-3189	97028-3189
Benelli	ARGO	67022-3176	77022-3176	87022-3176	97022-3176	97028-3176
Beretta	689 gold sable / silver sable 2	67022-3199	77022-3199	87022-3199	97022-3199	97028-3199
Brünnner CZ	Prisma 16,0 mm	67022-3161	77022-3161	87022-3161	97022-3161	97028-3161
	Prisma 19,5 mm	67022-3162	77022-3162	87022-3162	97022-3162	97028-3162
Chapuis	Express	67022-3129	77022-3129	87022-3129	97022-3129	97028-3129
Fair / Rizzini	Express	67022-3191	77022-3191	87022-3191	97022-3191	97028-3191
FN Browning	A-Bolt	67022-3120	77022-3120	87022-3120	97022-3120	97028-3120
	A-Bolt III	67022-312T	77022-312T	87022-312T	97022-312T	97028-312T
	A-Bolt WSSM	67022-311G	77022-311G	87022-311G	97022-311G	97028-311G
	BAR / BLR / CBL / Acera	67022-3103	77022-3103	87022-3103	97022-3103	97028-3103
	Eurobolt	67022-3178	77022-3178	87022-3178	97022-3178	97028-3178
	European	67022-3156	77022-3156	87022-3156	97022-3156	97028-3156
	Maral	67022-312J	77022-312J	87022-312J	97022-312J	97028-312J
	X-Bolt	67022-311P	77022-311P	87022-311P	97022-311P	97028-311P
Haenel	Jäger 10 (bis Serien-Nr. JX-000920)	67022-311W	77022-311W	87022-311W	97022-311W	97028-311W
	Jäger 10 (ab Serien-Nr. JX-000921)	67022-312C	77022-312C	87022-312C	97022-312C	97028-312C
	SLB 2000+	67022-312I	77022-312I	87022-312I	97022-312I	97028-312I
H&K	SLB 2000	67022-3108	77022-3108	87022-3108	97022-3108	97028-3108
Heym	SR 20	67022-3160	77022-3160	87022-3160	97022-3160	97028-3160
	SR 21	67022-3122	77022-3122	87022-3122	97022-3122	97028-3122
	SR 30	67022-3190	77022-3190	87022-3190	97022-3190	97028-3190
Howa	1500	67022-3159	77022-3159	87022-3159	97022-3159	97028-3159
Krico	600 / 700 / 900 / 902 Deluxe	67022-3106	77022-3106	87022-3106	97022-3106	97028-3106
Krieghoff	Semprio	67022-311C	77022-311C	87022-311C	97022-311C	97028-311C
Mauser	66	67022-3109	77022-3109	87022-3109	97022-3109	97028-3109
	M 94	67022-3194	77022-3194	87022-3194	97022-3194	97028-3194
	M 96	67022-3196	77022-3196	87022-3196	97022-3196	97028-3196
	M 96 (ab Serien-Nr. 12000) / M 97	67022-3197	77022-3197	87022-3197	97022-3197	97028-3197
	K 98 (und Nachbauten)	67022-3110	77022-3110	87022-3110	97022-3110	97028-3110
	M 12	67022-312L	77022-312L	87022-312L	97022-312L	97028-312L
Merkel	SR1	67022-3198	77022-3198	87022-3198	97022-3198	97028-3198
	SR1 Basic	67022-312D	77022-312D	87022-312D	97022-312D	97028-312D
Remington	700 (Gewinde UNS 6-48)	67022-3112	77022-3112	87022-3112	97022-3112	97028-3112
	700 (Gewinde UNS 8-40)	67022-311N	77022-311N	87022-311N	97022-311N	97028-311N
	783	67022-3125	77022-3125	87022-3125	97022-3125	97028-3125
	7400 / 7600 / 750	67022-3113	77022-3113	87022-3113	97022-3113	97028-3113
	Seven	67022-3119	77022-3119	87022-3119	97022-3119	97028-3119
RWS-Rößler	Titan 3 / Titan 6 / Titan α	67022-3192	77022-3192	87022-3192	97022-3192	97028-3192
	Titan 16	67022-312G	77022-312G	87022-312G	97022-312G	97028-312G
Sabatti	Express	67022-311K	77022-311K	87022-311K	97022-311K	97028-311K
Sako	konisches Prisma / tapered dovetail	67022-3153	77022-3153	87022-3153	97022-3153	97028-3153
Sauer	80 / 90 / 92	67022-3115	77022-3115	87022-3115	97022-3115	97028-3115
	101	67022-312K	77022-312K	87022-312K	97022-312K	97028-312K
	200	67022-3116	77022-3116	87022-3116	97022-3116	97028-3116
	202	67022-3180	77022-3180	87022-3180	97022-3180	97028-3180
Savage	ebene Hülsenbrücke / flat Top	67022-3135	77022-3135	87022-3135	97022-3135	97028-3135
	gerundete Hülsenbrücke / rounded Top	67022-3193	77022-3193	87022-3193	97022-3193	97028-3193
Steyr-Mannlicher	Luxus (siehe Katalog auf Seite 61)					
	SBS-96	67022-3187	77022-3187	87022-3187	97022-3187	97028-3187
	SBS-96 Export/Pro Hunter/Classic/SM12/CLII	67022-3188	77022-3188	87022-3188	97022-3188	97028-3188
	Mannlicher-Schönauer GK	67022-3138	77022-3138		97022-3138	97028-3138
Swiss Arms	SHR-970 (Bohrungsabstand 21,9 mm)	67022-3140	77022-3140	87022-3140	97022-3140	97028-3140
Tikka	T3	67022-3181	77022-3181	87022-3181	97022-3181	97028-3181
Verney-Carron	Impact NT / Plus	67022-3147	77022-3147	87022-3147	97022-3147	97028-3147
Voere	LBW	67022-3155	77022-3155		97022-3155	97028-3155
Weatherby	Mark V / 300 / Vanguard	67022-3123	77022-3123	87022-3123	97022-3123	97028-3123
Winchester	70 short / long action	67022-3124	77022-3124	87022-3124	97022-3124	97028-3124
	70 Magnum (Baujahr nach 1964)	67022-3125	77022-3125	87022-3125	97022-3125	97028-3125
	70 WSM	67022-3111	77022-3111	87022-3111	97022-3111	97028-3111
	70 WSSM	67022-3169	77022-3169	87022-3169	97022-3169	97028-3169
	SXR Vulcan	67022-311J	77022-311J	87022-311J	97022-311J	97028-311J
Zastava	70	67022-3101	77022-3101	87022-3101	97022-3101	97028-3101

Swing mounts with 70° dovetail attachments / Montages pivotants avec 70° prisme

wahlweise mit folgenden ERAMATIC-Verschlüssen lieferbar:

- 70° Aufnahmeprisma
- Verlängerung 44 mm
- Bauhöhe: 18,5 mm
- Prismenbreite 22 mm

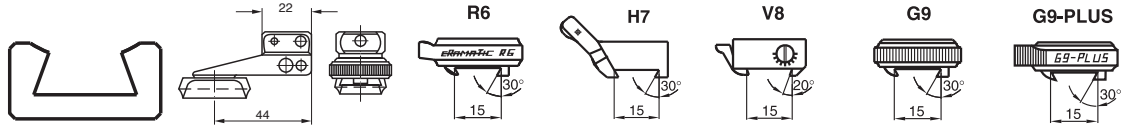

Anschütz	1780 / 1781	67022-442B	77022-442B	87022-442B	97022-442B	97028-442B
Antonio Zoli	1900	67022-4489	77022-4489	87022-4489	97022-4489	97028-4489
Benelli	ARGO	67022-4476	77022-4476	87022-4476	97022-4476	97028-4476
Beretta	689 gold sable / silver sable 2	67022-4499	77022-4499	87022-4499	97022-4499	97028-4499
Brügger	Prisma 16,0 mm	67022-4461	77022-4461	87022-4461	97022-4461	97028-4461
	Prisma 19,5 mm	67022-4462	77022-4462	87022-4462	97022-4462	97028-4462
Chapuis	Express	67022-4429	77022-4429	87022-4429	97022-4429	97028-4429
Fair / Rizzini	Express	67022-4491	77022-4491	87022-4491	97022-4491	97028-4491
FN Browning	A-Bolt	67022-4420	77022-4420	87022-4420	97022-4420	97028-4420
	A-Bolt III	67022-442T	77022-442T	87022-442T	97022-442T	97028-442T
	A-Bolt WSSM	67022-441G	77022-441G	87022-441G	97022-441G	97028-441G
	BAR / BLR / CBL / Acera	67022-4403	77022-4403	87022-4403	97022-4403	97028-4403
	Eurobolt	67022-4478	77022-4478	87022-4478	97022-4478	97028-4478
	European	67022-4456	77022-4456	87022-4456	97022-4456	97028-4456
	Maral	67022-442J	77022-442J	87022-442J	97022-442J	97028-442J
	X-Bolt	67022-441P	77022-441P	87022-441P	97022-441P	97028-441P
Haenel	Jäger 10 (bis Serien-Nr. JX-000920)	67022-441W	77022-441W	87022-441W	97022-441W	97028-441W
	Jäger 10 (ab Serien-Nr. JX-000921)	67022-442C	77022-442C	87022-442C	97022-442C	97028-442C
	SLB 2000+	67022-442I	77022-442I	87022-442I	97022-442I	97028-442I
H&K	SLB 2000	67022-4408	77022-4408	87022-4408	97022-4408	97028-4408
Heym	SR 20	67022-4460	77022-4460	87022-4460	97022-4460	97028-4460
	SR 21	67022-4422	77022-4422	87022-4422	97022-4422	97028-4422
	SR 30	67022-4490	77022-4490	87022-4490	97022-4490	97028-4490
Howa	1500	67022-4459	77022-4459	87022-4459	97022-4459	97028-4459
Krico	600 / 700 / 900 / 902 Deluxe	67022-4406	77022-4406	87022-4406	97022-4406	97028-4406
Krieghoff	Semprio	67022-441C	77022-441C	87022-441C	97022-441C	97028-441C
Mauser	66	67022-4409	77022-4409	87022-4409	97022-4409	97028-4409
	M 94	67022-4494	77022-4494	87022-4494	97022-4494	97028-4494
	M 96	67022-4496	77022-4496	87022-4496	97022-4496	97028-4496
	M 96 (ab Serien-Nr. 12000) / M 97	67022-4497	77022-4497	87022-4497	97022-4497	97028-4497
	K 98 (und Nachbauten)	67022-4410	77022-4410	87022-4410	97022-4410	97028-4410
	M 12	67022-442L	77022-442L	87022-442L	97022-442L	97028-442L
Merkel	SR1	67022-4498	77022-4498	87022-4498	97022-4498	97028-4498
	SR1 Basic	67022-442D	77022-442D	87022-442D	97022-442D	97028-442D
Remington	700 (Gewinde UNS 6-48)	67022-4412	77022-4412	87022-4412	97022-4412	97028-4412
	700 (Gewinde UNS 8-40)	67022-441N	77022-441N	87022-441N	97022-441N	97028-441N
	783	67022-4425	77022-4425	87022-4425	97022-4425	97028-4425
	7400 / 7600 / 750	67022-4413	77022-4413	87022-4413	97022-4413	97028-4413
	Seven	67022-4419	77022-4419	87022-4419	97022-4419	97028-4419
RWS-Rößler	Titan 3 / Titan 6 / Titan α	67022-4492	77022-4492	87022-4492	97022-4492	97028-4492
	Titan 16	67022-442G	77022-442G	87022-442G	97022-442G	97028-442G
Sabatti	Express	67022-441K	77022-441K	87022-441K	97022-441K	97028-441K
Sako	konisches Prisma / tapered dovetail	67022-4453	77022-4453	87022-4453	97022-4453	97028-4453
Sauer	80 / 90 / 92	67022-4415	77022-4415	87022-4415	97022-4415	97028-4415
	101	67022-442K	77022-442K	87022-442K	97022-442K	97028-442K
	200	67022-4416	77022-4416	87022-4416	97022-4416	97028-4416
	202	67022-4480	77022-4480	87022-4480	97022-4480	97028-4480
Savage	ebene Hülsenbrücke / flat Top	67022-4435	77022-4435	87022-4435	97022-4435	97028-4435
	gerundete Hülsenbrücke / rounded Top	67022-4493	77022-4493	87022-4493	97022-4493	97028-4493
Steyr-Mannlicher	Luxus (siehe Katalog auf Seite 61)					
	SBS-96	67022-4487	77022-4487	87022-4487	97022-4487	97028-4487
	SBS-96 Export/Pro Hunter/Classic/SM12/CLII	67022-4488	77022-4488	87022-4488	97022-4488	97028-4488
	Mannlicher-Schönauer GK	67022-4438	77022-4438		97022-4438	97028-4438
Swiss Arms	SHR-970 (Bohrungsabstand 21,9 mm)	67022-4440	77022-4440	87022-4440	97022-4440	97028-4440
Tikka	T3	67022-4481	77022-4481	87022-4481	97022-4481	97028-4481
Verney-Carron	Impact NT / Plus	67022-4447	77022-4447	87022-4447	97022-4447	97028-4447
Voere	LBW	67022-4455	77022-4455		97022-4455	97028-4455
Weatherby	Mark V / 300 / Vanguard	67022-4423	77022-4423	87022-4423	97022-4423	97028-4423
Winchester	70 short / long action	67022-4424	77022-4424	87022-4424	97022-4424	97028-4424
	70 Magnum (Baujahr nach 1964)	67022-4425	77022-4425	87022-4425	97022-4425	97028-4425
	70 WSM	67022-4411	77022-4411	87022-4411	97022-4411	97028-4411
	70 WSSM	67022-4469	77022-4469	87022-4469	97022-4469	97028-4469
	SXR Vulcan	67022-441J	77022-441J	87022-441J	97022-441J	97028-441J
Zastava	70	67022-4401	77022-4401	87022-4401	97022-4401	97028-4401

Swing mounts with 70° dovetail attachments / Montages pivotants avec 70° prisme

wahlweise mit folgenden ERAMATIC-Verschlüssen lieferbar:

- 70° Aufnahmeprisma
- Verlängerung 56 mm
- Bauhöhe: 18,5 mm
- Prismenbreite 22 mm

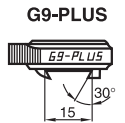
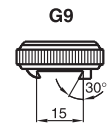
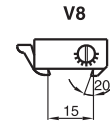
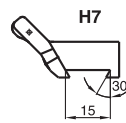
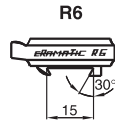
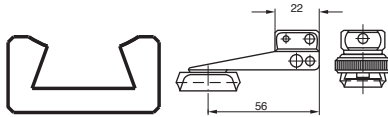

Anschütz	1780 / 1781	67022-562B	77022-562B	87022-562B	97022-562B	97028-562B
Antonio Zoli	1900	67022-5689	77022-5689	87022-5689	97022-5689	97028-5689
Benelli	ARGO	67022-5676	77022-5676	87022-5676	97022-5676	97028-5676
Beretta	689 gold sable / silver sable 2	67022-5699	77022-5699	87022-5699	97022-5699	97028-5699
Brünner CZ	Prisma 16,0 mm	67022-5661	77022-5661	87022-5661	97022-5661	97028-5661
	Prisma 19,5 mm	67022-5662	77022-5662	87022-5662	97022-5662	97028-5662
Chapuis	Express	67022-5629	77022-5629	87022-5629	97022-5629	97028-5629
Fair / Rizzini	Express	67022-5691	77022-5691	87022-5691	97022-5691	97028-5691
FN Browning	A-Bolt	67022-5620	77022-5620	87022-5620	97022-5620	97028-5620
	A-Bolt III	67022-562T	77022-562T	87022-562T	97022-562T	97028-562T
	A-Bolt WSSM	67022-561G	77022-561G	87022-561G	97022-561G	97028-561G
	BAR / BLR / CBL / Acera	67022-5603	77022-5603	87022-5603	97022-5603	97028-5603
	Eurobolt	67022-5678	77022-5678	87022-5678	97022-5678	97028-5678
	European	67022-5656	77022-5656	87022-5656	97022-5656	97028-5656
	Maral	67022-562J	77022-562J	87022-562J	97022-562J	97028-562J
	X-Bolt	67022-561P	77022-561P	87022-561P	97022-561P	97028-561P
Haenel	Jäger 10 (bis Serien-Nr. JX-000920)	67022-561W	77022-561W	87022-561W	97022-561W	97028-561W
	Jäger 10 (ab Serien-Nr. JX-000921)	67022-562C	77022-562C	87022-562C	97022-562C	97028-562C
	SLB 2000+	67022-562I	77022-562I	87022-562I	97022-562I	97028-562I
H&K	SLB 2000	67022-5608	77022-5608	87022-5608	97022-5608	97028-5608
Heym	SR 20	67022-5660	77022-5660	87022-5660	97022-5660	97028-5660
	SR 21	67022-5622	77022-5622	87022-5622	97022-5622	97028-5622
	SR 30	67022-5690	77022-5690	87022-5690	97022-5690	97028-5690
Howa	1500	67022-5659	77022-5659	87022-5659	97022-5659	97028-5659
Krico	600 / 700 / 900 / 902 Deluxe	67022-5606	77022-5606	87022-5606	97022-5606	97028-5606
Krieghoff	Semprio	67022-561C	77022-561C	87022-561C	97022-561C	97028-561C
Mauser	66	67022-5609	77022-5609	87022-5609	97022-5609	97028-5609
	M 94	67022-5694	77022-5694	87022-5694	97022-5694	97028-5694
	M 96	67022-5696	77022-5696	87022-5696	97022-5696	97028-5696
	M 96 (ab Serien-Nr. 12000) / M 97	67022-5697	77022-5697	87022-5697	97022-5697	97028-5697
	K 98 (und Nachbauten)	67022-5610	77022-5610	87022-5610	97022-5610	97028-5610
	M 12	67022-562L	77022-562L	87022-562L	97022-562L	97028-562L
Merkel	SR1	67022-5698	77022-5698	87022-5698	97022-5698	97028-5698
	SR1 Basic	67022-562D	77022-562D	87022-562D	97022-562D	97028-562D
Remington	700 (Gewinde UNS 6-48)	67022-5612	77022-5612	87022-5612	97022-5612	97028-5612
	700 (Gewinde UNS 8-40)	67022-561N	77022-561N	87022-561N	97022-561N	97028-561N
	783	67022-5625	77022-5625	87022-5625	97022-5625	97028-5625
	7400 / 7600 / 750	67022-5613	77022-5613	87022-5613	97022-5613	97028-5613
	Seven	67022-5619	77022-5619	87022-5619	97022-5619	97028-5619
RWS-Rößler	Titan 3 / Titan 6 / Titan α	67022-5692	77022-5692	87022-5692	97022-5692	97028-5692
	Titan 16	67022-562G	77022-562G	87022-562G	97022-562G	97028-562G
Sabatti	Express	67022-561K	77022-561K	87022-561K	97022-561K	97028-561K
Sako	konisches Prisma / tapered dovetail	67022-5653	77022-5653	87022-5653	97022-5653	97028-5653
Sauer	80 / 90 / 92	67022-5615	77022-5615	87022-5615	97022-5615	97028-5615
	101	67022-562K	77022-562K	87022-562K	97022-562K	97028-562K
	200	67022-5616	77022-5616	87022-5616	97022-5616	97028-5616
	202	67022-5680	77022-5680	87022-5680	97022-5680	97028-5680
Savage	ebene Hülsenbrücke / flat Top	67022-5635	77022-5635	87022-5635	97022-5635	97028-5635
	gerundete Hülsenbrücke / rounded Top	67022-5693	77022-5693	87022-5693	97022-5693	97028-5693
Steyr-Mannlicher	Luxus (siehe Katalog auf Seite 61)					
	SBS-96	67022-5687	77022-5687	87022-5687	97022-5687	97028-5687
	SBS-96 Export/Pro Hunter/Classic/SM12/CLII	67022-5688	77022-5688	87022-5688	97022-5688	97028-5688
	Mannlicher-Schönauer GK	67022-5638	77022-5638		97022-5638	97028-5638
Swiss Arms	SHR-970 (Bohrungsabstand 21,9 mm)	67022-5640	77022-5640	87022-5640	97022-5640	97028-5640
Tikka	T3	67022-5681	77022-5681	87022-5681	97022-5681	97028-5681
Verney-Carron	Impact NT / Plus	67022-5647	77022-5647	87022-5647	97022-5647	97028-5647
Voere	LBW	67022-5655	77022-5655		97022-5655	97028-5655
Weatherby	Mark V / 300 / Vanguard	67022-5623	77022-5623	87022-5623	97022-5623	97028-5623
Winchester	70 short / long action	67022-5624	77022-5624	87022-5624	97022-5624	97028-5624
	70 Magnum (Baujahr nach 1964)	67022-5625	77022-5625	87022-5625	97022-5625	97028-5625
	70 WSM	67022-5611	77022-5611	87022-5611	97022-5611	97028-5611
	70 WSSM	67022-5669	77022-5669	87022-5669	97022-5669	97028-5669
	SXR Vulcan	67022-561J	77022-561J	87022-561J	97022-561J	97028-561J
Zastava	70	67022-5601	77022-5601	87022-5601	97022-5601	97028-5601

Swing mounts with 45° dovetail attachments / Montages pivotants avec 45° prisme

wahlweise mit folgenden ERAMATIC-Verschlüssen lieferbar:

- 45° Aufnahmeprisma
- kurze Ausführung
- Bauhöhe: 19,0 mm
- Prismenbreite 35 mm

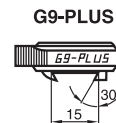
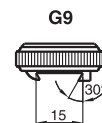
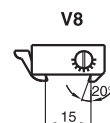
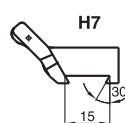
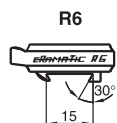
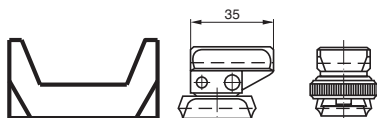

Anschütz	1780 / 1781	64535-002B	74535-002B	84535-002B	94535-002B	94538-002B
Antonio Zoli	1900	64535-0089	74535-0089	84535-0089	94535-0089	94538-0089
Benelli	ARGO	64535-0076	74535-0076	84535-0076	94535-0076	94538-0076
Beretta	689 gold sable / silver sable 2	64535-0099	74535-0099	84535-0099	94535-0099	94538-0099
Brünnner CZ	Prisma 16,0 mm	64535-0061	74535-0061	84535-0061	94535-0061	94538-0061
	Prisma 19,5 mm	64535-0062	74535-0062	84535-0062	94535-0062	94538-0062
Chapuis	Express	64535-0029	74535-0029	84535-0029	94535-0029	94538-0029
Fair / Rizzini	Express	64535-0091	74535-0091	84535-0091	94535-0091	94538-0091
FN Browning	A-Bolt	64535-0020	74535-0020	84535-0020	94535-0020	94538-0020
	A-Bolt III	64535-002T	74535-002T	84535-002T	94535-002T	94538-002T
	A-Bolt WSSM	64535-001G	74535-001G	84535-001G	94535-001G	94538-001G
	BAR / BLR / CBL / Acera	64535-0003	74535-0003	84535-0003	94535-0003	94538-0003
	Eurobolt	64535-0078	74535-0078	84535-0078	94535-0078	94538-0078
	European	64535-0056	74535-0056	84535-0056	94535-0056	94538-0056
	Maral	64535-002J	74535-002J	84535-002J	94535-002J	94538-002J
	X-Bolt	64535-001P	74535-001P	84535-001P	94535-001P	94538-001P
Haenel	Jäger 10 (bis Serien-Nr. JX-000920)	64535-001W	74535-001W	84535-001W	94535-001W	94538-001W
	Jäger 10 (ab Serien-Nr. JX-000921)	64535-002C	74535-002C	84535-002C	94535-002C	94538-002C
	SLB 2000+	64535-002I	74535-002I	84535-002I	94535-002I	94538-002I
H&K	SLB 2000	64535-0008	74535-0008	84535-0008	94535-0008	94538-0008
Heym	SR 20	64535-0060	74535-0060	84535-0060	94535-0060	94538-0060
	SR 21	64535-0022	74535-0022	84535-0022	94535-0022	94538-0022
	SR 30	64535-0090	74535-0090	84535-0090	94535-0090	94538-0090
Howa	1500	64535-0059	74535-0059	84535-0059	94535-0059	94538-0059
Krico	600 / 700 / 900 / 902 Deluxe	64535-0006	74535-0006	84535-0006	94535-0006	94538-0006
Krieghoff	Semprio	64535-001C	74535-001C	84535-001C	94535-001C	94538-001C
Mauser	66	64535-0009	74535-0009	84535-0009	94535-0009	94538-0009
	M 94	64535-0094	74535-0094	84535-0094	94535-0094	94538-0094
	M 96	64535-0096	74535-0096	84535-0096	94535-0096	94538-0096
	M 96 (ab Serien-Nr. 12000) / M 97	64535-0097	74535-0097	84535-0097	94535-0097	94538-0097
	K 98 (und Nachbauten)	64535-0010	74535-0010	84535-0010	94535-0010	94538-0010
	M 12	64535-002L	74535-002L	84535-002L	94535-002L	94538-002L
Merkel	SR1	64535-0098	74535-0098	84535-0098	94535-0098	94538-0098
	SR1 Basic	64535-002D	74535-002D	84535-002D	94535-002D	94538-002D
Remington	700 (Gewinde UNS 6-48)	64535-0012	74535-0012	84535-0012	94535-0012	94538-0012
	700 (Gewinde UNS 8-40)	64535-001N	74535-001N	84535-001N	94535-001N	94538-001N
	783	64535-0025	74535-0025	84535-0025	94535-0025	94538-0025
	7400 / 7600 / 750	64535-0013	74535-0013	84535-0013	94535-0013	94538-0013
	Seven	64535-0019	74535-0019	84535-0019	94535-0019	94538-0019
RWS-Rößler	Titan 3 / Titan 6 / Titan α	64535-0092	74535-0092	84535-0092	94535-0092	94538-0092
	Titan 16	64535-002G	74535-002G	84535-002G	94535-002G	94538-002G
Sabatti	Express	64535-001K	74535-001K	84535-001K	94535-001K	94538-001K
Sako	konisches Prisma / tapered dovetail	64535-0053	74535-0053	84535-0053	94535-0053	94538-0053
Sauer	80 / 90 / 92	64535-0015	74535-0015	84535-0015	94535-0015	94538-0015
	101	64535-002K	74535-002K	84535-002K	94535-002K	94538-002K
	200	64535-0016	74535-0016	84535-0016	94535-0016	94538-0016
	202	64535-0080	74535-0080	84535-0080	94535-0080	94538-0080
Savage	ebene Hülsenbrücke / flat Top	64535-0035	74535-0035	84535-0035	94535-0035	94538-0035
	gerundete Hülsenbrücke / rounded Top	64535-0093	74535-0093	84535-0093	94535-0093	94538-0093
Steyr-Mannlicher	Luxus (siehe Katalog auf Seite 61)					
	SBS-96	64535-0087	74535-0087	84535-0087	94535-0087	94538-0087
	SBS-96 Export/Pro Hunter/Classic/SM12/CLII	64535-0088	74535-0088	84535-0088	94535-0088	94538-0088
	Mannlicher-Schönauer GK	64535-0038	74535-0038	84535-0038	94535-0038	94538-0038
Swiss Arms	SHR-970 (Bohrungsabstand 21,9 mm)	64535-0040	74535-0040	84535-0040	94535-0040	94538-0040
Tikka	T3	64535-0081	74535-0081	84535-0081	94535-0081	94538-0081
Verney-Carron	Impact NT / Plus	64535-0047	74535-0047	84535-0047	94535-0047	94538-0047
Voere	LBW	64535-0055	74535-0055		94535-0055	94538-0055
Weatherby	Mark V / 300 / Vanguard	64535-0023	74535-0023	84535-0023	94535-0023	94538-0023
Winchester	70 short / long action	64535-0024	74535-0024	84535-0024	94535-0024	94538-0024
	70 Magnum (Baujahr nach 1964)	64535-0025	74535-0025	84535-0025	94535-0025	94538-0025
	70 WSM	64535-0011	74535-0011	84535-0011	94535-0011	94538-0011
	70 WSSM	64535-0069	74535-0069	84535-0069	94535-0069	94538-0069
	SXR Vulcan	64535-001J	74535-001J	84535-001J	94535-001J	94538-001J
Zastava	70	64535-0001	74535-0001	84535-0001	94535-0001	94538-0001

Swing mounts with 45° dovetail attachments / Montages pivotants avec 45° prisme

wahlweise mit folgenden ERAMATIC-Verschlüssen lieferbar:

- 45° Aufnahmeprisma
- Verlängerung 38 mm
- Bauhöhe: 19,0 mm
- Prismenbreite 35 mm

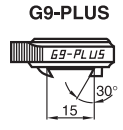
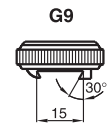
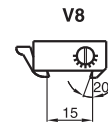
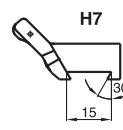
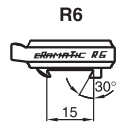
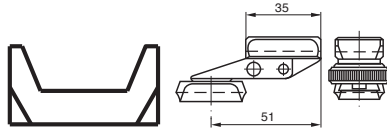

Anschütz	1780 / 1781	64535-382B	74535-382B	84535-382B	94535-382B	94538-382B
Antonio Zoli	1900	64535-3889	74535-3889	84535-3889	94535-3889	94538-3889
Benelli	ARGO	64535-3876	74535-3876	84535-3876	94535-3876	94538-3876
Beretta	689 gold sable / silver sable 2	64535-3899	74535-3899	84535-3899	94535-3899	94538-3899
Brünnner CZ	Prisma 16,0 mm	64535-3861	74535-3861	84535-3861	94535-3861	94538-3861
	Prisma 19,5 mm	64535-3862	74535-3862	84535-3862	94535-3862	94538-3862
Chapuis	Express	64535-3829	74535-3829	84535-3829	94535-3829	94538-3829
Fair / Rizzini	Express	64535-3891	74535-3891	84535-3891	94535-3891	94538-3891
FN Browning	A-Bolt	64535-3820	74535-3820	84535-3820	94535-3820	94538-3820
	A-Bolt III	64535-382T	74535-382T	84535-382T	94535-382T	94538-382T
	A-Bolt WSSM	64535-381G	74535-381G	84535-381G	94535-381G	94538-381G
	BAR / BLR / CBL / Acera	64535-3803	74535-3803	84535-3803	94535-3803	94538-3803
	Eurobolt	64535-3878	74535-3878	84535-3878	94535-3878	94538-3878
	European	64535-3856	74535-3856	84535-3856	94535-3856	94538-3856
	Maral	64535-382J	74535-382J	84535-382J	94535-382J	94538-382J
	X-Bolt	64535-381P	74535-381P	84535-381P	94535-381P	94538-381P
Haenel	Jäger 10 (bis Serien-Nr. JX-000920)	64535-381W	74535-381W	84535-381W	94535-381W	94538-381W
	Jäger 10 (ab Serien-Nr. JX-000921)	64535-382C	74535-382C	84535-382C	94535-382C	94538-382C
	SLB 2000+	64535-382I	74535-382I	84535-382I	94535-382I	94538-382I
H&K	SLB 2000	64535-3808	74535-3808	84535-3808	94535-3808	94538-3808
Heym	SR 20	64535-3860	74535-3860	84535-3860	94535-3860	94538-3860
	SR 21	64535-3822	74535-3822	84535-3822	94535-3822	94538-3822
	SR 30	64535-3890	74535-3890	84535-3890	94535-3890	94538-3890
Howa	1500	64535-3859	74535-3859	84535-3859	94535-3859	94538-3859
Krico	600 / 700 / 900 / 902 Deluxe	64535-3806	74535-3806	84535-3806	94535-3806	94538-3806
Krieghoff	Semprio	64535-381C	74535-381C	84535-381C	94535-381C	94538-381C
Mauser	66	64535-3809	74535-3809	84535-3809	94535-3809	94538-3809
	M 94	64535-3894	74535-3894	84535-3894	94535-3894	94538-3894
	M 96	64535-3896	74535-3896	84535-3896	94535-3896	94538-3896
	M 96 (ab Serien-Nr. 12000) / M 97	64535-3897	74535-3897	84535-3897	94535-3897	94538-3897
	K 98 (und Nachbauten)	64535-3810	74535-3810	84535-3810	94535-3810	94538-3810
	M 12	64535-382L	74535-382L	84535-382L	94535-382L	94538-382L
Merkel	SR1	64535-3898	74535-3898	84535-3898	94535-3898	94538-3898
	SR1 Basic	64535-382D	74535-382D	84535-382D	94535-382D	94538-382D
Remington	700 (Gewinde UNS 6-48)	64535-3812	74535-3812	84535-3812	94535-3812	94538-3812
	700 (Gewinde UNS 8-40)	64535-381N	74535-381N	84535-381N	94535-381N	94538-381N
	783	64535-3825	74535-3825	84535-3825	94535-3825	94538-3825
	7400 / 7600 / 750	64535-3813	74535-3813	84535-3813	94535-3813	94538-3813
	Seven	64535-3819	74535-3819	84535-3819	94535-3819	94538-3819
RWS-Rößler	Titan 3 / Titan 6 / Titan α	64535-3892	74535-3892	84535-3892	94535-3892	94538-3892
	Titan 16	64535-382G	74535-382G	84535-382G	94535-382G	94538-382G
Sabatti	Express	64535-381K	74535-381K	84535-381K	94535-381K	94538-381K
Sako	konisches Prisma / tapered dovetail	64535-3853	74535-3853	84535-3853	94535-3853	94538-3853
Sauer	80 / 90 / 92	64535-3815	74535-3815	84535-3815	94535-3815	94538-3815
	101	64535-382K	74535-382K	84535-382K	94535-382K	94538-382K
	200	64535-3816	74535-3816	84535-3816	94535-3816	94538-3816
	202	64535-3880	74535-3880	84535-3880	94535-3880	94538-3880
Savage	ebene Hülsenbrücke / flat Top	64535-3835	74535-3835	84535-3835	94535-3835	94538-3835
	gerundete Hülsenbrücke / rounded Top	64535-3893	74535-3893	84535-3893	94535-3893	94538-3893
Steyr-Mannlicher	Luxus (siehe Katalog auf Seite 61)					
	SBS-96	64535-3887	74535-3887	84535-3887	94535-3887	94538-3887
	SBS-96 Export/Pro Hunter/Classic/SM12/CLII	64535-3888	74535-3888	84535-3888	94535-3888	94538-3888
	Mannlicher-Schönauer GK	64535-3838	74535-3838		94535-3838	94538-3838
Swiss Arms	SHR-970 (Bohrungsabstand 21,9 mm)	64535-3840	74535-3840	84535-3840	94535-3840	94538-3840
Tikka	T3	64535-3881	74535-3881	84535-3881	94535-3881	94538-3881
Verney-Carron	Impact NT / Plus	64535-3847	74535-3847	84535-3847	94535-3847	94538-3847
Voere	LBW	64535-3855	74535-3855		94535-3855	94538-3855
Weatherby	Mark V / 300 / Vanguard	64535-3823	74535-3823	84535-3823	94535-3823	94538-3823
Winchester	70 short / long action	64535-3824	74535-3824	84535-3824	94535-3824	94538-3824
	70 Magnum (Baujahr nach 1964)	64535-3825	74535-3825	84535-3825	94535-3825	94538-3825
	70 WSM	64535-3811	74535-3811	84535-3811	94535-3811	94538-3811
	70 WSSM	64535-3869	74535-3869	84535-3869	94535-3869	94538-3869
	SXR Vulcan	64535-381J	74535-381J	84535-381J	94535-381J	94538-381J
Zastava	70	64535-3801	74535-3801	84535-3801	94535-3801	94538-3801

Swing mounts with 45° dovetail attachments / Montages pivotants avec 45° prisme

wahlweise mit folgenden ERAMATIC-Verschlüssen lieferbar:

- 45° Aufnahmeprisma
- Verlängerung 56 mm
- Bauhöhe: 19,0 mm
- Prismenbreite 35 mm

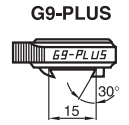
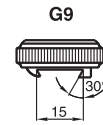
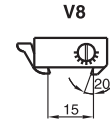
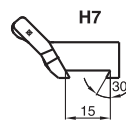
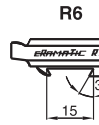
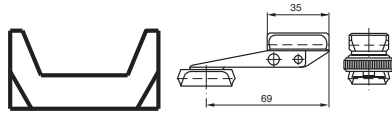

Anschütz	1780 / 1781	64535-562B	74535-562B	84535-562B	94535-562B	94538-562B
Antonio Zoli	1900	64535-5689	74535-5689	84535-5689	94535-5689	94538-5689
Benelli	ARGO	64535-5676	74535-5676	84535-5676	94535-5676	94538-5676
Beretta	689 gold sable / silver sable 2	64535-5699	74535-5699	84535-5699	94535-5699	94538-5699
Brügger CZ	Prisma 16,0 mm	64535-5661	74535-5661	84535-5661	94535-5661	94538-5661
	Prisma 19,5 mm	64535-5662	74535-5662	84535-5662	94535-5662	94538-5662
Chapuis	Express	64535-5629	74535-5629	84535-5629	94535-5629	94538-5629
Fair / Rizzini	Express	64535-5691	74535-5691	84535-5691	94535-5691	94538-5691
FN Browning	A-Bolt	64535-5620	74535-5620	84535-5620	94535-5620	94538-5620
	A-Bolt III	64535-562T	74535-562T	84535-562T	94535-562T	94538-562T
	A-Bolt WSSM	64535-561G	74535-561G	84535-561G	94535-561G	94538-561G
	BAR / BLR / CBL / Acera	64535-5603	74535-5603	84535-5603	94535-5603	94538-5603
	Eurobolt	64535-5678	74535-5678	84535-5678	94535-5678	94538-5678
	European	64535-5656	74535-5656	84535-5656	94535-5656	94538-5656
	Maral	64535-562J	74535-562J	84535-562J	94535-562J	94538-562J
	X-Bolt	64535-561P	74535-561P	84535-561P	94535-561P	94538-561P
Haenel	Jäger 10 (bis Serien-Nr. JX-000920)	64535-561W	74535-561W	84535-561W	94535-561W	94538-561W
	Jäger 10 (ab Serien-Nr. JX-000921)	64535-562C	74535-562C	84535-562C	94535-562C	94538-562C
	SLB 2000+	64535-562I	74535-562I	84535-562I	94535-562I	94538-562I
H&K	SLB 2000	64535-5608	74535-5608	84535-5608	94535-5608	94538-5608
Heym	SR 20	64535-5660	74535-5660	84535-5660	94535-5660	94538-5660
	SR 21	64535-5622	74535-5622	84535-5622	94535-5622	94538-5622
	SR 30	64535-5690	74535-5690	84535-5690	94535-5690	94538-5690
Howa	1500	64535-5659	74535-5659	84535-5659	94535-5659	94538-5659
Krico	600 / 700 / 900 / 902 Deluxe	64535-5606	74535-5606	84535-5606	94535-5606	94538-5606
Kriehoff	Semprio	64535-561C	74535-561C	84535-561C	94535-561C	94538-561C
Mauser	66	64535-5609	74535-5609	84535-5609	94535-5609	94538-5609
	M 94	64535-5694	74535-5694	84535-5694	94535-5694	94538-5694
	M 96	64535-5696	74535-5696	84535-5696	94535-5696	94538-5696
	M 96 (ab Serien-Nr. 12000) / M 97	64535-5697	74535-5697	84535-5697	94535-5697	94538-5697
	K 98 (und Nachbauten)	64535-5610	74535-5610	84535-5610	94535-5610	94538-5610
	M 12	64535-562L	74535-562L	84535-562L	94535-562L	94538-562L
Merkel	SR1	64535-5698	74535-5698	84535-5698	94535-5698	94538-5698
	SR1 Basic	64535-562D	74535-562D	84535-562D	94535-562D	94538-562D
Remington	700 (Gewinde UNS 6-48)	64535-5612	74535-5612	84535-5612	94535-5612	94538-5612
	700 (Gewinde UNS 8-40)	64535-561N	74535-561N	84535-561N	94535-561N	94538-561N
	783	64535-562S	74535-562S	84535-562S	94535-562S	94538-562S
	7400 / 7600 / 750	64535-5613	74535-5613	84535-5613	94535-5613	94538-5613
	Seven	64535-5619	74535-5619	84535-5619	94535-5619	94538-5619
RWS-Rößler	Titan 3 / Titan 6 / Titan α	64535-5692	74535-5692	84535-5692	94535-5692	94538-5692
	Titan 16	64535-562G	74535-562G	84535-562G	94535-562G	94538-562G
Sabatti	Express	64535-561K	74535-561K	84535-561K	94535-561K	94538-561K
Sako	konisches Prisma / tapered dovetail	64535-5653	74535-5653	84535-5653	94535-5653	94538-5653
Sauer	80 / 90 / 92	64535-5615	74535-5615	84535-5615	94535-5615	94538-5615
	101	64535-562K	74535-562K	84535-562K	94535-562K	94538-562K
	200	64535-5616	74535-5616	84535-5616	94535-5616	94538-5616
	202	64535-5680	74535-5680	84535-5680	94535-5680	94538-5680
Savage	ebene Hülsenbrücke / flat Top	64535-5635	74535-5635	84535-5635	94535-5635	94538-5635
	gerundete Hülsenbrücke / rounded Top	64535-5693	74535-5693	84535-5693	94535-5693	94538-5693
Steyr-Mannlicher	Luxus (siehe Katalog auf Seite 61)					
	SBS-96	64535-5687	74535-5687	84535-5687	94535-5687	94538-5687
	SBS-96 Export/Pro Hunter/Classic/SM12/CLII	64535-5688	74535-5688	84535-5688	94535-5688	94538-5688
	Mannlicher-Schönauer GK	64535-5638	74535-5638		94535-5638	94538-5638
Swiss Arms	SHR-970 (Bohrungsabstand 21,9 mm)	64535-5640	74535-5640	84535-5640	94535-5640	94538-5640
Tikka	T3	64535-5681	74535-5681	84535-5681	94535-5681	94538-5681
Verney-Carron	Impact NT / Plus	64535-5647	74535-5647	84535-5647	94535-5647	94538-5647
Voere	LBW	64535-5655	74535-5655		94535-5655	94538-5655
Weatherby	Mark V / 300 / Vanguard	64535-5623	74535-5623	84535-5623	94535-5623	94538-5623
Winchester	70 short / long action	64535-5624	74535-5624	84535-5624	94535-5624	94538-5624
	70 Magnum (Baujahr nach 1964)	64535-5625	74535-5625	84535-5625	94535-5625	94538-5625
	70 WSM	64535-5611	74535-5611	84535-5611	94535-5611	94538-5611
	70 WSSM	64535-5669	74535-5669	84535-5669	94535-5669	94538-5669
	SXR Vulcan	64535-561J	74535-561J	84535-561J	94535-561J	94538-561J
Zastava	70	64535-5601	74535-5601	84535-5601	94535-5601	94538-5601

Swing mounts with 45° dovetail attachments / Montages pivotants avec 45° prisme

wahlweise mit folgenden ERAMATIC-Verschlüssen lieferbar:

- 45° Aufnahmeprisma
- Verlängerung 38 mm
- Bauhöhe: 19,0 mm
- GK-Prismenbreite 44 mm

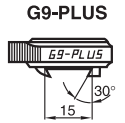
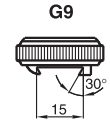
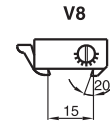
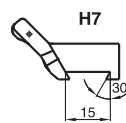
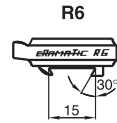
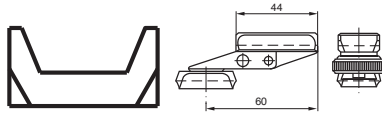

Anschütz	1780 / 1781	64544-382B	74544-382B	84544-382B	94544-382B	94548-382B
Antonio Zoli	1900	64544-3889	74544-3889	84544-3889	94544-3889	94548-3889
Benelli	ARGO	64544-3876	74544-3876	84544-3876	94544-3876	94548-3876
Beretta	689 gold sable / silver sable 2	64544-3899	74544-3899	84544-3899	94544-3899	94548-3899
Brügger CZ	Prisma 16,0 mm	64544-3861	74544-3861	84544-3861	94544-3861	94548-3861
	Prisma 19,5 mm	64544-3862	74544-3862	84544-3862	94544-3862	94548-3862
Chapuis	Express	64544-3829	74544-3829	84544-3829	94544-3829	94548-3829
Fair / Rizzini	Express	64544-3891	74544-3891	84544-3891	94544-3891	94548-3891
FN Browning	A-Bolt	64544-3820	74544-3820	84544-3820	94544-3820	94548-3820
	A-Bolt III	64544-382T	74544-382T	84544-382T	94544-382T	94548-382T
	A-Bolt WSSM	64544-381G	74544-381G	84544-381G	94544-381G	94548-381G
	BAR / BLR / CBL / Acera	64544-3803	74544-3803	84544-3803	94544-3803	94548-3803
	Eurobolt	64544-3878	74544-3878	84544-3878	94544-3878	94548-3878
	European	64544-3856	74544-3856	84544-3856	94544-3856	94548-3856
	Maral	64544-382J	74544-382J	84544-382J	94544-382J	94548-382J
	X-Bolt	64544-381P	74544-381P	84544-381P	94544-381P	94548-381P
Haenel	Jäger 10 (bis Serien-Nr. JX-000920)	64544-381W	74544-381W	84544-381W	94544-381W	94548-381W
	Jäger 10 (ab Serien-Nr. JX-000921)	64544-382C	74544-382C	84544-382C	94544-382C	94548-382C
	SLB 2000+	64544-382I	74544-382I	84544-382I	94544-382I	94548-382I
H&K	SLB 2000	64544-3808	74544-3808	84544-3808	94544-3808	94548-3808
Heym	SR 20	64544-3860	74544-3860	84544-3860	94544-3860	94548-3860
	SR 21	64544-3822	74544-3822	84544-3822	94544-3822	94548-3822
	SR 30	64544-3890	74544-3890	84544-3890	94544-3890	94548-3890
Howa	1500	64544-3859	74544-3859	84544-3859	94544-3859	94548-3859
Krico	600 / 700 / 900 / 902 Deluxe	64544-3806	74544-3806	84544-3806	94544-3806	94548-3806
Kriehoff	Semprio	64544-381C	74544-381C	84544-381C	94544-381C	94548-381C
Mauser	66	64544-3809	74544-3809	84544-3809	94544-3809	94548-3809
	M 94	64544-3894	74544-3894	84544-3894	94544-3894	94548-3894
	M 96	64544-3896	74544-3896	84544-3896	94544-3896	94548-3896
	M 96 (ab Serien-Nr. 12000) / M 97	64544-3897	74544-3897	84544-3897	94544-3897	94548-3897
	K 98 (und Nachbauten)	64544-3810	74544-3810	84544-3810	94544-3810	94548-3810
	M 12	64544-382L	74544-382L	84544-382L	94544-382L	94548-382L
Merkel	SR1	64544-3898	74544-3898	84544-3898	94544-3898	94548-3898
	SR1 Basic	64544-382D	74544-382D	84544-382D	94544-382D	94548-382D
Remington	700 (Gewinde UNS 6-48)	64544-3812	74544-3812	84544-3812	94544-3812	94548-3812
	700 (Gewinde UNS 8-40)	64544-381N	74544-381N	84544-381N	94544-381N	94548-381N
	783	64544-3825	74544-3825	84544-3825	94544-3825	94548-3825
	7400 / 7600 / 750	64544-3813	74544-3813	84544-3813	94544-3813	94548-3813
	Seven	64544-3819	74544-3819	84544-3819	94544-3819	94548-3819
RWS-Rößler	Titan 3 / Titan 6 / Titan α	64544-3892	74544-3892	84544-3892	94544-3892	94548-3892
	Titan 16	64544-382G	74544-382G	84544-382G	94544-382G	94548-382G
Sabatti	Express	64544-381K	74544-381K	84544-381K	94544-381K	94548-381K
Sako	konisches Prisma / tapered dovetail	64544-3853	74544-3853	84544-3853	94544-3853	94548-3853
Sauer	80 / 90 / 92	64544-3815	74544-3815	84544-3815	94544-3815	94548-3815
	101	64544-382K	74544-382K	84544-382K	94544-382K	94548-382K
	200	64544-3816	74544-3816	84544-3816	94544-3816	94548-3816
	202	64544-3880	74544-3880	84544-3880	94544-3880	94548-3880
Savage	ebene Hülsenbrücke / flat Top	64544-3835	74544-3835	84544-3835	94544-3835	94548-3835
	gerundete Hülsenbrücke / rounded Top	64544-3893	74544-3893	84544-3893	94544-3893	94548-3893
Steyr-Mannlicher	Luxus (siehe Katalog auf Seite 61)					
	SBS-96	64544-3887	74544-3887	84544-3887	94544-3887	94548-3887
	SBS-96 Export/Pro Hunter/Classic/SM12/CLII	64544-3888	74544-3888	84544-3888	94544-3888	94548-3888
	Mannlicher-Schönauer GK	64544-3838	74544-3838		94544-3838	94548-3838
Swiss Arms	SHR-970 (Bohrungsabstand 21,9 mm)	64544-3840	74544-3840	84544-3840	94544-3840	94548-3840
Tikka	T3	64544-3881	74544-3881	84544-3881	94544-3881	94548-3881
Verney-Carron	Impact NT / Plus	64544-3847	74544-3847	84544-3847	94544-3847	94548-3847
Voere	LBW	64544-3855	74544-3855		94544-3855	94548-3855
Weatherby	Mark V / 300 / Vanguard	64544-3823	74544-3823	84544-3823	94544-3823	94548-3823
Winchester	70 short / long action	64544-3824	74544-3824	84544-3824	94544-3824	94548-3824
	70 Magnum (Baujahr nach 1964)	64544-3825	74544-3825	84544-3825	94544-3825	94548-3825
	70 WSM	64544-3811	74544-3811	84544-3811	94544-3811	94548-3811
	70 WSSM	64544-3869	74544-3869	84544-3869	94544-3869	94548-3869
	SXR Vulcan	64544-381J	74544-381J	84544-381J	94544-381J	94548-381J
Zastava	70	64544-3801	74544-3801	84544-3801	94544-3801	94548-3801

Swing mounts with 45° dovetail attachments / Montages pivotants avec 45° prisme

wahlweise mit folgenden ERAMATIC-Verschlüssen lieferbar:

- 45° Aufnahmeprisma
- Verlängerung 56 mm
- Bauhöhe: 19,0 mm
- GK-Prismenbreite 44 mm

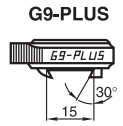
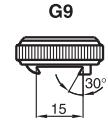
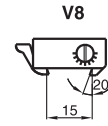
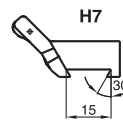
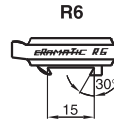
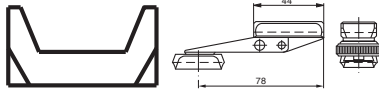

Anschütz	1780 / 1781	64544-562B	74544-562B	84544-562B	94544-562B	94548-562B
Antonio Zoli	1900	64544-5689	74544-5689	84544-5689	94544-5689	94548-5689
Benelli	ARGO	64544-5676	74544-5676	84544-5676	94544-5676	94548-5676
Beretta	689 gold sable / silver sable 2	64544-5699	74544-5699	84544-5699	94544-5699	94548-5699
Brügger	Prisma 16,0 mm	64544-5661	74544-5661	84544-5661	94544-5661	94548-5661
Brügger	Prisma 19,5 mm	64544-5662	74544-5662	84544-5662	94544-5662	94548-5662
Chapuis	Express	64544-5629	74544-5629	84544-5629	94544-5629	94548-5629
Fair / Rizzini	Express	64544-5691	74544-5691	84544-5691	94544-5691	94548-5691
FN Browning	A-Bolt	64544-5620	74544-5620	84544-5620	94544-5620	94548-5620
	A-Bolt III	64544-562T	74544-562T	84544-562T	94544-562T	94548-562T
	A-Bolt WSSM	64544-561G	74544-561G	84544-561G	94544-561G	94548-561G
	BAR / BLR / CBL / Acera	64544-5603	74544-5603	84544-5603	94544-5603	94548-5603
	Eurobolt	64544-5678	74544-5678	84544-5678	94544-5678	94548-5678
	European	64544-5656	74544-5656	84544-5656	94544-5656	94548-5656
	Maral	64544-562J	74544-562J	84544-562J	94544-562J	94548-562J
	X-Bolt	64544-561P	74544-561P	84544-561P	94544-561P	94548-561P
Haenel	Jäger 10 (bis Serien-Nr. JX-000920)	64544-561W	74544-561W	84544-561W	94544-561W	94548-561W
	Jäger 10 (ab Serien-Nr. JX-000921)	64544-562C	74544-562C	84544-562C	94544-562C	94548-562C
	SLB 2000+	64544-562I	74544-562I	84544-562I	94544-562I	94548-562I
H&K	SLB 2000	64544-5608	74544-5608	84544-5608	94544-5608	94548-5608
Heym	SR 20	64544-5660	74544-5660	84544-5660	94544-5660	94548-5660
	SR 21	64544-5622	74544-5622	84544-5622	94544-5622	94548-5622
	SR 30	64544-5690	74544-5690	84544-5690	94544-5690	94548-5690
Howa	1500	64544-5659	74544-5659	84544-5659	94544-5659	94548-5659
Krico	600 / 700 / 900 / 902 Deluxe	64544-5606	74544-5606	84544-5606	94544-5606	94548-5606
Krieghoff	Semprio	64544-561C	74544-561C	84544-561C	94544-561C	94548-561C
Mauser	66	64544-5609	74544-5609	84544-5609	94544-5609	94548-5609
	M 94	64544-5694	74544-5694	84544-5694	94544-5694	94548-5694
	M 96	64544-5696	74544-5696	84544-5696	94544-5696	94548-5696
	M 96 (ab Serien-Nr. 12000) / M 97	64544-5697	74544-5697	84544-5697	94544-5697	94548-5697
	K 98 (und Nachbauten)	64544-5610	74544-5610	84544-5610	94544-5610	94548-5610
	M 12	64544-562L	74544-562L	84544-562L	94544-562L	94548-562L
Merkel	SR1	64544-5698	74544-5698	84544-5698	94544-5698	94548-5698
	SR1 Basic	64544-562D	74544-562D	84544-562D	94544-562D	94548-562D
Remington	700 (Gewinde UNS 6-48)	64544-5612	74544-5612	84544-5612	94544-5612	94548-5612
	700 (Gewinde UNS 8-40)	64544-561N	74544-561N	84544-561N	94544-561N	94548-561N
	783	64544-562S	74544-562S	84544-562S	94544-562S	94548-562S
	7400 / 7600 / 750	64544-5613	74544-5613	84544-5613	94544-5613	94548-5613
	Seven	64544-5619	74544-5619	84544-5619	94544-5619	94548-5619
RWS-Röbber	Titan 3 / Titan 6 / Titan α	64544-5692	74544-5692	84544-5692	94544-5692	94548-5692
	Titan 16	64544-562G	74544-562G	84544-562G	94544-562G	94548-562G
Sabatti	Express	64544-561K	74544-561K	84544-561K	94544-561K	94548-561K
Sako	konisches Prisma / tapered dovetail	64544-5653	74544-5653	84544-5653	94544-5653	94548-5653
Sauer	80 / 90 / 92	64544-5615	74544-5615	84544-5615	94544-5615	94548-5615
	101	64544-562K	74544-562K	84544-562K	94544-562K	94548-562K
	200	64544-5616	74544-5616	84544-5616	94544-5616	94548-5616
	202	64544-5680	74544-5680	84544-5680	94544-5680	94548-5680
Savage	ebene Hülsenbrücke / flat Top	64544-5635	74544-5635	84544-5635	94544-5635	94548-5635
	gerundete Hülsenbrücke / rounded Top	64544-5693	74544-5693	84544-5693	94544-5693	94548-5693
Steyr-Mannlicher	Luxus (siehe Katalog auf Seite 61)					
	SBS-96	64544-5687	74544-5687	84544-5687	94544-5687	94548-5687
	SBS-96 Export/Pro Hunter/Classic/SM12/CLII	64544-5688	74544-5688	84544-5688	94544-5688	94548-5688
	Mannlicher-Schönauer GK	64544-5638	74544-5638		94544-5638	94548-5638
Swiss Arms	SHR-970 (Bohrungsabstand 21,9 mm)	64544-5640	74544-5640	84544-5640	94544-5640	94548-5640
Tikka	T3	64544-5681	74544-5681	84544-5681	94544-5681	94548-5681
Verney-Carron	Impact NT / Plus	64544-5647	74544-5647	84544-5647	94544-5647	94548-5647
Voere	LBW	64544-5655	74544-5655		94544-5655	94548-5655
Weatherby	Mark V / 300 / Vanguard	64544-5623	74544-5623	84544-5623	94544-5623	94548-5623
Winchester	70 short / long action	64544-5624	74544-5624	84544-5624	94544-5624	94548-5624
	70 Magnum (Baujahr nach 1964)	64544-5625	74544-5625	84544-5625	94544-5625	94548-5625
	70 WSM	64544-5611	74544-5611	84544-5611	94544-5611	94548-5611
	70 WSSM	64544-5669	74544-5669	84544-5669	94544-5669	94548-5669
	SXR Vulcan	64544-561J	74544-561J	84544-561J	94544-561J	94548-561J
Zastava	70	64544-5601	74544-5601	84544-5601	94544-5601	94548-5601

Swing mounts with dental profile for Swarovski SR / Montages pivotants profil „dentelé“ avec Swarovski SR

Verlängerter Hinterfuß erhältlich
Extended dovetail attachment available

wahlweise mit folgenden ERAMATIC-Verschlüssen lieferbar:

- Swarovski SR
- kurze Ausführung
- Bauhöhe: 19,0 mm
- Prismenbreite 35 mm

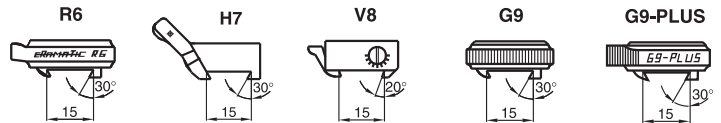
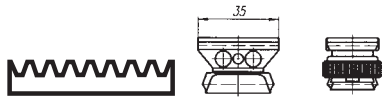

Anschütz	1780 / 1781	65335-002B	75335-002B	85335-002B	95335-002B	95338-002B
Antonio Zoli	1900	65335-0089	75335-0089	85335-0089	95335-0089	95338-0089
Benelli	ARGO	65335-0076	75335-0076	85335-0076	95335-0076	95338-0076
Beretta	689 gold sable / silver sable 2	65335-0099	75335-0099	85335-0099	95335-0099	95338-0099
Brünner CZ	Prisma 16,0 mm	65335-0061	75335-0061	85335-0061	95335-0061	95338-0061
	Prisma 19,5 mm	65335-0062	75335-0062	85335-0062	95335-0062	95338-0062
Chapuis	Express	65335-0029	75335-0029	85335-0029	95335-0029	95338-0029
Fair / Rizzini	Express	65335-0091	75335-0091	85335-0091	95335-0091	95338-0091
FN Browning	A-Bolt	65335-0020	75335-0020	85335-0020	95335-0020	95338-0020
	A-Bolt III	65335-002T	75335-002T	85335-002T	95335-002T	95338-002T
	A-Bolt WSSM	65335-001G	75335-001G	85335-001G	95335-001G	95338-001G
	BAR / BLR / CBL / Acera	65335-0003	75335-0003	85335-0003	95335-0003	95338-0003
	Eurobolt	65335-0078	75335-0078	85335-0078	95335-0078	95338-0078
	European	65335-0056	75335-0056	85335-0056	95335-0056	95338-0056
	Maral	65335-002J	75335-002J	85335-002J	95335-002J	95338-002J
	X-Bolt	65335-001P	75335-001P	85335-001P	95335-001P	95338-001P
Haenel	Jäger 10 (bis Serien-Nr. JX-000920)	65335-001W	75335-001W	85335-001W	95335-001W	95338-001W
	Jäger 10 (ab Serien-Nr. JX-000921)	65335-002C	75335-002C	85335-002C	95335-002C	95338-002C
	SLB 2000+	65335-002I	75335-002I	85335-002I	95335-002I	95338-002I
H&K	SLB 2000	65335-0008	75335-0008	85335-0008	95335-0008	95338-0008
Heym	SR 20	65335-0060	75335-0060	85335-0060	95335-0060	95338-0060
	SR 21	65335-0022	75335-0022	85335-0022	95335-0022	95338-0022
	SR 30	65335-0090	75335-0090	85335-0090	95335-0090	95338-0090
Howa	1500	65335-0059	75335-0059	85335-0059	95335-0059	95338-0059
Krico	600 / 700 / 900 / 902 Deluxe	65335-0006	75335-0006	85335-0006	95335-0006	95338-0006
Krieghoff	Semprio	65335-001C	75335-001C	85335-001C	95335-001C	95338-001C
Mauser	66	65335-0009	75335-0009	85335-0009	95335-0009	95338-0009
	M 94	65335-0094	75335-0094	85335-0094	95335-0094	95338-0094
	M 96	65335-0096	75335-0096	85335-0096	95335-0096	95338-0096
	M 96 (ab Serien-Nr. 12000) / M 97	65335-0097	75335-0097	85335-0097	95335-0097	95338-0097
	K 98 (und Nachbauten)	65335-0010	75335-0010	85335-0010	95335-0010	95338-0010
	M 12	65335-002L	75335-002L	85335-002L	95335-002L	95338-002L
Merkel	SR1	65335-0098	75335-0098	85335-0098	95335-0098	95338-0098
	SR1 Basic	65335-002D	75335-002D	85335-002D	95335-002D	95338-002D
Remington	700 (Gewinde UNS 6-48)	65335-0012	75335-0012	85335-0012	95335-0012	95338-0012
	700 (Gewinde UNS 8-40)	65335-001N	75335-001N	85335-001N	95335-001N	95338-001N
	783	65335-0025	75335-0025	85335-0025	95335-0025	95338-0025
	7400 / 7600 / 750	65335-0013	75335-0013	85335-0013	95335-0013	95338-0013
	Seven	65335-0019	75335-0019	85335-0019	95335-0019	95338-0019
RWS-Rößler	Titan 3 / Titan 6 / Titan α	65335-0092	75335-0092	85335-0092	95335-0092	95338-0092
	Titan 16	65335-002G	75335-002G	85335-002G	95335-002G	95338-002G
Sabatti	Express	65335-001K	75335-001K	85335-001K	95335-001K	95338-001K
Sako	konisches Prisma / tapered dovetail	65335-0053	75335-0053	85335-0053	95335-0053	95338-0053
Sauer	80 / 90 / 92	65335-0015	75335-0015	85335-0015	95335-0015	95338-0015
	101	65335-002K	75335-002K	85335-002K	95335-002K	95338-002K
	200	65335-0016	75335-0016	85335-0016	95335-0016	95338-0016
	202	65335-0080	75335-0080	85335-0080	95335-0080	95338-0080
Savage	ebene Hülsenbrücke / flat Top	65335-0035	75335-0035	85335-0035	95335-0035	95338-0035
	gerundete Hülsenbrücke / rounded Top	65335-0093	75335-0093	85335-0093	95335-0093	95338-0093
Steyr-Mannlicher	Luxus (siehe Katalog auf Seite 61)					
	SBS-96	65335-0087	75335-0087	85335-0087	95335-0087	95338-0087
	SBS-96 Export/Pro Hunter/Classic/SM12/CLII	65335-0088	75335-0088	85335-0088	95335-0088	95338-0088
	Mannlicher-Schönauer GK	65335-0038	75335-0038		95335-0038	95338-0038
Swiss Arms	SHR-970 (Bohrungsabstand 21,9 mm)	65335-0040	75335-0040	85335-0040	95335-0040	95338-0040
Tikka	T3	65335-0081	75335-0081	85335-0081	95335-0081	95338-0081
Verney-Carron	Impact NT / Plus	65335-0047	75335-0047	85335-0047	95335-0047	95338-0047
Voere	LBW	65335-0055	75335-0055		95335-0055	95338-0055
Weatherby	Mark V / 300 / Vanguard	65335-0023	75335-0023	85335-0023	95335-0023	95338-0023
Winchester	70 short / long action	65335-0024	75335-0024	85335-0024	95335-0024	95338-0024
	70 Magnum (Baujahr nach 1964)	65335-0025	75335-0025	85335-0025	95335-0025	95338-0025
	70 WSM	65335-0011	75335-0011	85335-0011	95335-0011	95338-0011
	70 WSSM	65335-0069	75335-0069	85335-0069	95335-0069	95338-0069
	SXR Vulcan	65335-001J	75335-001J	85335-001J	95335-001J	95338-001J
Zastava	70	65335-0001	75335-0001	85335-0001	95335-0001	95338-0001

Swing mounts with dental profile for Swarovski SR / Montages pivotants profil „dentelé“ Swarovski SR

wahlweise mit folgenden ERAMATIC-Verschlüssen lieferbar:

- Swarovski SR
- Verlängerung 38 mm
- Bauhöhe: 19,0 mm
- Prismenbreite 35 mm

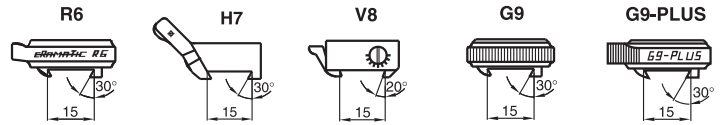
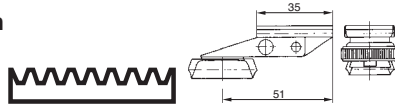

Anschütz	1780 / 1781	65335-382B	75335-382B	85335-382B	95335-382B	95338-382B
Antonio Zoli	1900	65335-3889	75335-3889	85335-3889	95335-3889	95338-3889
Benelli	ARGO	65335-3876	75335-3876	85335-3876	95335-3876	95338-3876
Beretta	689 gold sable / silver sable 2	65335-3899	75335-3899	85335-3899	95335-3899	95338-3899
Brünner CZ	Prisma 16,0 mm	65335-3861	75335-3861	85335-3861	95335-3861	95338-3861
	Prisma 19,5 mm	65335-3862	75335-3862	85335-3862	95335-3862	95338-3862
Chapuis	Express	65335-3829	75335-3829	85335-3829	95335-3829	95338-3829
Fair / Rizzini	Express	65335-3891	75335-3891	85335-3891	95335-3891	95338-3891
FN Browning	A-Bolt	65335-3820	75335-3820	85335-3820	95335-3820	95338-3820
	A-Bolt III	65335-382T	75335-382T	85335-382T	95335-382T	95338-382T
	A-Bolt WSSM	65335-381G	75335-381G	85335-381G	95335-381G	95338-381G
	BAR / BLR / CBL / Acera	65335-3803	75335-3803	85335-3803	95335-3803	95338-3803
	Eurobolt	65335-3878	75335-3878	85335-3878	95335-3878	95338-3878
	European	65335-3856	75335-3856	85335-3856	95335-3856	95338-3856
	Maral	65335-382J	75335-382J	85335-382J	95335-382J	95338-382J
	X-Bolt	65335-381P	75335-381P	85335-381P	95335-381P	95338-381P
Haenel	Jäger 10 (bis Serien-Nr. JX-000920)	65335-381W	75335-381W	85335-381W	95335-381W	95338-381W
	Jäger 10 (ab Serien-Nr. JX-000921)	65335-382C	75335-382C	85335-382C	95335-382C	95338-382C
	SLB 2000+	65335-382I	75335-382I	85335-382I	95335-382I	95338-382I
H&K	SLB 2000	65335-3808	75335-3808	85335-3808	95335-3808	95338-3808
Heym	SR 20	65335-3860	75335-3860	85335-3860	95335-3860	95338-3860
	SR 21	65335-3822	75335-3822	85335-3822	95335-3822	95338-3822
	SR 30	65335-3890	75335-3890	85335-3890	95335-3890	95338-3890
Howa	1500	65335-3859	75335-3859	85335-3859	95335-3859	95338-3859
Krico	600 / 700 / 900 / 902 Deluxe	65335-3806	75335-3806	85335-3806	95335-3806	95338-3806
Krieghoff	Semprio	65335-381C	75335-381C	85335-381C	95335-381C	95338-381C
Mauser	66	65335-3809	75335-3809	85335-3809	95335-3809	95338-3809
	M 94	65335-3894	75335-3894	85335-3894	95335-3894	95338-3894
	M 96	65335-3896	75335-3896	85335-3896	95335-3896	95338-3896
	M 96 (ab Serien-Nr. 12000) / M 97	65335-3897	75335-3897	85335-3897	95335-3897	95338-3897
	K 98 (und Nachbauten)	65335-3810	75335-3810	85335-3810	95335-3810	95338-3810
	M 12	65335-382L	75335-382L	85335-382L	95335-382L	95338-382L
Merkel	SR1	65335-3898	75335-3898	85335-3898	95335-3898	95338-3898
	SR1 Basic	65335-382D	75335-382D	85335-382D	95335-382D	95338-382D
Remington	700 (Gewinde UNS 6-48)	65335-3812	75335-3812	85335-3812	95335-3812	95338-3812
	700 (Gewinde UNS 8-40)	65335-381N	75335-381N	85335-381N	95335-381N	95338-381N
	783	65335-3825	75335-3825	85335-3825	95335-3825	95338-3825
	7400 / 7600 / 750	65335-3813	75335-3813	85335-3813	95335-3813	95338-3813
	Seven	65335-3819	75335-3819	85335-3819	95335-3819	95338-3819
RWS-Rößler	Titan 3 / Titan 6 / Titan α	65335-3892	75335-3892	85335-3892	95335-3892	95338-3892
	Titan 16	65335-382G	75335-382G	85335-382G	95335-382G	95338-382G
Sabatti	Express	65335-381K	75335-381K	85335-381K	95335-381K	95338-381K
Sako	konisches Prisma / tapered dovetail	65335-3853	75335-3853	85335-3853	95335-3853	95338-3853
Sauer	80 / 90 / 92	65335-3815	75335-3815	85335-3815	95335-3815	95338-3815
	101	65335-382K	75335-382K	85335-382K	95335-382K	95338-382K
	200	65335-3816	75335-3816	85335-3816	95335-3816	95338-3816
	202	65335-3880	75335-3880	85335-3880	95335-3880	95338-3880
Savage	ebene Hülsenbrücke / flat Top	65335-3835	75335-3835	85335-3835	95335-3835	95338-3835
	gerundete Hülsenbrücke / rounded Top	65335-3893	75335-3893	85335-3893	95335-3893	95338-3893
Steyr-Mannlicher	Luxus (siehe Katalog auf Seite 61)					
	SBS-96	65335-3887	75335-3887	85335-3887	95335-3887	95338-3887
	SBS-96 Export/Pro Hunter/Classic/SM12/CLII	65335-3888	75335-3888	85335-3888	95335-3888	95338-3888
	Mannlicher-Schönauer GK	65335-3838	75335-3838		95335-3838	95338-3838
Swiss Arms	SHR-970 (Bohrungsabstand 21,9 mm)	65335-3840	75335-3840	85335-3840	95335-3840	95338-3840
Tikka	T3	65335-3881	75335-3881	85335-3881	95335-3881	95338-3881
Verney-Carron	Impact NT / Plus	65335-3847	75335-3847	85335-3847	95335-3847	95338-3847
Voere	LBW	65335-3855	75335-3855		95335-3855	95338-3855
Weatherby	Mark V / 300 / Vanguard	65335-3823	75335-3823	85335-3823	95335-3823	95338-3823
Winchester	70 short / long action	65335-3824	75335-3824	85335-3824	95335-3824	95338-3824
	70 Magnum (Baujahr nach 1964)	65335-3825	75335-3825	85335-3825	95335-3825	95338-3825
	70 WSM	65335-3811	75335-3811	85335-3811	95335-3811	95338-3811
	70 WSSM	65335-3869	75335-3869	85335-3869	95335-3869	95338-3869
	SXR Vulcan	65335-381J	75335-381J	85335-381J	95335-381J	95338-381J
Zastava	70	65335-3801	75335-3801	85335-3801	95335-3801	95338-3801

Swing mounts with dental profile for Swarovski SR / Montages pivotants profil „dentelé“ Swarovski SR

wahlweise mit folgenden ERAMATIC-Verschlüssen lieferbar:

- Swarovski SR
- Verlängerung 56 mm
- Bauhöhe: 19,0 mm
- Prismenbreite 35 mm

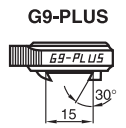
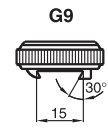
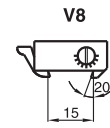
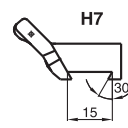
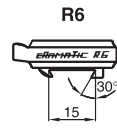

Anschütz	1780 / 1781	65335-562B	75335-562B	85335-562B	95335-562B	95338-562B
Antonio Zoli	1900	65335-5689	75335-5689	85335-5689	95335-5689	95338-5689
Benelli	ARGO	65335-5676	75335-5676	85335-5676	95335-5676	95338-5676
Beretta	689 gold sable / silver sable 2	65335-5699	75335-5699	85335-5699	95335-5699	95338-5699
Brünnner CZ	Prisma 16,0 mm	65335-5661	75335-5661	85335-5661	95335-5661	95338-5661
	Prisma 19,5 mm	65335-5662	75335-5662	85335-5662	95335-5662	95338-5662
Chapuis	Express	65335-5629	75335-5629	85335-5629	95335-5629	95338-5629
Fair / Rizzini	Express	65335-5691	75335-5691	85335-5691	95335-5691	95338-5691
FN Browning	A-Bolt	65335-5620	75335-5620	85335-5620	95335-5620	95338-5620
	A-Bolt III	65335-562T	75335-562T	85335-562T	95335-562T	95338-562T
	A-Bolt WSSM	65335-561G	75335-561G	85335-561G	95335-561G	95338-561G
	BAR / BLR / CBL / Acera	65335-5603	75335-5603	85335-5603	95335-5603	95338-5603
	Eurobolt	65335-5678	75335-5678	85335-5678	95335-5678	95338-5678
	European	65335-5656	75335-5656	85335-5656	95335-5656	95338-5656
	Maral	65335-562J	75335-562J	85335-562J	95335-562J	95338-562J
	X-Bolt	65335-561P	75335-561P	85335-561P	95335-561P	95338-561P
Haenel	Jäger 10 (bis Serien-Nr. JX-000920)	65335-561W	75335-561W	85335-561W	95335-561W	95338-561W
	Jäger 10 (ab Serien-Nr. JX-000921)	65335-562C	75335-562C	85335-562C	95335-562C	95338-562C
	SLB 2000+	65335-562I	75335-562I	85335-562I	95335-562I	95338-562I
H&K	SLB 2000	65335-5608	75335-5608	85335-5608	95335-5608	95338-5608
Heym	SR 20	65335-5660	75335-5660	85335-5660	95335-5660	95338-5660
	SR 21	65335-5622	75335-5622	85335-5622	95335-5622	95338-5622
	SR 30	65335-5690	75335-5690	85335-5690	95335-5690	95338-5690
Howa	1500	65335-5659	75335-5659	85335-5659	95335-5659	95338-5659
Krico	600 / 700 / 900 / 902 Deluxe	65335-5606	75335-5606	85335-5606	95335-5606	95338-5606
Krieghoff	Semprio	65335-561C	75335-561C	85335-561C	95335-561C	95338-561C
Mauser	66	65335-5609	75335-5609	85335-5609	95335-5609	95338-5609
	M 94	65335-5694	75335-5694	85335-5694	95335-5694	95338-5694
	M 96	65335-5696	75335-5696	85335-5696	95335-5696	95338-5696
	M 96 (ab Serien-Nr. 12000) / M 97	65335-5697	75335-5697	85335-5697	95335-5697	95338-5697
	K 98 (und Nachbauten)	65335-5610	75335-5610	85335-5610	95335-5610	95338-5610
	M 12	65335-562L	75335-562L	85335-562L	95335-562L	95338-562L
Merkel	SR1	65335-5698	75335-5698	85335-5698	95335-5698	95338-5698
	SR1 Basic	65335-562D	75335-562D	85335-562D	95335-562D	95338-562D
Remington	700 (Gewinde UNS 6-48)	65335-5612	75335-5612	85335-5612	95335-5612	95338-5612
	700 (Gewinde UNS 8-40)	65335-561N	75335-561N	85335-561N	95335-561N	95338-561N
	783	65335-5625	75335-5625	85335-5625	95335-5625	95338-5625
	7400 / 7600 / 750	65335-5613	75335-5613	85335-5613	95335-5613	95338-5613
	Seven	65335-5619	75335-5619	85335-5619	95335-5619	95338-5619
RWS-Rößler	Titan 3 / Titan 6 / Titan α	65335-5692	75335-5692	85335-5692	95335-5692	95338-5692
	Titan 16	65335-562G	75335-562G	85335-562G	95335-562G	95338-562G
Sabatti	Express	65335-561K	75335-561K	85335-561K	95335-561K	95338-561K
Sako	konisches Prisma / tapered dovetail	65335-5653	75335-5653	85335-5653	95335-5653	95338-5653
Sauer	80 / 90 / 92	65335-5615	75335-5615	85335-5615	95335-5615	95338-5615
	101	65335-562K	75335-562K	85335-562K	95335-562K	95338-562K
	200	65335-5616	75335-5616	85335-5616	95335-5616	95338-5616
	202	65335-5680	75335-5680	85335-5680	95335-5680	95338-5680
Savage	ebene Hülsenbrücke / flat Top	65335-5635	75335-5635	85335-5635	95335-5635	95338-5635
	gerundete Hülsenbrücke / rounded Top	65335-5693	75335-5693	85335-5693	95335-5693	95338-5693
Steyr-Mannlicher	Luxus (siehe Katalog auf Seite 61)					
	SBS-96	65335-5687	75335-5687	85335-5687	95335-5687	95338-5687
	SBS-96 Export/Pro Hunter/Classic/SM12/CLII	65335-5688	75335-5688	85335-5688	95335-5688	95338-5688
	Mannlicher-Schönauer GK	65335-5638	75335-5638		95335-5638	95338-5638
Swiss Arms	SHR-970 (Bohrungsabstand 21,9 mm)	65335-5640	75335-5640	85335-5640	95335-5640	95338-5640
Tikka	T3	65335-5681	75335-5681	85335-5681	95335-5681	95338-5681
Verney-Carron	Impact NT / Plus	65335-5647	75335-5647	85335-5647	95335-5647	95338-5647
Voere	LBW	65335-5655	75335-5655		95335-5655	95338-5655
Weatherby	Mark V / 300 / Vanguard	65335-5623	75335-5623	85335-5623	95335-5623	95338-5623
Winchester	70 short / long action	65335-5624	75335-5624	85335-5624	95335-5624	95338-5624
	70 Magnum (Baujahr nach 1964)	65335-5625	75335-5625	85335-5625	95335-5625	95338-5625
	70 WSM	65335-5611	75335-5611	85335-5611	95335-5611	95338-5611
	70 WSSM	65335-5669	75335-5669	85335-5669	95335-5669	95338-5669
	SXR Vulcan	65335-561J	75335-561J	85335-561J	95335-561J	95338-561J
Zastava	70	65335-5601	75335-5601	85335-5601	95335-5601	95338-5601

Swing mounts for S&B-Convex-Rail / Montages pivotants pour S&B avec profil „Convex“

wahlweise mit folgenden ERAMATIC-Verschlüssen lieferbar:

- S&B-Convex
- Verlängerung 38 mm
- Bauhöhe: 19,0 mm
- Prismenbreite 29 mm

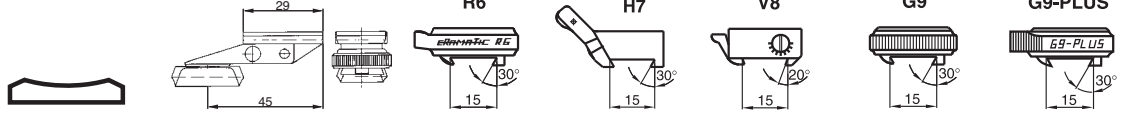

		R6	H7	V8	G9	G9-PLUS
Anschütz	1780 / 1781	66729-382B	76729-382B	86729-382B	96729-382B	96728-382B
Antonio Zoli	1900	66729-3889	76729-3889	86729-3889	96729-3889	96728-3889
Benelli	ARGO	66729-3876	76729-3876	86729-3876	96729-3876	96728-3876
Beretta	689 gold sable / silver sable 2	66729-3899	76729-3899	86729-3899	96729-3899	96728-3899
Brügger	Prisma 16,0 mm	66729-3861	76729-3861	86729-3861	96729-3861	96728-3861
	Prisma 19,5 mm	66729-3862	76729-3862	86729-3862	96729-3862	96728-3862
Chapuis	Express	66729-3829	76729-3829	86729-3829	96729-3829	96728-3829
Fair / Rizzini	Express	66729-3891	76729-3891	86729-3891	96729-3891	96728-3891
FN Browning	A-Bolt	66729-3820	76729-3820	86729-3820	96729-3820	96728-3820
	A-Bolt III	66729-382T	76729-382T	86729-382T	96729-382T	96728-382T
	A-Bolt WSSM	66729-381G	76729-381G	86729-381G	96729-381G	96728-381G
	BAR / BLR / CBL / Acera	66729-3803	76729-3803	86729-3803	96729-3803	96728-3803
	Eurobolt	66729-3878	76729-3878	86729-3878	96729-3878	96728-3878
	European	66729-3856	76729-3856	86729-3856	96729-3856	96728-3856
	Maral	66729-382J	76729-382J	86729-382J	96729-382J	96728-382J
	X-Bolt	66729-381P	76729-381P	86729-381P	96729-381P	96728-381P
Haenel	Jäger 10 (bis Serien-Nr. JX-000920)	66729-381W	76729-381W	86729-381W	96729-381W	96728-381W
	Jäger 10 (ab Serien-Nr. JX-000921)	66729-382C	76729-382C	86729-382C	96729-382C	96728-382C
	SLB 2000+	66729-382I	76729-382I	86729-382I	96729-382I	96728-382I
H&K	SLB 2000	66729-3808	76729-3808	86729-3808	96729-3808	96728-3808
Heym	SR 20	66729-3860	76729-3860	86729-3860	96729-3860	96728-3860
	SR 21	66729-3822	76729-3822	86729-3822	96729-3822	96728-3822
	SR 30	66729-3890	76729-3890	86729-3890	96729-3890	96728-3890
Howa	1500	66729-3859	76729-3859	86729-3859	96729-3859	96728-3859
Krico	600 / 700 / 900 / 902 Deluxe	66729-3806	76729-3806	86729-3806	96729-3806	96728-3806
Krieghoff	Semprio	66729-381C	76729-381C	86729-381C	96729-381C	96728-381C
Mauser	66	66729-3809	76729-3809	86729-3809	96729-3809	96728-3809
	M 94	66729-3894	76729-3894	86729-3894	96729-3894	96728-3894
	M 96	66729-3896	76729-3896	86729-3896	96729-3896	96728-3896
	M 96 (ab Serien-Nr. 12000) / M 97	66729-3897	76729-3897	86729-3897	96729-3897	96728-3897
	K 98 (und Nachbauten)	66729-3810	76729-3810	86729-3810	96729-3810	96728-3810
	M 12	66729-382L	76729-382L	86729-382L	96729-382L	96728-382L
Merkel	SR1	66729-3898	76729-3898	86729-3898	96729-3898	96728-3898
	SR1 Basic	66729-382D	76729-382D	86729-382D	96729-382D	96728-382D
Remington	700 (Gewinde UNS 6-48)	66729-3812	76729-3812	86729-3812	96729-3812	96728-3812
	700 (Gewinde UNS 8-40)	66729-381N	76729-381N	86729-381N	96729-381N	96728-381N
	783	66729-3825	76729-3825	86729-3825	96729-3825	96728-3825
	7400 / 7600 / 750	66729-3813	76729-3813	86729-3813	96729-3813	96728-3813
	Seven	66729-3819	76729-3819	86729-3819	96729-3819	96728-3819
RWS-Rößler	Titan 3 / Titan 6 / Titan α	66729-3892	76729-3892	86729-3892	96729-3892	96728-3892
	Titan 16	66729-382G	76729-382G	86729-382G	96729-382G	96728-382G
Sabatti	Express	66729-381K	76729-381K	86729-381K	96729-381K	96728-381K
Sako	konisches Prisma / tapered dovetail	66729-3853	76729-3853	86729-3853	96729-3853	96728-3853
Sauer	80 / 90 / 92	66729-3815	76729-3815	86729-3815	96729-3815	96728-3815
	101	66729-382K	76729-382K	86729-382K	96729-382K	96728-382K
	200	66729-3816	76729-3816	86729-3816	96729-3816	96728-3816
	202	66729-3880	76729-3880	86729-3880	96729-3880	96728-3880
Savage	ebene Hülsenbrücke / flat Top	66729-3835	76729-3835	86729-3835	96729-3835	96728-3835
	gerundete Hülsenbrücke / rounded Top	66729-3893	76729-3893	86729-3893	96729-3893	96728-3893
Steyr-Mannlicher	Luxus (siehe Katalog auf Seite 61)					
	SBS-96	66729-3887	76729-3887	86729-3887	96729-3887	96728-3887
	SBS-96 Export/Pro Hunter/Classic/SM12/CLII	66729-3888	76729-3888	86729-3888	96729-3888	96728-3888
	Mannlicher-Schönauer GK	66729-3838	76729-3838		96729-3838	96728-3838
Swiss Arms	SHR-970 (Bohrungsabstand 21,9 mm)	66729-3840	76729-3840	86729-3840	96729-3840	96728-3840
Tikka	T3	66729-3881	76729-3881	86729-3881	96729-3881	96728-3881
Verney-Carron	Impact NT / Plus	66729-3847	76729-3847	86729-3847	96729-3847	96728-3847
Voere	LBW	66729-3855	76729-3855		96729-3855	96728-3855
Weatherby	Mark V / 300 / Vanguard	66729-3823	76729-3823	86729-3823	96729-3823	96728-3823
Winchester	70 short / long action	66729-3824	76729-3824	86729-3824	96729-3824	96728-3824
	70 Magnum (Baujahr nach 1964)	66729-3825	76729-3825	86729-3825	96729-3825	96728-3825
	70 WSM	66729-3811	76729-3811	86729-3811	96729-3811	96728-3811
	70 WSSM	66729-3869	76729-3869	86729-3869	96729-3869	96728-3869
	SXR Vulcan	66729-381J	76729-381J	86729-381J	96729-381J	96728-381J
Zastava	70	66729-3801	76729-3801	86729-3801	96729-3801	96728-3801

Swing mounts for S&B-Convex-Rail / Montages pivotants pour S&B avec profil „Convex“

wahlweise mit folgenden ERAMATIC-Verschlüssen lieferbar:

- S&B-Convex
- Verlängerung 56 mm
- Bauhöhe: 19,0 mm
- Prismenbreite 29 mm

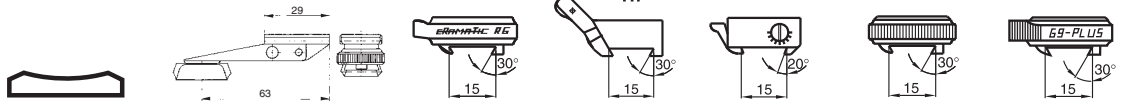

Anschütz	1780 / 1781	66729-562B	76729-562B	86729-562B	96729-562B	96728-562B
Antonio Zoli	1900	66729-5689	76729-5689	86729-5689	96729-5689	96728-5689
Benelli	ARGO	66729-5676	76729-5676	86729-5676	96729-5676	96728-5676
Beretta	689 gold sable / silver sable 2	66729-5699	76729-5699	86729-5699	96729-5699	96728-5699
Brünnner CZ	Prisma 16,0 mm	66729-5661	76729-5661	86729-5661	96729-5661	96728-5661
	Prisma 19,5 mm	66729-5662	76729-5662	86729-5662	96729-5662	96728-5662
Chapuis	Express	66729-5629	76729-5629	86729-5629	96729-5629	96728-5629
Fair / Rizzini	Express	66729-5691	76729-5691	86729-5691	96729-5691	96728-5691
FN Browning	A-Bolt	66729-5620	76729-5620	86729-5620	96729-5620	96728-5620
	A-Bolt III	66729-562T	76729-562T	86729-562T	96729-562T	96728-562T
	A-Bolt WSSM	66729-561G	76729-561G	86729-561G	96729-561G	96728-561G
	BAR / BLR / CBL / Acera	66729-5603	76729-5603	86729-5603	96729-5603	96728-5603
	Eurobolt	66729-5678	76729-5678	86729-5678	96729-5678	96728-5678
	European	66729-5656	76729-5656	86729-5656	96729-5656	96728-5656
	Maral	66729-562J	76729-562J	86729-562J	96729-562J	96728-562J
	X-Bolt	66729-561P	76729-561P	86729-561P	96729-561P	96728-561P
Haenel	Jäger 10 (bis Serien-Nr. JX-000920)	66729-561W	76729-561W	86729-561W	96729-561W	96728-561W
	Jäger 10 (ab Serien-Nr. JX-000921)	66729-562C	76729-562C	86729-562C	96729-562C	96728-562C
	SLB 2000+	66729-562I	76729-562I	86729-562I	96729-562I	96728-562I
H&K	SLB 2000	66729-5608	76729-5608	86729-5608	96729-5608	96728-5608
Heym	SR 20	66729-5660	76729-5660	86729-5660	96729-5660	96728-5660
	SR 21	66729-5622	76729-5622	86729-5622	96729-5622	96728-5622
	SR 30	66729-5690	76729-5690	86729-5690	96729-5690	96728-5690
Howa	1500	66729-5659	76729-5659	86729-5659	96729-5659	96728-5659
Krico	600 / 700 / 900 / 902 Deluxe	66729-5606	76729-5606	86729-5606	96729-5606	96728-5606
Krieghoff	Semprio	66729-561C	76729-561C	86729-561C	96729-561C	96728-561C
Mauser	66	66729-5609	76729-5609	86729-5609	96729-5609	96728-5609
	M 94	66729-5694	76729-5694	86729-5694	96729-5694	96728-5694
	M 96	66729-5696	76729-5696	86729-5696	96729-5696	96728-5696
	M 96 (ab Serien-Nr. 12000) / M 97	66729-5697	76729-5697	86729-5697	96729-5697	96728-5697
	K 98 (und Nachbauten)	66729-5610	76729-5610	86729-5610	96729-5610	96728-5610
	M 12	66729-562L	76729-562L	86729-562L	96729-562L	96728-562L
Merkel	SR1	66729-5698	76729-5698	86729-5698	96729-5698	96728-5698
	SR1 Basic	66729-562D	76729-562D	86729-562D	96729-562D	96728-562D
Remington	700 (Gewinde UNS 6-48)	66729-5612	76729-5612	86729-5612	96729-5612	96728-5612
	700 (Gewinde UNS 8-40)	66729-561N	76729-561N	86729-561N	96729-561N	96728-561N
	783	66729-5625	76729-5625	86729-5625	96729-5625	96728-5625
	7400 / 7600 / 750	66729-5613	76729-5613	86729-5613	96729-5613	96728-5613
	Seven	66729-5619	76729-5619	86729-5619	96729-5619	96728-5619
RWS-Rößler	Titan 3 / Titan 6 / Titan α	66729-5692	76729-5692	86729-5692	96729-5692	96728-5692
	Titan 16	66729-562G	76729-562G	86729-562G	96729-562G	96728-562G
Sabatti	Express	66729-561K	76729-561K	86729-561K	96729-561K	96728-561K
Sako	konisches Prisma / tapered dovetail	66729-5653	76729-5653	86729-5653	96729-5653	96728-5653
Sauer	80 / 90 / 92	66729-5615	76729-5615	86729-5615	96729-5615	96728-5615
	101	66729-562K	76729-562K	86729-562K	96729-562K	96728-562K
	200	66729-5616	76729-5616	86729-5616	96729-5616	96728-5616
	202	66729-5680	76729-5680	86729-5680	96729-5680	96728-5680
Savage	ebene Hülsenbrücke / flat Top	66729-5635	76729-5635	86729-5635	96729-5635	96728-5635
	gerundete Hülsenbrücke / rounded Top	66729-5693	76729-5693	86729-5693	96729-5693	96728-5693
Steyr-Mannlicher	Luxus (siehe Katalog auf Seite 61)					
	SBS-96	66729-5687	76729-5687	86729-5687	96729-5687	96728-5687
	SBS-96 Export/Pro Hunter/Classic/SM12/CLII	66729-5688	76729-5688	86729-5688	96729-5688	96728-5688
	Mannlicher-Schönauer GK	66729-5638	76729-5638		96729-5638	96728-5638
Swiss Arms	SHR-970 (Bohrungsabstand 21,9 mm)	66729-5640	76729-5640	86729-5640	96729-5640	96728-5640
Tikka	T3	66729-5681	76729-5681	86729-5681	96729-5681	96728-5681
Verney-Carron	Impact NT / Plus	66729-5647	76729-5647	86729-5647	96729-5647	96728-5647
Voere	LBW	66729-5655	76729-5655		96729-5655	96728-5655
Weatherby	Mark V / 300 / Vanguard	66729-5623	76729-5623	86729-5623	96729-5623	96728-5623
Winchester	70 short / long action	66729-5624	76729-5624	86729-5624	96729-5624	96728-5624
	70 Magnum (Baujahr nach 1964)	66729-5625	76729-5625	86729-5625	96729-5625	96728-5625
	70 WSM	66729-5611	76729-5611	86729-5611	96729-5611	96728-5611
	70 WSSM	66729-5669	76729-5669	86729-5669	96729-5669	96728-5669
	SXR Vulcan	66729-561J	76729-561J	86729-561J	96729-561J	96728-561J
Zastava	70	66729-5601	76729-5601	86729-5601	96729-5601	96728-5601

RECKNAGEL

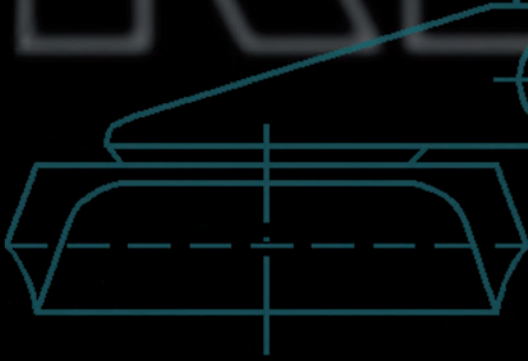

Locking systems / Serrures



ERAMATIC®-R6
Verschlusskörper mit automatischer Verriegelungstechnik. Für Prismenbasen und Schienenplatten mit 30°-Prisma; BH 9,5.



ERAMATIC®-H7
Verschlusskörper mit Entriegelungssicherung mittels Sperrklinke. Für Prismenbasen und Schienenplatten mit 30°-Prisma; BH 9,5.



ERAMATIC®-V8
Verschlusskörper mit Doppelstangenverschluss. Für Prismenbasen und Schienenplatten mit 20°-Prisma; BH 9,5.



ERAMATIC®-G9
Verschlusskörper mit integriertem Kurvenspannsystem; BH 9,5. Für 30°-Laufschienen mit 12 mm und 14 mm Prismenbreite sowie Prismenbasen und Schienenplatten mit 30°-Prisma und 15 mm Schienenbreite.



ERAMATIC®-G9-PLUS
Verschlusskörper mit integriertem Kurvenspannsystem und geriffeltem Daumen-Nocken; BH 9,5. Für Prismenbasen und Schienenplatten mit 30°-Prisma und 15 mm Schienenbreite.

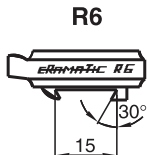

60100-0151

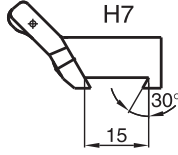

70100-0151

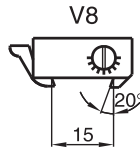

80100-0147

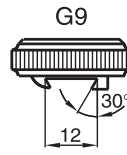

90100-0123

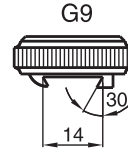

90100-0143

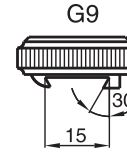

90100-0151

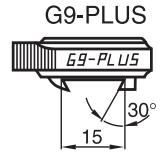

90108-0151

DISTANZROLLEN

Excentric windage adjustment rings / Calles intermédiaires

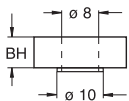

Distanzrollen mit zentraler und dezentraler Bohrung, für alle Schwenkmontagen mit R6, H7, V8, G9 und G9-PLUS-Verschlusskörper geeignet. Dezentrale Distanzrollen bieten eine supportähnliche Verstellmöglichkeit.



Distanzring für Höhenausgleich.
Dicke: 0,05 mm



Drehhorn zum Nachdrehen von Distanzrollen.

BH [mm]	zentral	dezentral
2,5	03000-0250	03005-0250
4,0		03005-0400
6,5		03005-0650
7,0	03000-0700	03005-0700
12,0	03000-1200	03005-1200
15,0		03005-1500

03010-0005	03020-0000

TL-DISTANZSCHEIBEN

TL-Spacers / Calles intermédiaires TL



TL-Distanzscheiben in drei verschiedenen Bauhöhen für die Feinabstimmung zwischen Verschlusskörper und Oberteil bei ERAMATIC-TL-Hinterfüßen.

0,05 mm

03018-8005

0,1 mm

03018-8010

0,2 mm

03018-8020

Rear rings and dovetail attachments with different locking systems / Pieds arrière avec serrures

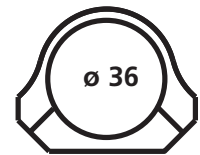
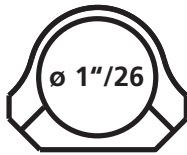

ERAMATIC®-R6

Verschlusskörper mit automatischer Verriegelungstechnik. Für 30°-Prisma und 15 mm Prismenbreite.



BH 15,0	BH 15,0	BH 15,0	BH 15,0
60800-2602	60800-3002	60800-3402	60800-3602
BH 19,5	BH 19,5	BH 19,5	BH 19,5
60800-2607	60800-3007	60800-3407	60800-3607
BH 24,5	BH 24,5	BH 24,5	BH 24,5
60800-2612	60800-3012	60800-3412	60800-3612

ERAMATIC®-H7

Verschlusskörper mit Entriegelungssicherung mittels Sperrklinke. Für 30°-Prisma und 15 mm Prismenbreite.



BH 15,0	BH 15,0	BH 15,0	BH 15,0
70800-2602	70800-3002	70800-3402	70800-3602
BH 19,5	BH 19,5	BH 19,5	BH 19,5
70800-2607	70800-3007	70800-3407	70800-3607
BH 24,5	BH 24,5	BH 24,5	BH 24,5
70800-2612	70800-3012	70800-3412	70800-3612

ERAMATIC®-V8

Verschlusskörper mit Doppelstangen-Verschluss. Für 20°-Prisma und 15 mm Prismenbreite.



BH 15,0	BH 15,0	BH 15,0	BH 15,0
80800-2602	80800-3002	80800-3402	80800-3602
BH 19,5	BH 19,5	BH 19,5	BH 19,5
80800-2607	80800-3007	80800-3407	80800-3607
BH 24,5	BH 24,5	BH 24,5	BH 24,5
80800-2612	80800-3012	80800-3412	80800-3612

ERAMATIC®-G9

Verschlusskörper mit integriertem Kurvenspannsystem. Für 30°-Prisma und 12 mm Prismenbreite.



BH 15,0	BH 15,0	BH 15,0	BH 15,0
90812-2602	90812-3002	90812-3402	90812-3602
BH 19,5	BH 19,5	BH 19,5	BH 19,5
90812-2607	90812-3007	90812-3407	90812-3607
BH 24,5	BH 24,5	BH 24,5	BH 24,5
90812-2612	90812-3012	90812-3412	90812-3612

ERAMATIC®-G9

Verschlusskörper mit integriertem Kurvenspannsystem. Für 30°-Prisma und 14 mm Prismenbreite.



BH 15,0	BH 15,0	BH 15,0	BH 15,0
90814-2602	90814-3002	90814-3402	90814-3602
BH 19,5	BH 19,5	BH 19,5	BH 19,5
90814-2607	90814-3007	90814-3407	90814-3607
BH 24,5	BH 24,5	BH 24,5	BH 24,5
90814-2612	90814-3012	90814-3412	90814-3612

ERAMATIC®-G9

Verschlusskörper mit integriertem Kurvenspannsystem. Für 30°-Prisma und 15 mm Prismenbreite.



BH 15,0	BH 15,0	BH 15,0	BH 15,0
90800-2602	90800-3002	90800-3402	90800-3602
BH 19,5	BH 19,5	BH 19,5	BH 19,5
90800-2607	90800-3007	90800-3407	90800-3607
BH 24,5	BH 24,5	BH 24,5	BH 24,5
90800-2612	90800-3012	90800-3412	90800-3612

ERAMATIC®-G9-PLUS

Verschlusskörper mit integriertem Kurvenspannsystem und geriffeltem Daumen-Nocken. Für 30°-Prisma und 15 mm Prismenbreite.



BH 15,0	BH 15,0	BH 15,0	BH 15,0
90808-2602	90808-3002	90808-3402	90808-3602
BH 19,5	BH 19,5	BH 19,5	BH 19,5
90808-2607	90808-3007	90808-3407	90808-3607
BH 24,5	BH 24,5	BH 24,5	BH 24,5
90808-2612	90808-3012	90808-3412	90808-3612

Rear rings and dovetail attachments with different locking systems / Pieds arrière avec serrures



ERAMATIC®-R6

Verschlusskörper mit automatischer Verriegelungstechnik. Für 30°-Prisma und 15 mm Prismenbreite.



BH 15,0	BH 15,5	BH 16,0	BH 15,5
60800-7002	60800-4502	60800-5302	60800-6702
BH 19,5	BH 20,0	BH 20,5	BH 20,0
60800-7007	60800-4507	60800-5307	60800-6707
BH 24,5	BH 25,0	BH 25,5	BH 25,0
60800-7012	60800-4512	60800-5312	60800-6712

ERAMATIC®-H7

Verschlusskörper mit Entriegelungssicherung mittels Sperrklinke. Für 30°-Prisma und 15 mm Prismenbreite.



BH 15,0	BH 15,5	BH 16,0	BH 15,5
70800-7002	70800-4502	70800-5302	70800-6702
BH 19,5	BH 20,0	BH 20,5	BH 20,0
70800-7007	70800-4507	70800-5307	70800-6707
BH 24,5	BH 25,0	BH 25,5	BH 25,0
70800-7012	70800-4512	70800-5312	70800-6712

ERAMATIC®-V8

Verschlusskörper mit Doppelstangen-Verschluss. Für 20°-Prisma und 15 mm Prismenbreite.



BH 15,0	BH 15,5	BH 16,0	BH 15,5
80800-7002	80800-4502	80800-5302	80800-6702
BH 19,5	BH 20,0	BH 20,5	BH 20,0
80800-7007	80800-4507	80800-5307	80800-6707
BH 24,5	BH 25,0	BH 25,5	BH 25,0
80800-7012	80800-4512	80800-5312	80800-6712

ERAMATIC®-G9

Verschlusskörper mit integriertem Kurvenspannsystem. Für 30°-Prisma und 12 mm Prismenbreite.



BH 15,0	BH 15,5	BH 16,0	BH 15,5
90812-7002	90812-4502	90812-5302	90812-6702
BH 19,5	BH 20,0	BH 20,5	BH 20,0
90812-7007	90812-4507	90812-5307	90812-6707
BH 24,5	BH 25,0	BH 25,5	BH 25,0
90812-7012	90812-4512	90812-5312	90812-6712

ERAMATIC®-G9

Verschlusskörper mit integriertem Kurvenspannsystem. Für 30°-Prisma und 14 mm Prismenbreite.



BH 15,0	BH 15,5	BH 16,0	BH 15,5
90814-7002	90814-4502	90814-5302	90814-6702
BH 19,5	BH 20,0	BH 20,5	BH 20,0
90814-7007	90814-4507	90814-5307	90814-6707
BH 24,5	BH 25,0	BH 25,5	BH 25,0
90814-7012	90814-4512	90814-5312	90814-6712

ERAMATIC®-G9

Verschlusskörper mit integriertem Kurvenspannsystem. Für 30°-Prisma und 15 mm Prismenbreite.



BH 15,0	BH 15,5	BH 16,0	BH 15,5
90800-7002	90800-4502	90800-5302	90800-6702
BH 19,5	BH 20,0	BH 20,5	BH 20,0
90800-7007	90800-4507	90800-5307	90800-6707
BH 24,5	BH 25,0	BH 25,5	BH 25,0
90800-7012	90800-4512	90800-5312	90800-6712

ERAMATIC®-G9-PLUS

Verschlusskörper mit integriertem Kurvenspannsystem und geriffeltem Daumen-Nocken. Für 30°-Prisma und 15 mm Prismenbreite.



BH 15,0	BH 15,5	BH 16,0	BH 15,5
90808-7002	90808-4502	90808-5302	90808-6702
BH 19,5	BH 20,0	BH 20,5	BH 20,0
90808-7007	90808-4507	90808-5307	90808-6707
BH 24,5	BH 25,0	BH 25,5	BH 25,0
90808-7012	90808-4512	90808-5312	90808-6712

Rear rings and dovetail attachments / Colliers arrières et prismes



Hinterer Klemmring, Standard Ausführung, aus Stahl.
Verschiedene Ringbreiten und Bauhöhen.

Ringbreite	BH	ø 1"/26 mm	ø 30 mm	ø 34 mm	ø 36 mm	ø 40 mm
15,0	3,0	03050-2603	03050-3003	03050-3403	03050-3603	
15,0	5,5	03050-2605	03050-3005	03050-3405		
15,0	8,0	03050-2608	03050-3008			
20,0	3,0	03052-2603	03052-3003			03052-4003



Hinterer Klemmring, verlängerte Ausführung, aus Stahl.
Verlängerung: 25 mm, Bauhöhe: 5,0 mm

ø 1"/26 mm	ø 30 mm
03057-2605	03057-3005



Hinterer Klemmring, Light-Ausführung,
aus hochfestem Aluminium.
Bauhöhe: 3,0 mm, Ringbreite: 15 mm

ø 1"/26 mm	ø 30 mm
03050-2403	03050-2803



Hinteres 70°-Aufnahmeprisma für Zielfernrohre mit Mittelrohrschiene. Bauhöhe: 3,0 mm.

03050-7003



Hinteres 70°-Aufnahmeprisma, verlängerte Ausführung, für Zielfernrohre mit Mittelrohrschiene. Bauhöhe: 3,0 mm.

03057-7003



Hinteres 45°-Aufnahmeprisma für Zeiss-ZM-Zielfernrohre. Bauhöhe: 3,5 mm.

03050-4504



Hinteres Aufnahmeprisma für Swarovski-SR. Bauhöhe: 4,0 mm.

03050-5304



Hinteres Aufnahmeprisma für Swarovski-SR, verlängerte Ausführung, besonders geeignet für Swarovski Z6-Zielfernrohre. Bauhöhe: 4,0 mm

03057-5304



Hinteres Aufnahmeprisma für S&B-Convex-Schiene. Bauhöhe: 3,5 mm.

03050-6704



Hinterer Klemmring für Steyr-Mannlicher-Schönauer GK. Bauhöhe: 4,0 mm.

ø 1"/26 mm	ø 30 mm
03038-2604	03038-3004



Hinteres 45°-Aufnahmeprisma für Steyr-Mannlicher-Schönauer GK. Bauhöhe: 4,5 mm.

03038-4504



Hinteres 70°-Aufnahmeprisma für Steyr-Mannlicher-Schönauer GK. Bauhöhe: 4,0 mm.

03038-7004



Hinteres Aufnahmeprisma für Swarovski-SR für Steyr-Mannlicher-Schönauer GK. Bauhöhe: 4,5 mm

03038-5304



Hinteres Aufnahmeprisma für S&B-Convex-Schiene für Steyr-Mannlicher-Schönauer GK. Bauhöhe: 4,5 mm.

03038-6704

Rear bases to be fixed on the barrel rib / Socles arrière pour serrures



Schieneplatte mit 20°-Prisma, gebohrt und brüniert, zum Einsetzen in Drillingssschienen.
Für V8-Verschlusskörper.

Länge: 31 mm

für Drillinge	BH [mm]	
Sauer	3,7	80300-0037
Heym, Krieghoff	4,5	80300-0045
Suhler	5,5	80300-0055

Schieneplatte mit 30°-Prisma, gebohrt und brüniert, zum Einsetzen in Drillingssschienen.

Für R6, H7, G9 und G9-PLUS-Verschlusskörper.

Länge: 31 mm

für Drillinge	BH [mm]	
Sauer	3,7	90300-0037
Heym, Krieghoff	4,5	90300-0045
Suhler	5,5	90300-0055



Schieneplatte mit 20°-Prisma, Bohrung und Anschlag, zum Einsetzen in Laufschiene.

Für V8-Verschlusskörper.

Länge: 18 mm, Bauhöhe: 2,7 mm

80305-0027

Schieneplatte mit 30°-Prisma, Bohrung und Anschlag, zum Einsetzen in Laufschiene.

Für R6, H7, G9 und G9-PLUS-Verschlusskörper.

Länge: 18 mm, Bauhöhe: 2,7 mm

90305-0027

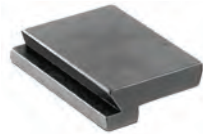

Schieneplatte mit 20°-Prisma, Anschlag und angeschrägten Stirnseiten, zum Einpassen in Laufschiene. Für V8-Verschlusskörper.

Länge: 22 mm, Bauhöhe: 2,7 mm

80310-0027

Schieneplatte mit 30°-Prisma, Anschlag und angeschrägten Stirnseiten, zum Einpassen in Laufschiene.

Für R6, H7, G9 und G9-PLUS-Verschlusskörper.

Länge: 22 mm, Bauhöhe: 2,7 mm

90310-0027



Schieneplatte mit 20°-Prisma und angeschrägten Stirnseiten, zum Einpassen in Laufschiene.

Für V8-Verschlusskörper.

Länge: 22 mm, Bauhöhe: 2,7 mm

80315-0027

Schieneplatte mit 30°-Prisma und angeschrägten Stirnseiten, zum Einpassen in Laufschiene.

Für R6, H7, G9 und G9-PLUS-Verschlusskörper.

BH 2,7 mm, Länge: 22 mm 90315-0027

BH 3,2 mm, Länge: 30 mm 90325-0027

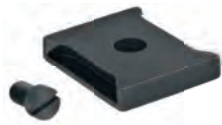

Schieneplatte mit 30°-Prisma und Bohrung, zum Einsetzen in das hintere Schließchen für Umbau von Suhler Einhakmontage auf Schwenkmontage. Erhältlich in zwei verschiedenen Breiten; Länge 22 mm; eine Befestigungsschraube gehört zum Lieferumfang.

Rear base to be fitted into the rear lock of a Claw Mount for installation of an ERA-swing mount with 30° rear lock. Available 18 or 20 mm wide; length 22 mm. A fixing screw is included.

18 mm breit: 90315-5327

20 mm breit: 90325-5327

18 mm breit ohne Bohrung: 90315-5300

SCHIENENSTÜCKE

Dovetail scope / Éléments de rails



Schienestück mit 30°-Prisma für Drillinge. Prisma passt für R6, H7, G9 und G9-PLUS-Verschlusskörper. Länge: 110,0 mm

90400-0000



Schienestück mit 30°-Prisma für BBF. Prisma passt für R6, H7, G9 und G9-PLUS-Verschlusskörper. Länge: 110,0 mm, Bauhöhe: 3,5 mm

90405-0035

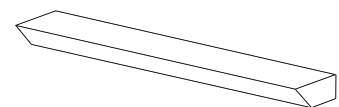

Schienestücke für Montagen mit 70°-Aufnahmepismen. Ausführung in zwei Längen. Bauhöhe: 8,0 mm

250 mm: 90410-0250 300 mm: 90410-0300

Rear bases / Embases arrières

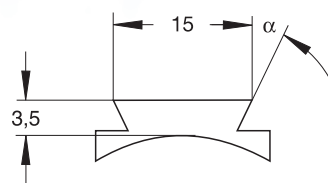

Hintere Prismenbasen zum Aufschrauben auf die Hülsenbrücke von Repetierbüchsen.
Passend zu:

- ERAMATIC-V8-Verschlusskörper, $\alpha = 20^\circ$
- ERAMATIC-R6-Verschlusskörper, $\alpha = 30^\circ$
- ERAMATIC-H7-Verschlusskörper, $\alpha = 30^\circ$
- ERAMATIC-G9-Verschlusskörper, $\alpha = 30^\circ$
- ERAMATIC-G9-PLUS-Verschlusskörper, $\alpha = 30^\circ$

Fabrikat	Modell	V8	R6 / H7 / G9
Anschütz	1780 / 1781	80600-002B	90600-002B
Antonio Zoli	1900	80600-0089	90600-0089
Benelli	ARGO	80600-0076	90600-0076
Beretta	689 gold sable / silver sable 2	80600-0099	90600-0099
Brünnler	Prisma 16,0 mm	80600-0061	90600-0061
	Prisma 19,5 mm	80600-0062	90600-0062
Chapuis	Express	80600-0029	90600-0029
Fair / Rizzini	Express	80600-0091	90600-0091
FN Browning	A-Bolt	80600-0020	90600-0020
	A-Bolt III	80600-002T	90600-002T
	A-Bolt WSSM	80600-001G	90600-001G
	BAR / BLR / CBL / Acera	80600-0003	90600-0003
	Eurobolt	80600-0078	90600-0078
	European	80600-0056	90600-0056
	Maral	80600-002J	90600-002J
	X-Bolt	80600-001P	90600-001P
Haenel	Jäger 10 (bis Serien-Nr. JX-000920)	80600-001W	90600-001W
	Jäger 10 (ab Serien-Nr. JX-000921)	80600-002C	90600-002C
	SLB 2000+	80600-002I	90600-002I
H&K	SLB 2000	80600-0008	90600-0008
Heym	SR 20	80600-0060	90600-0060
	SR 21	80600-0022	90600-0022
	SR 30	80600-0090	90600-0090
Howa	1500	80600-0059	90600-0059
Krico	600 / 700 / 900 / 902 Deluxe	80600-0006	90600-0006
Krieghoff	Semprio	80600-001C	90600-001C
Mauser	66	80600-0009	90600-0009
	M 94	80600-0094	90600-0094
	M 96	80600-0096	90600-0096
	M 96 (ab Serien-Nr. 12000) / M 97	80600-0097	90600-0097
	K 98 (und Nachbauten)	80600-0010	90600-0010
	M 12	80600-002L	90600-002L
Merkel	SR1	80600-0098	90600-0098
	SR1 Basic	80600-002D	90600-002D
Remington	700 (Gewinde UNS 6-48)	80600-0012	90600-0012
	700 (Gewinde UNS 8-40)	80600-001N	90600-001N
	783	80600-002S	90600-002S
	7400 / 7600 / 750	80600-0013	90600-0013
	Seven	80600-0019	90600-0019
RWS-Rößler	Titan 3 / Titan 6 / Titan α	80600-0092	90600-0092
	Titan 16	80600-002G	90600-002G
Sabatti	Rover 87 DL	80600-0075	90600-0075
	Express	80600-001K	90600-001K
Sako	konisches Prisma / tapered dovetail	80600-0053	90600-0053
Sauer	80 / 90 / 92	80600-0015	90600-0015
	101	80600-002K	90600-002K
	200	80600-0016	90600-0016
	202	80600-0080	90600-0080
Savage	ebene Hülsenbrücke / flat top	80600-0035	90600-0035
	gerundete Hülsenbrücke / rounded top	80600-0093	90600-0093
Steyr-Mannlicher	SBS-96	80600-0087	90600-0087
	SBS-96 Export / Pro Hunter / Classic / SM12 / CLII	80600-0088	90600-0088
	Mannlicher-Schönauer GK	-	90600-0038
Swiss Arms	SHR-970 (Gewindeabstand 21,9 mm)	80600-0040	90600-0040
Tikka	T3	80600-0081	90600-0081
Verney-Carron	Impact NT / Plus	80600-0047	90600-0047
Voere	LBW	-	90600-0055
Weatherby	Mark V / 300 / Vanguard	80600-0023	90600-0023
Winchester	70 short / long action	80600-0024	90600-0024
	70 Magnum (Baujahr nach 1964)	80600-0025	90600-0025
	70 WSM	80600-001I	90600-001I
	70 WSSM	80600-0069	90600-0069
	SXR Vulcan	80600-001J	90600-001J
Zastava	70	80600-0001	90600-0001

Front bases / Embasses avant

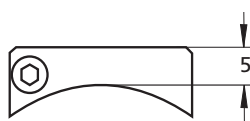

Vorderbasen für Klemmringe und Aufnahmeprismen mit Pivotzapfen, zum Aufschrauben auf den Hülsenkopf. Mittels Justier- und Konterschraube kann eine Feineinstellung der Zapfenaufnahme vorgenommen werden.

Fabrikat	Modell	
Anschütz	1780 / 1781	03200-002B
Antonio Zoli	1900	03200-0089
Benelli	ARGO	03200-0076
Beretta	689 gold sable / silver sable 2	03200-0099
Brünnner	Prisma 16,0 mm	03200-0061
	Prisma 19,5 mm	03200-0062
Chapuis	Express	03200-0029
Fair / Rizzini	Express	03200-0091
FN Browning	A-Bolt	03200-0020
	A-Bolt III	03200-002T
	A-Bolt WSSM	03200-001G
	BAR / BLR / CBL / Acera	03200-0003
	Eurobolt	03200-0078
	European	03200-0056
	Maral	03200-002J
	X-Bolt	03200-001P
Haenel	Jäger 10 (bis Serien-Nr. JX-000920)	03200-001W
	Jäger 10 (ab Serien-Nr. JX-000921)	03200-002C
	SLB 2000+	03200-002I
H&K	SLB 2000	03200-0008
Heym	SR 20	03200-0060
	SR 21	03200-0022
	SR 30	03200-0090
Howa	1500	03200-0059
Krico	600 / 700 / 900 / 902 Deluxe	03200-0006
Krieghoff	Semprio	03200-001C
Mauser	66	03200-0009
	M 94	03200-0094
	M 96	03200-0096
	M 96 (ab Serien-Nr. 12000) / M 97	03200-0097
	K 98 (und Nachbauten)	03200-0010
	M 12	03200-002L
Merkel	SR1	03200-0098
	SR1 Basic	03200-002D
Remington	700 (Gewinde UNS 6-48)	03200-0012
	700 (Gewinde UNS 8-40)	03200-001N
	783	03200-002S
	7400 / 7600 / 750	03200-0013
	Seven	03200-0019
RWS-Rößler	Titan 3 / Titan 6 / Titan α	03200-0092
	Titan 16	03200-002G
Sabatti	Rover 87 DL	03200-0075
	Express	03200-001K
Sako	konisches Prisma / tapered dovetail	03200-0053
Sauer	80 / 90 / 92	03200-0015
	101	03200-002K
	200	03200-0016
	202	03200-0080
Savage	ebene Hülsenbrücke / flat top	03200-0035
	gerundete Hülsenbrücke / rounded top	03200-0093
Steyr-Mannlicher	SBS-96	03200-0087
	SBS-96 Export / Pro Hunter / Classic / SM12 / CLII	03200-0088
	Mannlicher-Schönauer GK	03200-0038
Swiss Arms	SHR-970 (Gewindeabstand 21,9 mm)	03200-0040
Tikka	T3	03200-0081
Verney-Carron	Impact NT / Plus	03200-0047
Voere	LBW	03200-0055
Weatherby	Mark V / 300 / Vanguard	03200-0023
Winchester	70 short / long action	03200-0024
	70 Magnum (Baujahr nach 1964)	03200-0025
	70 WSM	03200-0011
	70 WSSM	03200-0069
	SXR Vulcan	03200-001J
Zastava	70	03200-0001



Front rings, short version / Colliers avants courts



Vordere Klemmringe mit Pivotzapfen, ohne Toleranzausgleich. Aus dem Vollen gefertigt. Ringbreite: 20 mm



Vordere Klemmringe in kurzer Ausführung, mit Toleranzausgleich. Der Klemmring sitzt in einer Aufnahme mit Pivotzapfen und wird mit zwei Innensechskantschrauben geklemmt. Bauhöhe: 13,5 mm, Ringbreite: 15 mm

BH [mm]	ø 1"/26 mm	ø 30 mm	ø 1"/26 mm	ø 30 mm	ø 34 mm	ø 36 mm
5,0	03400-2605	03400-3005	03405-2613	03405-3013	03405-3413	03405-3613
6,5	03400-2606	03400-3006				
7,5	03400-2607	03400-3007				
8,0	03400-2608	03400-3008				
9,5	03400-2609	03400-3009				
10,0	03400-2610	03400-3010				
12,0	03400-2612	03400-3012	ø 1"/26 mm		ø 30 mm	
13,5	03400-2613	03400-3013	03405-2413		03405-2813	

Ohne Abbildung:
Vordere Klemmringe aus hochfestem Aluminium, in Light-Ausführung, kurz mit Toleranzausgleich. Bauhöhe: 13,5 mm, Ringbreite: 15 mm



Vordere GK-Klemmringe in kurzer, besonders stabiler Ausführung, mit Toleranzausgleich. Der Klemmring sitzt in einer Aufnahme mit Pivotzapfen und wird mit drei Innensechskantschrauben geklemmt. Bauhöhe: 13,5 mm, Ringbreite: 22 mm

ø 1"/26 mm	ø 30 mm	ø 34 mm	ø 36 mm	ø 40 mm
03410-2613	03410-3013	03410-3413	03410-3613	03410-4013

Front rings, extended version / Colliers avants rallongés



Vorderringe mit Verlängerung. Der Klemmring sitzt in einer Verlängerung mit Pivotzapfen und wird mit zwei Innensechskantschrauben geklemmt. Mit Toleranzausgleich. Bauhöhe: 13,5 mm, Ringbreite: 15,0 mm

Verlängerung	ø 1"/26 mm	ø 30 mm	ø 34 mm	ø 36 mm
Nr. 1 V = 26 mm	03430-2626	03430-3026	03430-3426	03430-3626
Nr. 3 V = 31 mm	03430-2631	03430-3031	03430-3431	03430-3631
Nr. 5 V = 44 mm	03430-2644	03430-3044	03430-3444	03430-3644
Nr. 6 V = 56 mm	03430-2656	03430-3056	03430-3456	03430-3656



GK-Vorderringe mit Verlängerung. Der Klemmring sitzt in einer Verlängerung mit Pivotzapfen und wird mit zwei Innensechskantschrauben geklemmt. Mit Toleranzausgleich. Bauhöhe: 13,5 mm, Ringbreite: 22,0 mm

Verlängerung	ø 1"/26 mm	ø 30 mm	ø 34 mm	ø 36 mm	ø 40 mm
Nr. 7 V = 38 mm	03435-2638	03435-3038	03435-3438	03435-3638	03435-4038
Nr. 8 V = 56 mm	03435-2656	03435-3056	03435-3456	03435-3656	03435-4056

Front dovetail attachments / Prismes courts et rallongés



Vordere 70°-Aufnahmeprismen mit Pivotzapfen, ohne Toleranzausgleich. Für Zielfernrohre mit Prisma am Objektivrohr. Aus dem Vollen gefertigt. Prismenlänge: 22,0 mm

BH [mm]	
2,5	03480-7002
4,0	03480-7004
5,5	03480-7006



Vorderes 70°-Aufnahmeprisma in kurzer Ausführung, für Zielfernrohre mit Mittelrohrprisma. Mit Toleranzausgleich. Bauhöhe: 13,5 mm, Prismenlänge: 22,0 mm

03485-7013	
-------------------	--



Vordere 70°-Aufnahmeprismen mit Verlängerung. Für Zielfernrohre mit Mittelrohrprisma. Mit Toleranzausgleich. Bauhöhe: 13,5 mm, Prismenlänge: 22,0 mm

Verlängerung		
Nr. 2	V = 26 mm	03490-7026
Nr. 4	V = 31 mm	03490-7031
Nr. 5	V = 44 mm	03490-7044
Nr. 6	V = 56 mm	03490-7056



Vorderes Aufnahmeprisma, in kurzer Ausführung, für Zeiss-ZM-Zielfernrohre. Mit Toleranzausgleich. Bauhöhe: 14,0 mm, Prismenlänge: 35,0 mm

03450-4514	
-------------------	--



Vordere Aufnahmeprismen, mit Verlängerung für Zeiss-ZM-Zielfernrohre. Mit Toleranzausgleich. Bauhöhe: 14,0 mm, Prismenlänge: 35,0 mm

Verlängerung		
Nr. 7	V = 38 mm	03455-4538
Nr. 8	V = 56 mm	03455-4556



Vordere GK-Aufnahmeprismen, mit Verlängerung für Zeiss-ZM-Zielfernrohre. Besonders stabile Ausführung. Mit Toleranzausgleich. Bauhöhe: 14,0 mm, Prismenlänge: 44,0 mm

Verlängerung		
Nr. 7	V = 38 mm	03460-4538
Nr. 8	V = 56 mm	03460-4556



Vorderes Aufnahmeprisma für Swarovski SR, kurze Ausführung, mit Toleranzausgleich. Bauhöhe: 14,0 mm, Prismenlänge 35 mm

03450-5314	
-------------------	--



Vorderes Aufnahmeprisma, mit Verlängerung für Swarovski-SR. Mit Toleranzausgleich. Bauhöhe: 14 mm, Prismenlänge: 35 mm

Verlängerung		
Nr. 7	V = 38 mm	03453-4538
Nr. 8	V = 56 mm	03453-4556



Vorderes Aufnahmeprisma, mit Verlängerung für S&B-Convex-Schiene. Mit Toleranzausgleich. Bauhöhe: 14 mm, Prismenlänge: 29 mm

Verlängerung		
Nr. 7	V = 38 mm	03467-4538
Nr. 8	V = 56 mm	03467-4556

Front rings / Colliers avants



Vordere Klemmringe aus **Stahl** in Standard- und GK-Ausführung, für Verlängerungen mit Pivotzapfen.

Ringbreite [mm]	BH [mm]	für Verlängerung	ø 1"/26 mm	ø 30 mm	ø 34 mm	ø 36 mm	ø 40 mm
15	3,5	Nr. 1 / 3 / 5 / 6 / 9	03620-2603	03620-3003	03620-3403	03620-3603	
15	6,0	Nr. 1 / 3 / 5 / 6 / 9	03620-2606	03620-3006	03620-3406	03620-3606	
15	8,5	Nr. 1 / 3 / 5 / 6 / 9	03620-2608	03620-3008	03620-3408	03620-3608	
22	3,5	Nr. 7 / 8 / 10	03625-2603	03625-3003	03625-3403	03625-3603	03625-4003
22	6,0	Nr. 7 / 8 / 10	-	03625-3006	03625-3406		
22	8,5	Nr. 7 / 8 / 10	-	03625-3008	03625-3408		



Vordere Klemmringe aus hochfestem **Aluminium (Light-Ausführung)**, für Verlängerungen mit Pivotzapfen.
Bauhöhe: 3,5 mm, Ringbreite: 15 mm

ø 1"/26 mm	ø 30 mm
03620-2403	03620-2803

Dovetail attachments / Prismes



Vorderes 70°-Aufnahmeprisma, für Verlängerungen mit Pivotzapfen.

Standardausführung.

Lieferung mit Klemmschrauben.

Bauhöhe: 3,5 mm, Prismenlänge: 22 mm

für Verlängerung Nr. 2 / 4 / 5 / 6 / 9 **03650-7003**



Vorderes 45°-Aufnahmeprisma, für Verlängerungen mit Pivotzapfen.

Standardausführung. Lieferung mit zwei Klemmleisten und Innensechskantschrauben.

Bauhöhe: 4,0 mm, Prismenlänge: 35 mm

für Verlängerung Nr. 7 / 8 / 10 **03640-4504**



Vorderes 45°-GK-Aufnahmeprisma, für Verlängerungen mit Pivotzapfen. Besonders stabile Ausführung. Lieferung mit drei Klemmleisten und Innensechskantschrauben.

Bauhöhe: 4,0 mm, Prismenlänge: 44 mm

für Verlängerung Nr. 7 / 8 / 10 **03645-4504**



Vorderes Aufnahmeprisma für Verlängerungen mit Pivotzapfen für Swarovski-SR.

Standardausführung. Lieferung mit 2 Klemmleisten und Innensechskantschrauben.

Bauhöhe: 4,0 mm, Prismenlänge: 35 mm

für Verlängerung Nr. 7 / 8 / 10 **03630-5304**



Vorderes Aufnahmeprisma für Verlängerungen mit Pivotzapfen für S&B-Convex-Schiene.

Standardausführung. Lieferung mit 2 Klemmleisten und Innensechskantschrauben.

Bauhöhe: 4,0 mm, Prismenlänge: 29 mm

für Verlängerung Nr. 7 / 8 / 10 **03660-6704**

Extensions / Rallonges

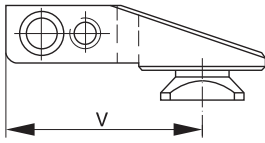

Verlängerung mit Pivotzapfen, für ERAMATIC-Schwenkmontagen.
Lieferung mit zwei Klemmschrauben M5. Bauhöhe: 10,0 mm

Verlängerung	Verwendung	
Nr. 1 V = 26 mm	Klemmringe	03601-0026
Nr. 2 V = 26 mm	70°-Aufnahmeprismen	03602-0026
Nr. 3 V = 31 mm	Klemmringe	03603-0031
Nr. 4 V = 31 mm	70°-Aufnahmeprismen	03604-0031
Nr. 5 V = 44 mm	Klemmringe, 70°-Aufnahmeprismen	03605-0044
Nr. 6 V = 56 mm	Klemmringe, 70°-Aufnahmeprismen	03606-0056
Nr. 7 V = 38 mm	GK-Klemmringe, 45°-Aufnahmeprismen Swarovski-SR, S&B-Convex-Schiene	03607-0038
Nr. 8 V = 56 mm	GK-Klemmringe, 45°-Aufnahmeprismen Swarovski-SR, S&B-Convex-Schiene	03608-0056
Nr. 9 V = 73 mm	Klemmringe, 70°-Aufnahmeprisma	03609-0073
Nr. 10 V = 73 mm	GK-Klemmringe, 45°-Aufnahmeprisma, Swarovski-SR, S&B-Convex-Schiene	03610-0073

DREHFÜSSE für BRÜCKENMONTAGEN

Pivoting base / pieds pivotants pour montages „Ponts“

Vorderer Drehfuss mit Pivotzapfen für Brückenmontage
in kurzer Ausführung; gefertigt aus Stahl.



BH	Standard	Pivotzapfen mit Übermaß
3,0	00001-284A	00002-765A
5,5	00001-285A	00002-766A
8,0	00001-286A	00002-767A



Vorderer Drehfuss mit Pivotzapfen für Brückenmontage in verlängerter Ausführung; gefertigt aus Stahl, 40 mm verlängert, BH 3,0 mm. Er dient als Austausch- teil für den bereits vorhandenen Drehfuss bei Brückenmontagen.

03612-0340

FUSSPLATTEN

Pivot bases for swing mounts / Supports de pieds avants



Fussplatten für Pivotzapfen.
Mit Drehkranz und Prisma.
Erhältlich in den Bauhöhen:
5 mm (unten offen)
6 mm (unten geschlossen)
Prisma 70° / 21,5 mm

BH [mm]

5,0	03220-0050
6,0	03220-0060

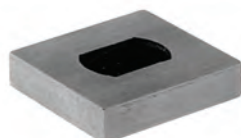

Fussplatten-Rohlinge
für eventuelle Reparaturen.
Erhältlich in den Bauhöhen:
5 mm (unten offen)
6 mm (unten geschlossen)
Länge: 26,5 mm; Breite: 25,0 mm

BH [mm]

5,0	03225-0050
6,0	03225-0060



Fussplatte für Pivotzapfen.
Mit Drehkranz und Prisma.
Unten geschlossen.
Bauhöhe: 6,0 mm
Prisma: 70° / 21,5 mm

03230-0060



Fussplatten für Pivotzapfen.
Mit Drehkranz und angefräster
Schräge für verschiedene breite
Laufschienen. Unten geschlossen.
Bauhöhe: 6,0 mm
Prisma: 70° / 28,0 mm

für Schienenbreite

10	03235-0100
12	03235-0120
14	03235-0140

Saddle bases for swing mounts / Socles de canons



Schieneneneinsatz mit vorgefräster Aussenform und Drehkranz für Pivotzapfen. Form unten geschlossen.
Für Drillinge Kaliber 12 und 16.
Länge: 38 mm

03270-0000

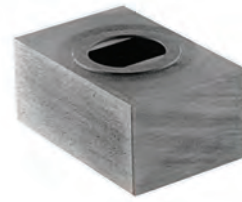

Rohling mit Drehkranz für Pivotzapfen, zur individuellen Gestaltung von Laufsockeln bzw. Schieneneneinsätzen.

25 x 18 x 38 mm
30 x 20 x 38 mm

03275-2518
03275-3020

VORDERE KLEMMRINGE

Front rings / Colliers avants

Vordere Klemmringe mit Pivotzapfen für ERAMATIC-Schwenkmontagen. Die 20 mm bzw. 25 mm breiten Ringe sind beidseitig geteilt und werden mit vier Innensechskantschrauben geklemmt.

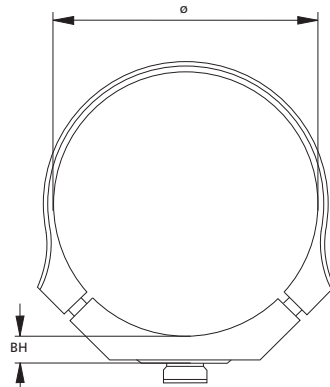

Ring-ø [mm]	Ringbreite [mm]	BH [mm]	
36,0	20	7,5	03680-3607
37,0	20	7,5	03680-3707
38,0	20	7,5	03680-3807
39,5	20	7,5	03680-3907
40,0	20	7,5	03680-4007
41,0	20	7,5	03680-4107
42,0	20	4,5	03680-4204
44,0	20	4,5	03680-4404
46,0	20	6,0	03680-4606
47,0	20	4,5	03680-4704
48,0	20	4,5	03680-4804
		7,5	03680-4807
		10,0	03680-4810
49,5	20	4,5	03680-4904
50,0	20	4,5	03680-5004
51,0	20	4,5	03680-5104
52,0	20	4,5	03680-5204

Ring-ø [mm]	Ringbreite [mm]	BH [mm]	
54,0	20	4,5	03680-5404
		7,5	03680-5407
		10,0	03680-5410
56,0	20	4,5	03680-5604
		7,5	03680-5607
57,0	20	4,5	03680-5704
		7,5	03680-5707
58,3	20	4,5	03680-5804
59,0	20	4,0	03680-5904
61,0	20	4,0	03680-6104
		7,0	03680-6107
62,0	20	4,0	03680-6204
		7,0	03680-6207
64,0	20	4,0	03680-6404
		7,0	03680-6407
65,0	20	4,0	03680-6504
80,0	25	4,0	03680-8004

UNIVERSALSCHRAUBENDREHER mit vier Klingen



Screwdriver / Tournevis

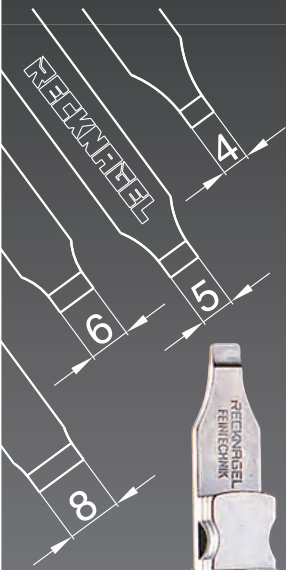

in den Farben:
 gold 00100-0020
 blau 00100-0040
 schwarz 00100-0060
 rot 00100-0080

Jeder Universal-Schraubendreher enthält vier hochfeste Klingen aus gehärtetem Werkzeugstahl mit folgenden Maßen:

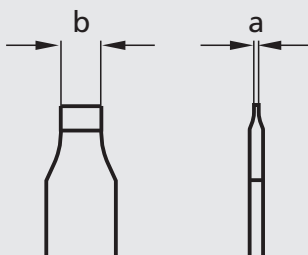

Klingenbreite (b):	4	5	6	8
Klingenstärke (a):	0,65	0,65	0,68	0,68

- optimaler Flächenkontakt durch verschiedene und planparallele Klingenstärken
- hervorragende Handhabung durch handliches Gehäuse und angenehm leichtes Gewicht
- hohe Lebensdauer und Verschleissfestigkeit
- angemessene Härte und Zähigkeit

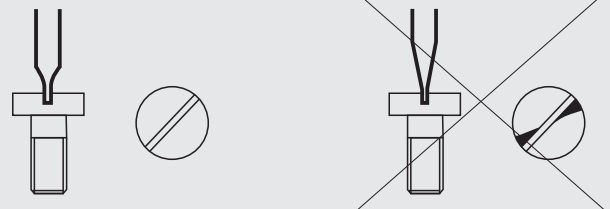

durch exakt passende planparallele Klingen nie wieder beschädigte Schraubenschlitze!

Tools / Outillage



Bürstchen und Pinsel in erprobter Qualität;
zum Säubern und Reinigen von Werkstatt, Werkzeug und Werkstück.

Bezeichnung (von oben nach unten)	Gesamt- länge [mm]	Borsten- länge [mm]	Borsten- breite [mm]	
Gewehrbürstchen	300	20	110	00050-0100
Lötlwasserpinsel	150	25	12	00050-0150
Flächenpinsel	220	45	40	00050-0200
Bohrwasserpinsel	200	35	25	00050-0250
Reinigungspinsel	210	45	25	00050-0300

Qualitäts-Treiber aus Stahl bzw. Messing. Unent-
behrliche Werkzeuge für jeden Büchsenmacher.



Treiber- ø [mm]	Treiber- länge [mm]	Gesamt- breite [mm]	
1,0 Stahl	20	74	00052-0100
1,4 Stahl	23	83	00052-0140
1,8 Stahl	39	83	00052-0180
2,4 Stahl	39	93	00052-0240
2,8 Stahl	39	93	00052-0280
3,4 Stahl	39	95	00052-0340
3,8 Stahl	39	95	00052-0380
5,8 Stahl	39	99	00052-0580
5,8 Messing	39	99	00052-0585



Treibersatz komplett,
bestehend aus 9 Treibern im Holzetui.
00052-0000

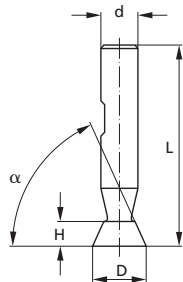

Winkelfräser
für Korn-, Visier- und Montagesockel.

Schneidenwinkel α	D [mm]	H [mm]	d [mm]	L [mm]	Zähnezahl	
60°	8,0	3,0	6,0	49,0	6	00054-6008
	16,0	6,3	12,0	60,0	8	00054-6016
	20,0	8,0	12,0	63,0	10	00054-6020
	25,0	10,0	12,0	67,0	12	00054-6025
70°	6,0	3,3	6,0	63,0	3	00054-7006
	7,9	3,7	8,0	63,0	4	00054-7008
	12,0	6,0	10,0	54,0	8	00054-7012
	14,6	8,0	12,0	60,0	8	00054-7014
	16,0	8,0	12,0	60,0	8	00054-7016
	20,0	10,0	12,0	63,0	10	00054-7020
75°	25,0	12,5	12,0	67,0	12	00054-7025
	5,0	3,0	5,0	48,0	2 doppelseitig	00054-7505
	5,0	3,0	6,35 (1/4")	63,0	2	00054-7506
	16,0	7,0	12,0	60,0	8	00054-7516



Gewindebohrer und Schneideisen für spezielle Gewinde.

Gewindebohrer	UNS 6-48	00056-0648
Schneideisen	UNS 6-48	00058-0648
Gewindebohrer-Satz	UNS 1/4"-22	00056-1422
Schneideisen	UNS 1/4"-22	00058-1422
Durchgangsloch-Gewindebohrer	M 3,5	00056-0350
Grundloch-Gewindebohrer	M 3,5	00057-0350
Schneideisen	M 3,5	00058-0350

Tools / Outilillage



Montageset für Schaftschrauben 20245-1420 und 20250-1032.

00060-0000



Mit dem Zapfensenker lässt sich die Bohrung für den äusseren Durchmesser der KDR-Buchse im Schaft herstellen. Der Spiralbohrer stellt den Kerndurchmesser für die Holzschraube her. Die Tiefe muss nachgebohrt werden.

00060-0023

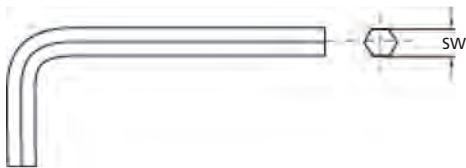

Sechskant-Schraubendreher, metrisch.

SW 0,9	00000-3620
SW 1,5	00000-3090
SW 2,0	00000-3630
SW 2,5	00000-3650
SW 3,0	00000-3660
SW 4,0	00000-3720

Sechskant-Schraubendreher, zöllig.

SW 0,05" (1,27 mm)	00000-3395
SW 5/64" (1,98 mm)	00000-3385
SW 3/32" (2,38 mm)	00000-3413
SW 1/8" (3,18 mm)	00000-3105



6-kant Winkelschraubendrehersatz, 7-teilig
Grössen: 0,9 / 1,3 / 1,5 / 2 / 2,5 / 3 / 4

00062-6047

6-kant Winkelschraubendrehersatz, 8-teilig
Grössen: 1,5 / 2 / 2,5 / 3 / 4 / 5 / 6 / 8

00062-6048



6-kant Schraubendrehersatz, 7-teilig
Grössen: 0,7 / 0,9 / 1,3 / 1,5 / 2 / 2,5 / 3

00062-6910

6-kant Schraubendrehersatz, 7-teilig
Grössen: 2 / 2,5 / 3 / 4 / 5 / 6 / 8

00062-7107

Torx-Schraubendrehersatz, 7-teilig
Grössen: TX6 / TX7 / TX8 / TX9 / TX 10 / TX15 / TX20

00062-5750



Schraubendrehersatz im Handklapphalter, 9-teilig
4x 6-kant Schraubendreher, Grössen: 3 / 4 / 5 / 6
1x Schlitzschraubendreher 4,5 x 0,6
1x Kreuzschlitzschraubendreher PH2
3x Torx-Schraubendreher, Grössen: TX10 / TX15 / TX20

00062-6062

Accessories and screws for scope mounts / Accessoires etuis pour montages

Darstellung	Bezeichnung	Abmessungen	Bestellnummer
	Klemmschraube für Klemmringe und Anschlagsschraube für Aufklippmontagen	M3,5 x 7,5 x 5	00000-0880
	Querschraube für 70°-Aufnahmeprismen mit Längsschlitz, für tiefe Senkung	M3,5 x 19,6 x 5,5	00000-0412
	Querschraube für 70°-Aufnahmeprismen mit Innensechskant, für tiefe Senkung	M3,5 x 19,6 x 5,5	00000-0415
	Kombinierte Rändelschraube für Aufschub- und Aufklippmontagen	M4 x 15 x 14	00000-0970
	Rändelmutter für Aluminium-Aufschubmontagen	M4 x 11 x 14	00000-1930
	Schieberfeder für zweiteilige Aufklippmontagen	ø5,2 x 5,5	00000-8070
	Schieberfeder für Stahl-Aufschubmontagen	ø2,4 x 7	00000-8080
	Gegendruckschraube für Aufschubmontagen-Schieber	M3 x 3	00000-2210
	Gegendruckschraube für Aufklippmontagen-Schieber	M3 x 5	00000-1660
	Gegendruckschraube für Aufklippmontagen-Schieber	M3 x 12	00000-1740
	Gegendruckschraube für Aufklippmontagen-Schieber	M3 x 16	00000-1730
	Supportschraube für Aufklippmontagen	M3,5 x 6,5	00000-1670
	Druckfeder für Aufklippmontagenschieber	ø1,9 x 4,8	00000-8140
	Gewindestift für Schlösschenfeder	M3,5 x 4	00000-0500
	Druckfeder	ø2,7 x 14	00000-8000
	Zylinderschraube für Schlösschenschieber	M3 x 4 x 4	00000-0106
	Zylinderschraube für Schlösschenschieber mit flachem Schlitz zum Nachsägen	M3 x 4,5 x 4	00000-0108
	Druckfeder für Mannlicher-Schönauer-Schlösschen	ø4,4 x 12	00000-8130
	Druckbolzen für Mannlicher-Schönauer-Schlösschen	M3 x 6 x 7	00000-1180
	Befestigungsschraube für Schienenplatten, Drillings- und Mannlicher-Schönauer-Schlösschen	M4 x 7,5 x 5,5	00000-1370
	Befestigungsschraube für Repetierbüchsen-Schlösschen und Mauser Fussplatten	M3,5 x 7,5 x 5	00000-0200
	Befestigungsschraube für Repetierbüchsen-Schlösschen	UNS 6-48 x 7,5 x 5	00000-0700
	Befestigungsschraube für Steyr-Mannlicher-Repetierbüchsen-Schlösschen	M4x0,5 x 7,5 x 5	00000-0240
	Befestigungsschraube für schmale Repetierbüchsen-Schlösschen	M2,6 x 7,5 x 3,5	00000-0310
	Supportschraube für breite Einhakmontagen-Hinterfüsse	M4 x 6,5 x 9	00000-0030
	Supportschraube für schmale Einhakmontagen-Hinterfüsse	M4 x 5,8 x 9	00000-0550
	Supportschraube für ERA-Niederzugsupport	M4 x 6 x 7	00000-0300

Accessories and screws for scope mounts / Accessoires etuis pour montages

Darstellung	Bezeichnung	Abmessungen	Bestellnummer
	Klemmschraube für Festmontagen, Brücken- und Schwenkmontagen	M5 x 15,7 x 7	00000-0342
	Anschlagschraube für Brückenmontagen mit 70°-Aufnahmeprisma	M8x0,75 x 10,4 x 9,3	00000-0930
	Klemmschieber-Befestigungsschraube für Brückenmontagen mit 70°-Aufnahmeprisma	M5 x 12 x 6,9	00000-3051
	Anschlagschraube für H7-Verschlusskörper	M3 x 6	00000-1770
	Einstellschraube für H7-Verschlusskörper	M5 x 0,5 LH x 9,8	00000-3420
	Sicherungsschraube für G9-Verschlusskörper	M3 x 5	00000-3110
	Scharnierstift für G9-Verschlusskörper	ø2 x 10	00000-3200
	Schenkelfeder für G9-Verschlusskörper		00000-8190
	Kralle für Verschlusskörper für 15mm Prisma		00001-169A
	Verbindungsschraube für V8-Hinterfüsse	M4 x 11,7 x 6	00000-2321
	Verbindungsschraube für V8-Hinterfüsse	M4 x 15,7 x 6	00000-2325
	Verbindungsschraube für V8-Hinterfüsse	M4 x 21,2 x 6	00000-2326
	Verbindungsschraube für V8-Hinterfüsse	M4 x 27,2 x 6	00000-2327
	Befestigungsschraube für Basen	M3,5 x 3,8 x 5	00000-0380
	Befestigungsschraube für Basen	M3,5 x 5,8 x 5	00000-0460
	Befestigungsschraube für Basen	UNS 6-48 x 3,8 x 5	00000-0420
	Befestigungsschraube für Basen	UNS 6-48 x 5,8 x 5	00000-0230
	Befestigungsschraube für Basen	UNS 6-48 x 5 x 5	00000-2230
	Befestigungsschraube für Steyr-Basen	M4 x 0,5 x 3,8 x 5	00000-0480
	Befestigungsschraube für Steyr-Basen	M4 x 0,5 x 5,8 x 5	00000-0450
	Befestigungsschraube für Remington 7400 / 7600-Basen	UNF 8-36 x 3,8 x 5	00000-1680
	Befestigungsschraube für Remington 7400 / 7600-Basen	UNF 8-36 x 5,8 x 5	00000-1690
	Befestigungsschraube für Voere 2185-Basen	M3,5 x 3,1 x 5	00000-2480
	Befestigungsschraube für Voere 2185-Basen	M3,5 x 4,2 x 5	00000-2470
	Befestigungsschraube für Heym-Express-Basen und Marlin-Schienen	UNF 8-40 x 5,8 x 5	00000-2340
	Befestigungsschraube für Sako-Basen	M5 x 5	00000-1830
	Befestigungsschraube für Sako-Basen	M5 x 6	00000-1820

Accessories and screws for scope mounts / Accessoires etuis pour montages

Darstellung	Bezeichnung	Abmessungen	Bestellnummer
	Justierschraube für vordere Schwenkmontagen-Basen	M3,5 x 20 x 5	00000-0940
	Konterschraube für vordere Schwenkmontagen-Basen	M3,5 x 6,5	00000-1670
	Klemmleiste für Swarovski SR Schiene	M4	00000-2226
	Klemmleiste für S&B-Convex-Schiene	M4	00000-2227
	Zentrale Klemmleiste für Montagen mit 45°-Aufnahmeprismen	M4	00000-2220
	Dezentrale Klemmleiste für Montagen mit 45°-Aufnahmeprismen	M4	00000-2221
	Vielfachmutter für Polyform-Klemmhebel	M6	00001-189A
	Polyform-Klemmhebel		00088-5700
	Dreikantmutter	M6	00001-045A
	Dreikantschlüssel		00088-0086
	Linsenflanschschraube mit Torx	M4 x 7	00000-593T
	Linsenflanschschraube mit Torx	M4 x 8	00000-594T
	Linsenflanschschraube mit Torx	M4 x 10	00000-595T
	Linsenflanschschraube mit Torx	M4 x 14	00000-596T
	Linsenflanschschraube mit Torx	M4 x 14,5	00000-597T
	Linsenflanschschraube mit Torx	M4 x 15	00000-598T
	Linsenflanschschraube mit Torx	M4 x 15,5	00000-599T
	Linsenflanschschraube mit Torx	M4 x 16	00000-600T
	Linsenflanschschraube mit Torx	M4 x 16,5	00000-601T
	Linsenflanschschraube mit Torx	M4 x 17	00000-602T
	Linsenflanschschraube mit Torx	M4 x 17,5	00000-603T
	Linsenflanschschraube mit Torx	M4 x 18	00000-604T
	Klemmschraube mit niedrigem Kopf, für 45°-Aufnahmeprismen mit Klemmleisten	M4 x 8 x 5,9	00000-2191
	Zylinderschrauben mit Innensechskant	M4 x 8 x 7	00000-2180
	Zylinderschrauben mit Innensechskant	M4 x 10 x 7	00000-1510
	Zylinderschrauben mit Innensechskant	M4 x 14 x 7	00000-1511
	Zylinderschrauben mit Innensechskant	M4 x 20 x 7	00000-1512

Darstellung	Bezeichnung	Abmessungen	Bestellnummer
	Zylinderschrauben mit Innensechskant	M4 x 25 x 7	00000-1513
	Senkschrauben mit Torx	M3 x 6	00000-144T
	Senkschrauben mit Torx	M3 x 8	00000-441T
	Senkschrauben mit Torx	M3 x 10	00000-526T
	Senkschrauben mit Torx	M3 x 12	00000-621T
	Senkschrauben mit Torx	M3 x 20	00000-670T
	Senkschrauben mit Torx	M4 x 6	00000-4850
	Senkschrauben mit Torx	M4 x 8	00000-4860
	Senkschrauben mit Torx	M4 x 10	00000-4870
	Senkschrauben mit Torx	M4 x 12	00000-4890
	Senkschrauben mit Torx	M4 x 14	00000-5460
	Senkschrauben mit Torx	M4 x 16	00000-5470
	Senkschrauben mit Torx	M4 x 20	00000-5480
	US-Senkschrauben mit Torx	UNF 8-40 x 1/4"	00000-580T
	US-Senkschrauben mit Torx	UNS 6-48 x 1/4"	00000-582T
	US-Zylinderschrauben mit Torx	UNS 6-48 x 1/4"	00000-023T
	US-Zylinderschrauben mit Torx	UNS 6-48 x 3/8"	00000-3419

RECKNAGEL

RECKNAGEL GmbH & Co. KG
Landwehr 4
D-97493 Bergtheimfeld

Bitte hier Ihre Adresse mit Telefonnummer,
Faxnummer und Ansprechpartner einfügen.

Wir bestellen gemäß Ihrer Liefer- und Garantiebedingungen:

Anzahl	Bestell-Nummer	Artikel-Bezeichnung	Einzelpreis	Gesamtpreis

Tel.: +49 (0) 97 21 / 9 48 10-0
Fax: +49 (0) 97 21 / 9 48 10-25



RECKNAGEL

RECKNAGEL GmbH & Co. KG
Landwehr 4
D-97493 Bergtheinfeld
www.recknagel.de

Tel.: +49 (0) 97 21 / 9 48 10-0
Fax: +49 (0) 97 21 / 9 48 10-25
E-mail: info@recknagel.de